

User Manual

# Geomax X-PAD ULTIMATE

English

Version 1.0

# Introduction

## Purchase

Congratulations on the purchase of the Geomax X-PAD ULTIMATE.



The content of this document is subject to change without prior notice. Ensure that the product is used in accordance with the latest version of this document.

Updated versions are available for download at the following Internet address:

<http://www.geomax-positioning.com>

## Symbols

The symbols used in this manual have the following meanings:

Type	Description
	Important paragraphs which must be adhered to in practice as they enable the product to be used in a technically correct and efficient manner.

## Trademarks

- *Bluetooth*® is a registered trademark of Bluetooth SIG, Inc.
- Windows® is a registered trademark of Microsoft Corporation in the United States and other countries

All other trademarks are the property of their respective owners.

## Available documentation

Name	Description/Format		
X-PAD Office Fusion User Manual	Overall comprehensive guide to the product and apps. Included are detailed descriptions of special software/hardware settings and software/hardware functions intended for technical specialists.	-	✓

### Refer to the following resources for all documentation/software:

- the GeoMax USB documentation card
- <http://www.geomax-positioning.com>

## GeoMax <https://portal.hexagon.com/>

Refer to the <https://portal.hexagon.com/> web page for all GeoMax X-PAD Ultimate documentation and software:

- <https://portal.hexagon.com/>

GeoMax <https://portal.hexagon.com/> offers a wide range of services and information. With direct access to GeoMax <https://portal.hexagon.com/>, you are able to access all relevant services whenever it is convenient for you.



The availability of services depends on the instrument model.



# Table of Contents

<b>1</b>	<b>Overview</b>	<b>6</b>
<b>2</b>	<b>Installation</b>	<b>7</b>
<b>3</b>	<b>The Work Screen</b>	<b>11</b>
3.1	The Main Screen	11
3.2	Receiver/Total Station Information	15
3.3	Virtual Keyboard	15
3.4	Inserting Latitude and Longitude Values	15
3.5	Inserting Fractional Feet	16
<b>4</b>	<b>Job Management</b>	<b>17</b>
4.1	Site Management	17
4.2	Job Management	18
<b>5</b>	<b>Settings</b>	<b>24</b>
5.1	Units	24
5.2	Decimals	24
5.3	Coordinates	25
5.4	GNSS	25
5.5	TPS	30
5.6	Controller	34
5.7	CAD	34
5.8	Laser Scanner	36
5.9	Miscellaneous	36
5.10	Automatic Export	36
5.11	Voice Commands	37
5.12	Commands Manager	37
5.13	X-Do!	37
5.14	Reports	38
<b>6</b>	<b>Points, Measurements, Survey Codes and GIS Features Management</b>	<b>39</b>
6.1	Topographic Points	39
6.2	Fieldbook of Measurements	45
6.3	Reference Points	48
6.4	Survey Codes	48
6.5	GIS Features	52
<b>7</b>	<b>Coordinate System</b>	<b>56</b>
7.1	Cartographic System	57
7.2	GNSS Localisation	58
7.3	TPS Coefficients	61
7.4	Base Position Adjustment	62
<b>8</b>	<b>CAD</b>	<b>63</b>
8.1	Controlling the Visualisation	64
8.2	Display Mode	65
8.3	Project Manager	69
8.4	CAD Settings	71
8.5	Import and Export	73
8.6	Object Snap	74
8.7	Drawing Functions	74
8.8	Drawing Tools for BIM	78
8.9	Creating and Editing of Points	79
8.10	Information Commands	82
8.11	Toolbar	84
<b>9</b>	<b>Instrument Settings</b>	<b>86</b>
9.1	Creating a Profile for GPS Receiver	88
9.2	Creating a Profile for Using GNSS on the Controller	92
9.3	Creating a Profile for Total Station	92
9.4	Creating a Profile for Laser Distance Meter	93
9.5	Creating a Profile for Echo Sounder	94

9.6	Creating a Profile for Cable Detector	94
<b>10</b>	<b>GPS</b>	<b>96</b>
10.1	Status	96
10.2	Starting a Base	101
<b>11</b>	<b>Survey of Points - GPS and TPS Common Functions</b>	<b>104</b>
11.1	Display Mode	104
11.2	Compass Calibration on Controller	107
11.3	Electronic Bubble	107
11.4	Survey Code Assignment	108
11.5	Quick Codes	109
11.6	GIS Features	110
11.7	Smart Drawing - Drawing During Survey	110
11.8	Average Coordinates	114
11.9	Tools and Utilities	114
<b>12</b>	<b>X-Pole - One Pole, Two Systems</b>	<b>116</b>
<b>13</b>	<b>GPS - Survey of Points</b>	<b>119</b>
13.1	Survey of Points	119
13.2	Hidden Point	125
13.3	Automatic Survey of Points	129
13.4	Static Survey of Points	130
13.5	Bathymetric Survey	131
13.6	Survey with Locators (Cable Detectors)	134
<b>14</b>	<b>GPS - Stakeout</b>	<b>135</b>
14.1	Stakeout Information	135
14.2	Common Operations in Stakeout	138
14.3	Stakeout	139
<b>15</b>	<b>TPS - Controlling the Total Station</b>	<b>148</b>
<b>16</b>	<b>TPS - Basic</b>	<b>157</b>
<b>17</b>	<b>TPS - Station Setup</b>	<b>159</b>
17.1	Orientation	161
<b>18</b>	<b>TPS - Survey of Points</b>	<b>171</b>
<b>19</b>	<b>TPS - Stakeout</b>	<b>179</b>
19.1	Stakeout Information	179
19.2	Common Operations in Stakeout	181
19.3	Stakeout	183
<b>20</b>	<b>TPS - Auto Measuring</b>	<b>191</b>
20.1	Settings	191
20.2	Procedure	193
20.3	Reports	196
<b>21</b>	<b>COGO</b>	<b>199</b>
<b>22</b>	<b>Volumes and Surfaces</b>	<b>214</b>
22.1	Surfaces	214
22.2	Volumes	218
<b>23</b>	<b>Road Stakeout</b>	<b>222</b>
23.1	Road Manager	222
23.2	Stakeout	227
23.3	Side Slopes	228
23.4	Current Position	229
23.5	X-Section Templates	230
23.6	Report	231
<b>24</b>	<b>X-PAD 365</b>	<b>232</b>
<b>25</b>	<b>External References</b>	<b>235</b>
<b>26</b>	<b>Data Import</b>	<b>238</b>



<b>27</b>	<b>Data Export</b>	<b>242</b>
<b>28</b>	<b>MEP</b>	<b>247</b>

---

# 1

## Overview

### Modules and functions

This guide provides all the information needed to use X-PAD quickly and efficiently in all situations.

Module	Description	X-PAD Ultimate Survey	X-PAD Ultimate Build
<b>GNSS</b>	Main module inside which you find all basic functions for surveying and stakeout with GPS.	✓	✓
<b>TPS</b>	Main module inside which you find all basic functions for surveying and stakeout with total station.	✓	✓
<b>TPS Robotic</b>	Add-on module allowing to use robotic and motorised total stations. Requests presence of the TPS module.	✓	✓
<b>X-Pole</b>	Add-on module that enables the simultaneous use of the GPS receiver and the total station.	✓	✓
<b>GIS</b>	Add-on module for GIS data surveying; as well as the position of the point, the software allows to record other properties freely definable by the user.	✓	-
<b>Volume</b>	Add-on module for surface stakeout, volumes and surfaces calculation.	✓	✓
<b>Road</b>	Allows the importing of road projecting data from different formats and stakeout of every element of the track according to different modes.	✓	-
<b>Auto Measuring</b>	Add-on module for automatic measurement with motorised total station.	✓	-
<b>Bathymetry</b>	Allows management of bathymetric surveys through acquisition of depth data from depth sounder and GPS or TPS position. Includes a route control.	✓	-
<b>Locator</b>	Allows connection to utilities detectors and to record depth in correspondence to GPS positions.	✓	-
<b>Build Extension</b>	Additional module that includes the X-PAD Ultimate Build features.	✓	-
<b>X-PERT</b>	Additional module that fully supports X-PERT. Details are displayed in the license status page. A warning message appears before the expiry.  New features included in the service packs are available only to customer covered by X-PERT subscription	✓	-

## 2



## Installation

### Requirements

To install the software in the device, the listed files are required.

File	Description
it.geomax.xpadsurveyultimate.apk	Installation (setup) file

### Installation step-by-step

Step	Description
1.	Download the X-PAD Ultimate software from these links: <ul style="list-style-type: none"><li>For X-PAD Ultimate Survey: <a href="http://www.lse-online.it/Download/X-PAD-Ultimate/it.geomax.xpadsurveyultimate.apk">http://www.lse-online.it/Download/X-PAD-Ultimate/it.geomax.xpadsurveyultimate.apk</a></li><li>For X-PAD Ultimate Build: <a href="http://www.lse-online.it/Download/X-PAD-Ultimate/it.geomax.xpadbuildultimate.apk">http://www.lse-online.it/Download/X-PAD-Ultimate/it.geomax.xpadbuildultimate.apk</a></li><li>For X-PAD Ultimate GO: <a href="http://www.lse-online.it/Download/X-PAD-Ultimate/it.geomax.xpadsurveygoultimate.apk">http://www.lse-online.it/Download/X-PAD-Ultimate/it.geomax.xpadsurveygoultimate.apk</a></li><li>For release notes: Release notes are available on the X-PAD 365 platform.</li></ul>
2.	Install X-PAD Ultimate software. Copy the file installation files from the PC to the controller and install directly from the controller. <ul style="list-style-type: none"><li>For X-PAD Ultimate Survey: it.geomax.xpadsurveyultimate.apk</li><li>For X-PAD Ultimate Build: it.geomax.xpadbuildultimate.apk</li><li>For X-PAD Ultimate GO: it.geomax.xpadgoultimate.apk</li></ul>
3.	Run X-PAD Ultimate. Select the applications item on the controller: <ul style="list-style-type: none"><li>For X-PAD Ultimate Survey: </li><li>For X-PAD Ultimate Build: </li><li>For X-PAD Ultimate GO: </li></ul>
4.	X-PAD Ultimate starts.

### Activation step-by-step

Running the software for the first time an activation is required. The activation is done on-line. An Internet connection is required.



## On-line activation

Step	Description
1.	Connect the device to the Internet.
2.	Select the license system: <b>EquipmentID</b> or <b>EntitlementID</b> .
3.	Enter <b>EquipmentID</b> and <b>Serial number</b> or <b>EntitlementID</b> , depending on the license.
4.	The activation is executed automatically and you are ready to start.

### Adding modules step-by-step

It is possible to add other modules to current configuration.

#### Adding modules on-line

Step	Description
1.	Start <b>X-PAD</b>  .
2.	Click  on the top left.
3.	Select the <b>License &amp; Modules</b> page.
4.	Click <b>Update license</b> .
5.	The correct license is updated with the new purchased modules.

### Transferring a X-PAD license from one controller to a new one step-by-step

Step	Description
1.	On the <b>License</b> page, click on <b>Tools</b> .
2.	Select <b>Rehost license</b> .
3.	Install X-PAD Ultimate on the new controller.
4.	Activate the license using the same license information.

### Information step-by-step

Step	Description
1.	Click  on the top left.
2.	Select the <b>About</b> page.
3.	On the page, various information is available. For example the number and type of license or the active modules.
4.	For demo licenses, it is possible to create a specific configuration by activating only the needed modules. The module activation for demo licenses is displayed.

Step	Description																											
	<p>The screenshot shows the 'X-PAD info' screen with tabs for 'ABOUT', 'LICENSE &amp;...', 'RELEASES', and 'DEVICE'. Under the 'LICENSE &amp;...' tab, there is a 'Modules' section with a list of modules and their status:</p> <table border="1"> <thead> <tr> <th>Module</th> <th>Status</th> <th>Action</th> </tr> </thead> <tbody> <tr> <td>GNSS</td> <td>ACTIVE</td> <td>X</td> </tr> <tr> <td>TPS</td> <td>ACTIVE</td> <td>X</td> </tr> <tr> <td>TPS Robotic</td> <td>ACTIVE</td> <td>X</td> </tr> <tr> <td>X-Pole</td> <td>NOT ACTIVE</td> <td>+</td> </tr> <tr> <td>Volume</td> <td>ACTIVE</td> <td>X</td> </tr> <tr> <td>Build</td> <td>ACTIVE</td> <td>X</td> </tr> <tr> <td>TPS AutoMeasuring</td> <td>ACTIVE</td> <td>X</td> </tr> <tr> <td>GIS</td> <td>NOT ACTIVE</td> <td>+</td> </tr> </tbody> </table>	Module	Status	Action	GNSS	ACTIVE	X	TPS	ACTIVE	X	TPS Robotic	ACTIVE	X	X-Pole	NOT ACTIVE	+	Volume	ACTIVE	X	Build	ACTIVE	X	TPS AutoMeasuring	ACTIVE	X	GIS	NOT ACTIVE	+
Module	Status	Action																										
GNSS	ACTIVE	X																										
TPS	ACTIVE	X																										
TPS Robotic	ACTIVE	X																										
X-Pole	NOT ACTIVE	+																										
Volume	ACTIVE	X																										
Build	ACTIVE	X																										
TPS AutoMeasuring	ACTIVE	X																										
GIS	NOT ACTIVE	+																										

## Localisation packages step-by-step

Localisation packages allow the installation of system files required to use the product in a particular country or with a particular language. Localisation packages can be requested to your GeoMax reference.

Localisation packages can contain:

- Voice messages in the corresponding language
- Coordinates correction models
- Geoid models
- Other settings

### Download directly within the program

Step	Description
1.	Start <b>X-PAD</b>
2.	Click <b>Settings</b> .
3.	Select <b>Miscellaneous</b> .
4.	Click <b>Install</b> next to the corresponding language.
5.	Click <b>Download</b> in the lower right. A list of all localisation packages available in the controller appears.
6.	Select the packages to install.
7.	Delete the corresponding files at the end of the installation procedure to gain space on the disk.

### Download using links

Step	Description
1.	Download a localisation package using a link listed in the table below.
2.	Copy the localisation package file in the folder X-PAD on the device.
3.	Start <b>X-PAD</b>
4.	Click <b>Settings</b> .
5.	Select <b>Miscellaneous</b> .
6.	Click <b>Install</b> next to the corresponding language. Select <b>Download</b> . A list of all localisation packages available in the controller appears.
7.	Select the packages to install.
8.	Delete the corresponding files at the end of the installation procedure to gain space on the disk.

## Automatic updates step-by-step



To update X-PAD, a free X-PAD 365 account is needed.

Upon starting, X-PAD checks automatically for updates. If an update is available, the appears in the top bar of the main screen.

Step	Description
1.	Click  to display the list of items available for update.
2.	Click <b>Install</b> to download the update and install.

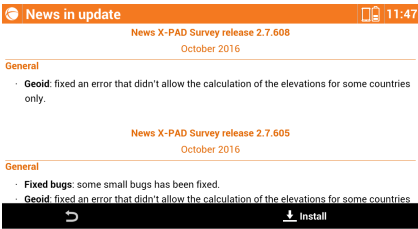

### Restoring previous version step-by-step

All updates that are downloaded and installed on the device are saved to allow eventual restoring of a previous version.

Step	Description
1.	Click  on top left.
2.	Select the <b>Releases</b> page.
3.	Select the version to restore.

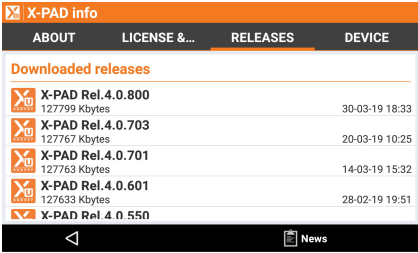

### 3

## The Work Screen

#### Description

Understanding the rules about operating with the workspace is essential to use the software quickly and efficiently.

### 3.1

#### The Main Screen

#### Description

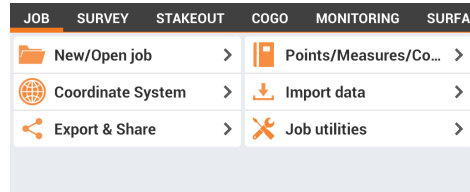







The main window is characterized by the menu that organizes the different commands based on their function.



In the lower part of the window are the general purpose commands.













Icon	Description
	Enter the graphic CAD.
	Enter the window that allows to control general status of the connected receiver and to change current profile. The icon represent the type of instrument actually connected.
	GPS rover
	GPS base
	Access to window allowing to perform simple measures with the total station and to check all measuring settings.
	Enter the window that allows to set parameters of the receiver and of the software.
	Quit software.

#### Dialog boxes



Dialog boxes are characterized by an upper bar reporting several useful information.

Object	Icon	Description
<b>X-PAD icon</b>		Clicking on this icon you access to general information about software, license, active modules and previously installed versions.
<b>Job name</b> or screen title		The name of the job is displayed in the main screen. The title of the box is displayed in the dialog box.
<b>Update available</b>		The presence of this icon indicates that an X-PAD update is available. Click the icon to see the new items contained in the update and proceed with download and installation.
<b>Weather</b>		Icon shows the current weather. Clicking the icon opens a window with weather forecast for the next hours and days is shown.
<b>Device battery</b>		Device battery charge. Clicking the icon opens a window with information about device is shown.
<b>GPS battery</b>		GPS receiver battery level. Clicking the icon opens a window with information about receiver or total station. When the remaining battery power goes lower than 20%, 10% and 5%, a message appears at the bottom of the screen to inform the user to change the battery.
<b>X-Pole</b>		Measurement with X-Pole mode. Allows you to switch to the other type of instrumentation. If you are using the GNSS receiver, you can switch to using the total station and vice versa.
<b>TPS battery</b>		Total station battery level. Clicking the icon opens a window with information about receiver or total station. When the remaining battery power goes lower than 20%, 10% and 5%, a message appears at the bottom of the screen to inform the user to change the battery.
<b>Voice command</b>		Enables/Disables the use of voice commands during operations.
<b>X-PERT</b>		Shows the status of the X-PERT subscription.
<b>Scan QR Code</b>		Shares and prints a QR code label that includes the Bluetooth address of each device. This is used to quick connect a device that has been already configured and has a proper configuration saved.











In the lower part of most part of the dialog boxes there is a bar containing commands you can use in the box.

## Standard buttons

Button	Description
	Closes the window. Tap short to return to the previous step. Tap longer on the icon to return to the main menu.



Button	Description
	Saves content of the fields and closes the window.
	Saves results obtained and continues with procedure.
	Utilities to manage window data.
	Adds a new item to data present in the window.
	Eliminates selected objects present in the window.
	In a step-by-step procedure loads the next page.
	Access to jobs available on Cloud platforms such as X-PAD 365 cloud, Microsoft OneDrive, Dropbox, Google Drive, SkyDrive or Novatron X-Site. Novatron is a manufacturer of machine control systems, and X-Site is their cloud platform to ensure connectivity and collaboration between the machines, the office and all teams. Within X-PAD Ultimate, it is possible to log in to the system and access the different projects. Data exported from X-PAD Ultimate can be uploaded to the platform and are immediately available to the machine. Downloading data from X-Site to X-PAD Ultimate is also possible.
	Activates procedure for stakeout of the point.

## Weather forecast

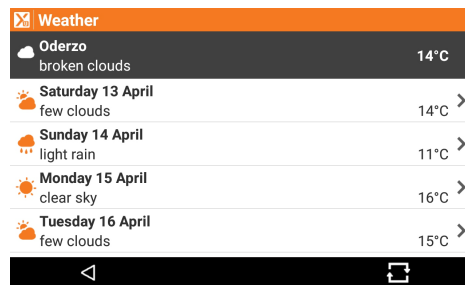

This window shows the weather forecast for next hours and next days.

Clicking on a day, the weather forecast for the hours of that day is shown.

An Internet connection is required.

Button	Description
	Update weather forecast

## Device information and support

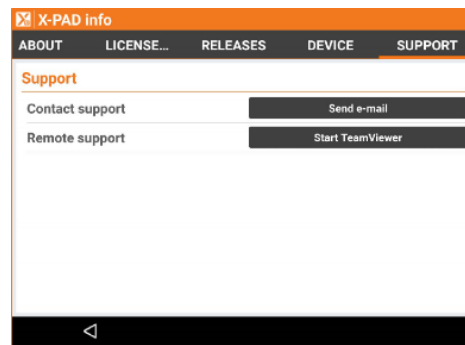

Step	Description
1.	Click  icon on the top left.
2.	Tap <b>Device</b> page. This page shows general information about device.
3.	Tap <b>Support</b> page. Send an e-mail to the support team or start a Teamviewer or AnyDesk connection in X-PAD Ultimate.

## Share and print a QR code label with Bluetooth address

Step	Description
1.	Click  icon on the top right.
2.	Select <b>Share QR Code</b> .

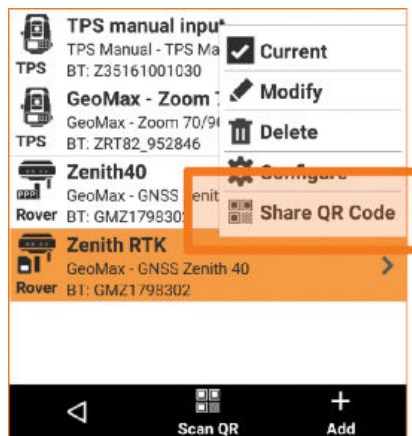

3. Scan the QR code.



4. The QR code label includes the Bluetooth address of each device.
5. Attached the QR code label on the device allowing to connect to the device.

### 3.2 Receiver/Total Station Information

**Description** This window shows general information about GPS receiver or total station connected.







### 3.3 Virtual Keyboard

**Virtual keyboard**



The virtual keyboard allows the insertion of letters, numbers and symbols.

To access the virtual keyboard from an input field, click inside the field itself.

Button	Description
	Closes the window.
	Activates the alphabetic keyboard.
	Activates the numeric keyboard.
	Restores the starting value.
	Saves content of the fields and closes the window.
	Select the quadrant for a bearing. Enter the value for the bearing without the first number which normally indicates the quadrant. Example: For 323.4549, type in 23°45'49" and press <b>SW Iso</b> . Displayed is S23°45'49"W.
	Select the chain (1 chain = 66 feet) for distances. Mainly used in the US.

### 3.4 Inserting Latitude and Longitude Values

**Description**

**Syntax**

In the input fields representing latitude and longitude values, you have to insert values according to this rule:

<sign>GG.MMSSsss

### Description of fields

Field	Description
<sign>	<ul style="list-style-type: none"><li>• + For latitude North and longitude East</li><li>• - For latitude South and longitude West</li></ul>
GG	Decimal degrees
.	Separator
MM	Two characters for minutes
SS	Two characters for seconds
ssss	Tenths of a second

### Examples

Field	Description
12°34'56.7890 N	12.34567890
12°34'56.7890 S	-12.34567890
123°45'56.7890 E	123.45567890
123°45'56.7890 W	-123.45567890

## 3.5

### Inserting Fractional Feet

#### Description

#### Syntax

Distance and coordinate values can be input as fractional feet. The accepted format is as follows:

<feet>' <inches> <fraction of an inch>"

#### Example

Field	Description
5 feet, 6 inches and one fourth	5' 6 1/4"

## 4

# Job Management

### Description

Jobs are organized in sites. You can create new sites and manage existing sites. Every new job is created in the current site. Every site can contain several jobs.

### 4.1

## Site Management

### Access

Step	Description
1.	Tap <b>JOB</b> .
2.	Tap <b>New/Open job</b> .
3.	Click 

Button	Description
<b>List.</b>	Alphabetic list of the sites
<b>Map.</b>	Sites are shown in Google Maps.



To create a new site.

### New job.





Allows to change the alphabetic order of the sites as ascending or descending.

### Setting a site step-by-step



Step	Description
1.	Tap <b>JOB</b> .
2.	Tap <b>New/Open job</b> .
3.	Click 
4.	Enter a site name.
5.	Select a line corresponding to the site to setup as current site.
6.	Go back to the window listing the jobs. Only jobs of the selected site are shown.

### Creating a site step-by-step

Step	Description
1.	Tap <b>JOB</b> .
2.	Tap <b>New/Open job</b> .
3.	Click 
4.	Click 

Field	Description
Collaborative site (X-PAD 365)	Activate this option to make the site collaborative, in order to share jobs inside in X-PAD 365. Requires a X-PAD 365 license.
<b>Site name</b>	Name of the site to create
<b>Position</b>	Address and position of the site. If the device has a valid GPS position, it is used automatically. Or select the location on the map by holding down in the desired position on the map. If your device is connected to the Internet, the corresponding address is also displayed.

## Deleting a site step-by-step

Step	Description
1.	Tap <b>JOB</b> .
2.	Tap <b>Job utilities</b> .
3.	Tap <b>Delete site</b> .
4.	Select site to delete.
	Alternatively use the context menu available when tapping on a site in the list.
	Jobs contained in the site are deleted and can not be recovered.

## 4.2

### Job Management





#### Description



The list of the jobs available on the device is displayed according to different modes.

#### Visualisation modes

Mode	Description
<b>Gallery</b>	Jobs gallery Jobs are visualised in a carousel view with the picture associated to the job or with a preview picture of the drawing. Information about the editing date of the file and the file size is included. Click a picture to open the job.
<b>List</b>	List of jobs Jobs are listed on a list together with the editing date and file size. Click the row of the corresponding job to open it.
<b>Map</b>	Visualisation of the jobs in Google Maps The position of every job is represented in Google Maps: Click the icon to get information about a job and to open it. If there are several jobs in the same area, a list is displayed.
<b>Calendar</b>	Visualisation of the jobs on the calendar Jobs are visualised on a calendar based on their creation date. To open a job, click the corresponding day. If several jobs have the same creation date, the created jobs are listed by date.

#### Description of buttons

Button	Description
	Sites management
	Carousel view
	List view
	Map view
	Calendar view

Button	Description
	Access to jobs available on Cloud platforms such as X-PAD 365 cloud, Microsoft OneDrive, Dropbox, Google Drive, SkyDrive or Novatron X-Site. Novatron is a manufacturer of machine control systems, and X-Site is their cloud platform to ensure connectivity and collaboration between the machines, the office and all teams. Within X-PAD Ultimate, it is possible to log in to the system and access the different projects. Data exported from X-PAD Ultimate can be uploaded to the platform and are immediately available to the machine. Downloading data from X-Site to X-PAD Ultimate is also possible.
	Change the alphabetic order of the jobs and the editing date as ascending or descending. Store and retrieve data in the OneDrive cloud server.
	To create a job.

### Creating a job step-by-step

Step	Description
1.	Tap <b>JOB</b> .
2.	Tap <b>New/Open job</b> .
3.	Click  .

Field	Description
<b>Site</b>	Site in which the job is created.
Collaborative job (X-PAD 365).	Activate this option to make the job collaborative, in order to synchronise it in X-PAD 365. Requires a X-PAD 365 license.
<b>Job name</b>	Name of the job to create.
<b>Reference job</b>	Create a link between the new job and an existing job. When opening the new job, the points from the reference job are loaded into the new job as reference points. The reference points can be used for all the operations such as orientation of the total station or the calibration of the GPS site.
<b>Codes library</b>	Link a library of survey codes to the job. The library has a list of codes, descriptions and symbols that can be used to describe the measured points.
<b>GIS features</b>	GIS features library to associate to the job. The library has definitions of GIS features and of properties that can be associated to the survey codes. When a point is stored, the associated GIS features are stored additionally.
<b>Annotation</b>	Descriptive notes of the job.
<b>Coordinate System</b>	The coordinates system assigned to the new job is set as default system.
<b>Position</b>	Address and position of the job. If the device has a valid GPS position, it is used automatically. Or select the location on the map by holding down in the desired position on the map. If your device is connected to the Internet, the corresponding address is also displayed.
<b>Photo</b>	The selected photo is used to represent the job in the <b>Gallery</b> . Image available on the controller or new photos taken can be used.

### Opening a job step-by-step

Step	Description
1.	Tap <b>JOB</b> .
2.	Tap <b>New/Open job</b> .
3.	Select the site containing the job to open.
4.	Select the job from the list, from Google Maps or from the calendar.

### Opening a job saved on a Cloud server step-by-step

Step	Description
1.	Tap <b>JOB</b> .
2.	Tap <b>New/Open job</b> .
3.	Select the cloud server on which the jobs are saved.
4.	Login to the server, if required.
5.	Select the job to open. The job is copied into the current site and can be opened.



### Job properties step-by-step

Step	Description
1.	Tap <b>JOB</b> .
2.	Tap <b>Job utilities</b> .
3.	Tap <b>Job properties</b> .

Field	Description
<b>Site</b>	Site in which the job is created.
<b>Job name</b>	Name of the job to create.
<b>Reference job</b>	Create a link between the new job and an existing job. When opening the new job, the points from the reference job are loaded into the new job as reference points. The reference points can be used for all the operations such as orientation of the total station or the calibration of the GPS site.
<b>Codes library</b>	Link a library of survey codes to the job. The library has a list of codes, descriptions and symbols that can be used to describe the measured points.
<b>GIS features</b>	GIS features library to associate to the job. The library has definitions of GIS features and of properties that can be associated to the survey codes. When a point is stored, the associated GIS features are stored additionally.
<b>Annotation</b>	Descriptive notes of the job.
<b>Coordinate System</b>	The coordinates system assigned to the new job is set as default system.
<b>Position</b>	Address and position of the job. If the device has a valid GPS position, it is used automatically. Or select the location on the map by holding down in the desired position on the map. If your device is connected to the Internet, the corresponding address is also displayed.
<b>Photo</b>	The selected photo is used to represent the job in the <b>Gallery</b> . Image available on the controller or new photos taken can be used.

### Copying or sending a copy of the current job step-by-step

#### Copying a job

Step	Description
1.	Tap <b>JOB</b> .
2.	Tap <b>Job utilities</b> .
3.	Tap <b>Save a copy of the job</b> .
4.	Save the open job and all linked files.
	Tap <b>Copy to another site</b> to copy the job to another site.
	Tap <b>Move to another site</b> to move the job to another site.



## Description of fields

Field	Description
<b>File name</b>	Name to assign to the copied job.
<b>Device/Cloud</b>	Save the copy of the job on the device or on a Cloud server.
<b>Share file</b>	Use services available on an Android device such as sending file by e-mail, by Wi-Fi, Bluetooth, X-PAD 365, Google Drive, DropBox or OneDrive.

## Save a job

Step	Description
1.	Tap <b>List</b> .
2.	Tap and hold <b>Job name</b> .
3.	Tap <b>Save as</b> .
4.	Save the open job and all linked files.
5.	The just saved job can be opened directly.

Field	Description
<b>File name</b>	Name to assign to the copied job.
<b>Cloud</b>	Save the copy of the job on a Cloud server. This option is available by holding the job name and selecting <b>Save as</b> .

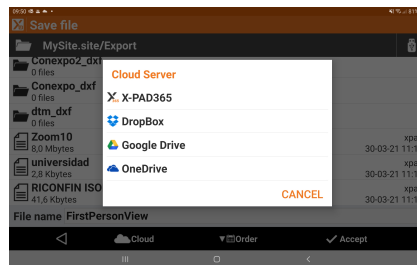

Navigate through the folders.

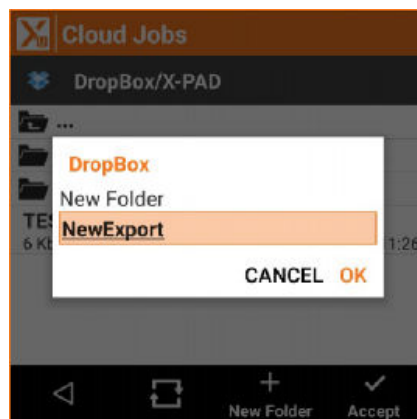

Create new folders and store the data there.

Button	Description
	Store a copy of the job in a memory unit connected to the device. This option is available by holding the job name and selecting <b>Save as</b> .

Button	Description
	Store a copy of the job in a device folder. This option is available by holding the job name and selecting <b>Save as</b> .

### Deleting a job step-by-step

#### Delete selected jobs

Step	Description
1.	Tap <b>JOB</b> .
2.	Tap <b>Job utilities</b> .
3.	Tap <b>Delete job</b> .
4.	Select the jobs to be deleted. The selected job files and all linked files are deleted.

#### Delete one job

Step	Description
1.	Tap <b>List</b> .
2.	Hold down on the job name.
3.	Tap <b>Delete</b> .
4.	The selected job file and all linked files are deleted.

### Renaming a job step-by-step

Step	Description
1.	Tap <b>List</b> .
2.	Hold down on the job name.
3.	Tap <b>Rename</b> .
4.	The selected job file and all linked files are renamed.

### Compact and repairing a job step-by-step

This option performs a compaction and eventually a restoring of an existing job when many data are delete or when the job is corrupt.

Step	Description
1.	Tap <b>JOB</b> .
2.	Tap <b>Job utilities</b> .
3.	Tap <b>Compact and restore job</b> .
4.	Select a job. A copy of the original job is created.

### Restoring a job step-by-step

This option allows to import the RAW file of another job into in a job which is damaged and cannot be opened anymore.

Step	Description
1.	Tap <b>JOB</b> .
2.	Tap <b>Job utilities</b> .
3.	Tap <b>Restore job</b> .
4.	Select the RAW file of the job to restore.
5.	Assign a name to the new job which will contain the restored data.

## File extensions and folder name

Extension or folder	Description
<b>*.GFD4</b>	Every job is saved in a file with *.GFD4 extension.
<b>*.GFD4_BAK</b>	When opening a job, a copy is created automatically with *.GFD4_BAK extension.
<b>*.RAW</b>	When closing a job, the RAW file is created with *.RAW extension; The RAW file is a text file reporting all essential data of the job: topographic points and measures. The RAW file can be used by third-party software to import data.
<b>&lt;name of the job&gt;_IMG</b>	Sketches linked to points or to the measurement fieldbook are saved in a sub-folder of the job folder. The name of the sub-folder is <name of the job>_IMG.

## Conversion of X-PAD Survey 3 files step-by-step

Jobs created with X-PAD Survey 3, the previous version of X-PAD, are shown in the work list with the icon .

Jobs created with X-PAD Survey 3 must be converted before opening.

The conversion keeps the original job and creates a copy of the job in the new format.

Step	Description
1.	Tap <b>JOB</b> .
2.	Tap <b>New/Open job</b> .
3.	Select the job file to convert.
4.	Press <b>Yes</b> to execute the conversion.

## 5

## Settings

### Description

The software operations are subjected to a series of parameters and options that are fully customisable.

### Saving and loading settings step-by-step

All settings can be saved:

- As default settings for every new job
- With a name for loading when necessary for a job

#### Save settings as default

Step	Description
1.	Tap <b>Settings</b> .
2.	Click  .
3.	Click select <b>Save settings as default</b> .
4.	The current settings are saved as default. Every new job uses these settings automatically.

#### Save settings as

Step	Description
1.	Tap <b>Settings</b> .
2.	Click  .
3.	Tap <b>Save settings with name</b> .
4.	Insert a name to be used to save current settings.

#### Load settings

Step	Description
1.	Tap <b>Settings</b> .
2.	Click  .
3.	Tap <b>Load settings</b> .
4.	Select a file to load in current job.

### 5.1

#### Units

### Description

The page allows to set the units for measurements to use for every type of data.

Step	Description
1.	Tap <b>Settings</b> .
2.	Tap <b>Units</b> .

### 5.2

#### Decimals

### Description

The page allows to set the number of decimals to show for every type of data.

Step	Description
1.	Tap <b>Settings</b> .
2.	Tap <b>Decimals</b> .

## 5.3

## Coordinates

### Description

The page allows:

- Setting the symbols to mark the abscissa, the ordinates and the elevations
- Setting the order of visualisation and insertion of abscissa and ordinates
- Setting the direction of the ordinates  
The default direction of the ordinates is toward North but in some countries it is inverted.

Step	Description
1.	Tap <b>Settings</b> .
2.	Tap <b>Coordinates</b> .

## 5.4

## GNSS

### Description

The tab allows:

- Setting several parameters controlling the acquisition of the positions of the GPS receiver
- Setting the functioning modes



Step	Description
1.	Tap <b>Settings</b> .
2.	Tap <b>GNSS</b> .

### Tab GNSS

Step	Description
1.	Tap <b>Settings</b> .
2.	Tap <b>GNSS</b> .
3.	Tap <b>GNSS</b> .

### Accuracy check

Field	Description
<b>Store only in Fixed</b>	The epochs recording is done only if the receiver is in fixed position.
<b>Accuracy check</b>	Activates accuracy check. GPS epoch is accepted if the current precision satisfies the preset precision conditions.
<b>RTK age check</b>	Enables control of receiving corrections. When activated, corrections must be received within the time set to store the point.
<b>Max age (secs)</b>	Sets the maximum time that the new RTK fix needs to be received.
<b>H</b>	Maximum horizontal precision for an acceptable GPS epoch.
<b>V</b>	Maximum vertical precision (elevation) for an acceptable GPS epoch.
<b>DOP check</b>	Activates the check on DOP value. The GPS epoch is accepted if the DOP value is lower than the preset one.
<b>Max DOP</b>	Maximum DOP value to make acceptable the GPS epoch.
<b>Satellites check</b>	Activates the number of satellites checked. The GPS epoch is accepted if the number of tracked satellites is more than the minimum value preset.
<b>Min Satellites</b>	Minimum number of satellites required for an acceptable GPS epoch.

Field	Description
<b>Sensors mode</b>	<p>It is possible to set the use of different types of sensors in surveying and stakeout phases:</p> <ul style="list-style-type: none"> <li>• <b>None:</b> No sensor</li> <li>• <b>E-Bubble</b> Activates the use of an electronic bubble of the controller. The GPS epoch is accepted if the electronic bubble is inside the tolerance range.</li> <li>• <b>E-bubble (GNSS receiver)</b> Available for Zenith 35. Activates the use of an electronic bubble of the GPS receiver (if present). The GPS epoch is accepted if the electronic bubble is inside the tolerance range.</li> <li>• <b>Tilted pole (GNSS receiver)</b> Available for Zenith 35. Activates the use of tilt and compass sensors of the GPS receiver (if present). Sensors allow to calculate the position of the point even if the pole is not vertical.</li> </ul> <p> To turn off the e-bubble temporarily while surveying, tap once into the survey panel and select <b>Deactivate</b>. The position is stored without any check.</p>
<b>Max error (2m pole)</b>	Maximum error acceptable outside the bubble considering a 2 metre pole.
<b>Localization area check</b>	<p>Activates the GPS localisation zone check.</p> <p>If a coordinate system defined by a localisation on more than two points is set, the software verifies if the receiver position is inside the localisation zone.</p> <p>If the current position is outside of the localisation zone, an icon is displayed on the coordinates panel in survey and stakeout windows.</p> <p> N 45°57'09.5371" E 12°29'40.3363" 71.451m </p> <p>The localisation zone is drawn in the graphic window.</p>
<b>Average coords</b>	Activates the calculation of the average point coordinates when measured multiple times.
<b>Horizontal</b>	Tolerance for distances and elevations
<b>Vertical</b>	If a measurement differs from the average value more than the defined tolerance, it is highlighted in the list of measurements.

#### Miscellaneous

Field	Description
<b>GNSS position symbol</b>	Select the symbol that represents the position of the GNSS receiver during surveying.
<b>GNSS symbol 3D</b>	Enables the display of a 3D symbol for the instrument, when the 3D view is active in the survey and stakeout graphics window.
<b>Configure always GNSS receiver</b>	Enables the complete reconfiguration of the receiver with the current profile at each connection with the controller.
<b>Photos store mode</b>	<p>Decide which pictures to store in case pictures are taken during the survey.</p> <ul style="list-style-type: none"> <li>• <b>All photos:</b></li> <li>• <b>Only low res. photo</b></li> <li>• <b>Only high res. photo</b></li> <li>• <b>Only geo tagged photo</b></li> </ul>

#### Tab Survey

The tab allows to set the main functioning parameters for the different GPS survey modes.

Step	Description
1.	Tap <b>Settings</b> .
2.	Tap <b>GNSS</b> .
3.	Tab <b>Survey</b> .

## GPS Survey

Field	Description
<b>Measure mode</b>	<b>Automatic</b> Measurement ends automatically after the preset number of seconds.
<b>Time on point (sec)</b>	Seconds of acquisition of the position of the point For every second, a number of epochs equal to the frequency is saved in the GPS profile. For example: 1 Hz frequency = One position (epoch) per second, 5 Hz = Five positions (epochs) per second.  To decrease the occupation time to one single epoch: Click the corresponding icon to reduce the occupation time to shorter than one second.
<b>Time on Control Point (sec)</b>	Sets the seconds of acquisition of the position for a point of type Master point.

## Automatic survey

Field	Description
<b>Measure mode</b>	Mode to use for the automatic points survey: <ul style="list-style-type: none"><li>• <b>Time</b> Position is acquired at intervals of time.</li><li>• <b>Distance 2D</b> Position is acquired at intervals of horizontal distance.</li><li>• <b>Distance 3D</b> Position is acquired at intervals of three-dimensional distance.</li><li>• <b>Distance 2D Plus</b> Position is acquired at intervals of horizontal distance and height difference according to settings.</li><li>• <b>Stop &amp; Go</b> Position is acquired according to <b>Stop &amp; Go</b> mode. When the antenna remains static, the software begins to acquire the position.</li></ul>
<b>Measure every (sec)</b>	In case of <b>Time</b> mode: Defines the interval of time between the automatic acquisition of positions.
<b>Distance 2D</b>	In case of <b>Distance 2D</b> mode: Defines the interval of horizontal distance that must be between the position to acquire and the position previously acquired.
<b>Distance 3D</b>	In case of <b>Distance 3D</b> mode: Defines the interval of three-dimensional distance that must be between the position to acquire and the position previously acquired.
<b>Distance 2D Plus</b>	In case of <b>Distance 2D Plus</b> mode: Defines the interval of horizontal distance and the height difference that must be between the position to acquire and the position previously acquired. The point is acquired when one of the values is exceeded.
<b>Stop time (sec)</b>	In case of <b>Stop &amp; Go</b> mode: Defines the time to stay on the point to allow the acquisition of position.
<b>Max antenna movement</b>	In case of <b>Stop &amp; Go</b> mode: Represents the maximum movement allowed to consider a static antenna. When the software identifies that the antenna remains in static position with a movement lower than the maximum value, the acquisition of the position begins for the defined time.

## Post-Processing survey

Field	Description
<b>Measure mode</b>	<b>Automatic</b> Measurement ends automatically after the preset number of seconds.

### Survey codes

Field	Description
<b>Numeric codes</b>	Activates a preferential use of numeric codes concerning survey codes. The virtual keyboard appearing is the numeric one.
<b>Measure after Quick Code</b>	When activated, measurements start immediately automatically after the selection of the Quick Code.
<b>Add new codes to library</b>	When activated, a code used during the surveying that is not store in the library yet, is added automatically.
<b>GIS line attributes for all points</b>	When activated, GIS attributes are required for each point of the line. When not activated, GIS attributes are only required for the first point of the line.

### Average coordinates

Field	Description
<b>Average coords</b>	Activates the calculation of the average point coordinates when measured multiple times.
<b>Max H</b>	Tolerance for distances and elevations
<b>Max V</b>	If a measurement differs from the average value more than the defined tolerance, it is highlighted in the list of measurements.

### Miscellaneous

Field	Description
<b>Survey display mode</b>	Sets the default display mode of the survey graphics window performed with GNSS. <ul style="list-style-type: none"><li>• <b>2D (walk direction)</b> Displays items of drawing and surveying in 2D oriented mode according to the direction of the antenna.</li><li>• <b>2D (north)</b> Displays items of drawing and surveying in 2D oriented mode according to North.</li><li>• <b>3D (walk direction)</b> Displays items of drawing and surveying in 3D oriented mode according to the direction of the rover.</li><li>• <b>Map (Google or others)</b> Displays a reference map in surveying operation.</li><li>• <b>Augmented Reality</b> Displays the items of drawing and surveying in the current view of the device camera.</li></ul>

### Tab Stakeout

The tab allow to set the functioning and control parameters for the GPS stakeout.

Step	Description
1.	Tap <b>Settings</b> .
2.	Tap <b>GNSS</b> .
3.	Tab <b>Stakeout</b> .

### Tolerance

Field	Description
<b>Distance tolerance</b>	Maximum horizontal distance between current position and stakeout position. If the distance between current position and position to reach is lower than or equal to the tolerance, the software reports the reaching of stakeout position.



Field	Description
<b>Elevation tolerance</b>	Maximum acceptable difference between current elevation and stakeout elevation If the elevation difference is lower than or equal to the tolerance, the software reports the reaching of the position in elevation.

#### Miscellaneous

Field	Description
<b>Vocal Info</b>	Activates the vocal information during the stakeout operations.
<b>Confirm before Store</b>	Allows checking the stakeout position before proceeding to saving the new point on position to stakeout. When disabled, the stakeout point is saved without any further request.
<b>Reference GNSS</b>	Defines the reference to which the information to reach the stakeout position with GPS is provided. References can be: <ul style="list-style-type: none"> <li>• <b>North</b> Information is provided referring to North. Turn the controller toward North and follow indications.</li> <li>• <b>Sun</b> Information is provided referring to the sun. Turn the controller toward the sun and follow indications.</li> <li>• <b>Point</b> Information is provided referring to a reference point previously defined. Turn the controller toward the point and follow indications.</li> </ul>
<b>Compass limit</b>	Distance determining the automatic change of visualisation of the stakeout information. If the distance of the receiver from the point to stakeout is more than the preset value, an arrow appears indicating the direction. If the distance of the receiver from the point to stakeout is lower than the preset value, a stakeout sketch appears with the reference to North, to the sun or to a point.
<b>Stakeout display mode</b>	Sets the default display mode of the stakeout graphics window performed with GNSS. <ul style="list-style-type: none"> <li>• <b>2D (walk direction)</b> Displays items of drawing and staking out in 2D oriented mode according to the direction of the antenna.</li> <li>• <b>2D (north)</b> Displays items of drawing and staking out in 2D oriented mode according to North.</li> <li>• <b>3D (walk direction)</b> Displays items of drawing and staking out in 3D oriented mode according to the direction of the rover.</li> <li>• <b>Map (Google or others)</b> Displays a reference map in staking out operation.</li> <li>• <b>Augmented Reality</b> Displays the items of drawing and staking out in the current view of the device camera.</li> </ul>
<b>Stakeout from CAD</b>	Select the stakeout elements from CAD: <ul style="list-style-type: none"> <li>• <b>None</b></li> <li>• <b>Stakeout object</b></li> <li>• <b>Reference line</b></li> </ul>

#### Tab Points name

The window allows the customisation of point names according to the type of point. If the point name is composed of letters and numbers, the program only increases the numerical part during operations.

Step	Description
1.	Tap <b>Settings</b> .
2.	Tap <b>GNSS</b> .
3.	Tab <b>Points name</b> .

### Example

Field	Description
Survey	P1 The name of all surveying points starts with the "P" and the number increases from 1 (P1, P2, P3, P4, ...).

## 5.5

### TPS

#### Description

The tab allows to set the total station survey functioning and control parameters.

Step	Description
1.	Tap <b>Settings</b> .
2.	Tap <b>TPS</b> .

#### Tab TPS

Step	Description
1.	Tap <b>Settings</b> .
2.	Tap <b>TPS</b> .
3.	Tab <b>TPS</b> .

#### Accuracy check

Field	Description
<b>Horiz.angle (sec)</b>	Tolerance for distances and elevations
<b>Vert.angle (sec)</b>	If a measurement differs from the average value more than the defined tolerance, it is highlighted in the list of measurements.
<b>Distance</b>	Maximum acceptable error in distance for multiple measurements in face 1 and face 2.
<b>Elevation</b>	Maximum acceptable error in elevation for multiple measurements in face 1 and face 2.
<b>E-Bubble check (X-TILT)</b>	Activates the use of electronic bubble. The electronic bubble is visualised in the survey and stakeout windows.
<b>Max error (2m pole)</b>	Maximum error acceptable outside the bubble considering a 2 metre pole.

#### Prism lost search strategy

Field	Description
<b>Search after lost</b>	Activates the automatic search of the prism after the total station lost it. When the prism is lost, the TPS goes in prediction mode for 3 seconds. After that time, if the prism is not yet recognised, the automatic search starts immediately. The searching modes are: <ul style="list-style-type: none"><li>• <b>None</b> No action</li><li>• <b>360° search</b> A 360° search of the prism is started.</li><li>• <b>Win + 360°</b> A window search in the zone where the prism is lost is started followed by a 360° search.</li><li>• <b>Return to last pos.</b> The station goes in the last position where the prism was locked.</li><li>• <b>Use controller's GNSS</b> Use the GPS location of the controller to search for the prism.</li></ul>

## Miscellaneous

Field	Description
<b>TPS symbol 3D</b>	Enables the display of a 3D symbol for the instrument, when the 3D view is active in the survey and stakeout graphics window.
<b>Photos store mode</b>	The system can store: <ul style="list-style-type: none"> <li>• All photos</li> <li>• Only low resolution photos</li> <li>• Only high resolution photos</li> <li>• Only Geo tagged photos</li> </ul>
<b>Target height immediate keyboard</b>	When enabled and the target height is selected, a keyboard appears from which new values can be inserted. Otherwise, the value for the target height must be selected from a table.
<b>Free station in F1/F2</b>	Enables the measurement of the reference point in free station setup in direct and reverse face in order to assure maximum accuracy.

## Tab Survey

Step	Description
1.	Tap <b>Settings</b> .
2.	Tap <b>TPS</b> .
3.	Tab <b>Survey</b> .

## Number of measurements

Field	Description
<b>Standard</b>	Sets the number of measurements that the TPS must perform before storing a point.
<b>Control point</b>	Sets the number of measurements that the TPS must perform before storing a point of type control point.

## Automatic survey

Field	Description
<b>Measure mode</b>	Mode to use for the automatic points survey: <ul style="list-style-type: none"> <li>• <b>Time</b> Position is acquired at intervals of time.</li> <li>• <b>Distance 2D</b> Position is acquired at intervals of horizontal distance.</li> <li>• <b>Distance 3D</b> Position is acquired at intervals of three-dimensional distance.</li> <li>• <b>Distance 2D Plus</b> Position is acquired at intervals of horizontal distance and height difference according to settings.</li> <li>• <b>Stop &amp; Go</b> Position is acquired according to <b>Stop &amp; Go</b> mode. When the antenna remains static, the software begins to acquire the position.</li> </ul>
<b>Measure every (sec)</b>	In case of <b>Time</b> mode: Defines the interval of time among the automatic acquisition of positions.
<b>Distance 2D</b>	In case of <b>Distance 2D</b> mode: Defines the interval of horizontal distance that must be between the position to acquire and the position previously acquired.
<b>Distance 3D</b>	In case of <b>Distance 3D</b> mode: Defines the interval of three-dimensional distance that must be between the position to acquire and the position previously acquired.

Field	Description
<b>Distance 2D Plus</b>	In case of <b>Distance 2D Plus</b> mode: Defines the interval of horizontal distance and the height difference that must be between the position to acquire and the position previously acquired. The point is acquired when one of the values is exceeded.
<b>Stop time (sec)</b>	In case of <b>Stop &amp; Go</b> mode: Defines the time to stay on the point to allow the acquisition of position.

#### Survey codes

Field	Description
<b>Numeric codes</b>	Activates a preferential use of numeric codes concerning survey codes. The virtual keyboard appearing is the numeric one.
<b>Measure after Quick Code</b>	When activated, measurements start immediately automatically after the selection of the Quick Code.
<b>Add new codes to library</b>	When activated, a code used during the surveying that is not store in the library yet, is added automatically.

#### Average coordinates

Field	Description
<b>Average coords</b>	Activates the calculation of the average point coordinates when measured multiple times.
<b>Max H</b>	Tolerance for distances and elevations
<b>Max V</b>	If a measurement differs from the average value more than the defined tolerance, it is highlighted in the list of measurements.

#### Miscellaneous

Field	Description
<b>Survey display mode</b>	Sets the default display mode of the survey graphics window performed with the total station. <ul style="list-style-type: none"> <li>• <b>2D (walk direction)</b> Displays items of drawing and surveying in 2D oriented mode according to the direction of the total station.</li> <li>• <b>2D (north)</b> Displays items of drawing and surveying in 2D oriented mode according to North.</li> <li>• <b>3D (walk direction)</b> Displays items of drawing and surveying in 3D oriented mode according to the direction of the TPS. The program shows the direction based on the position of the controller, which can be behind the TPS or behind the pole.</li> </ul>

#### Tab Stakeout

The tab allow to set the functioning and control parameters for the total station stakeout.

Step	Description
1.	Tap <b>Settings</b> .
2.	Tap <b>TPS</b> .
3.	Tab <b>Stakeout</b> .

## Tolerance

Field	Description
<b>Distance tolerance</b>	Maximum horizontal distance between current position and stakeout position. If the distance between current position and position to reach is lower than or equal to the tolerance, the software reports the reaching of stakeout position.
<b>Elevation tolerance</b>	Maximum acceptable difference between current elevation and stakeout elevation If the elevation difference is lower than or equal to the tolerance, the software reports the reaching of the position in elevation.

## Miscellaneous

Field	Description
<b>Vocal Info</b>	Activates the vocal information during the stakeout operations.
<b>Confirm before Store</b>	Allows checking the stakeout position before proceeding to saving the new point on position to stake out. When disabled, the stakeout point is saved without any further request.
<b>Tracking mode</b>	When activated, the tracking mode is always set with the continuous surveying mode.
<b>Reference TPS</b>	Defines the reference to which the information to reach the stakeout position with the total station is provided. References can be: <ul style="list-style-type: none"> <li>• <b>Target</b> Information is provided considering the operator on the target looking toward the total station.</li> <li>• <b>Total station</b> Information is provided considering the operator on the TPS position.</li> <li>• <b>North</b> Information is provided referring to North.</li> </ul>
<b>Turn to stakeout point</b>	When activated, the motorised total station turns automatically toward the stakeout point when selected.
<b>Stakeout display mode</b>	Sets the default display mode of the stakeout graphics window performed with the total station. <ul style="list-style-type: none"> <li>• <b>2D (TPS direction)</b> Displays items of drawing and staking out in 2D oriented mode according to the direction of the total station.</li> <li>• <b>2D (north)</b> Displays items of drawing and staking out in 2D oriented mode according to North.</li> <li>• <b>3D (walk direction)</b> Displays items of drawing and staking out in 3D oriented mode according to the direction of the TPS. The program shows the direction based on the position of the controller, which can be behind the TPS or behind the pole.</li> </ul>
<b>Stakeout from CAD</b>	Select the stakeout elements from CAD: <ul style="list-style-type: none"> <li>• <b>None</b></li> <li>• <b>Stakeout object</b></li> <li>• <b>Reference line</b></li> </ul>

## Tab Points name

The window allows the customisation of point names according to the type of point. If the point name is composed of letters and numbers, the program only increases the numerical part during operations.

Step	Description
1.	Tap <b>Settings</b> .
2.	Tap <b>TPS</b> .
3.	Tab <b>Points name</b> .

## Example

Field	Description
<b>Survey</b>	Example: P1 The name of all surveying points starts with the "P" and the number increases as defined in the field <b>Increment</b> .
<b>Increment</b>	Define the rule for the name of the next point. It is possible to specify an increment other than 1, even a negative one.

## 5.6

### Controller

#### Description

#### Zenius 800 controller

The tab allows to set the F1 and F2 hardware button on the Zenius 800 controller with specific functions in order to be faster and more productive in the field.

Step	Description
1.	Tap <b>Settings</b> .
2.	Tap <b>F1/F2 keys settings</b> .
3.	Define for survey and stakeout separately: <ul style="list-style-type: none"><li>• <b>F1/F2 keys</b> Function to execute when pressing the F1 hardware button.</li><li>• <b>F1/F2 keys</b> Function to execute when pressing the F2 hardware button.</li></ul>



#### Juniper Allegro3 Android controller

The Juniper Allegro3 Android controller is supported by X-PAD Ultimate.

Many of the physical keys can be used to control the software. The six functions keys can be customised as shortcut to activate some commands and options.

#### Samsung Active Android controller

The Samsung Active Android controller has an active button that can be customised to control the software

## 5.7

### CAD

#### Description

The tab allows to set different display parameters of the CAD workspace.

Step	Description
1.	Tap <b>Settings</b> .
2.	Tap <b>CAD</b> .

#### Tab Survey

Step	Description
1.	Tap <b>Settings</b> .
2.	Tap <b>CAD</b> .
3.	Tab <b>Survey</b> .

Field	Description
<b>Topographic points</b>	Turns on/off the display of stored points.
<b>Reference points</b>	Turns on/off the display of reference points.
<b>Stakeout points</b>	Turns on/off the display of stakeout points.
<b>Measure lines</b>	Turns on/off the display of measure lines.
<b>Drawing by codes</b>	Turns on/off the display of drawing by codes.
<b>Parcels</b>	Turns on/off the display of parcels.

## Tab Points

### Point display filters

Field	Description
<b>Point name</b>	Turns on/off the display of the point name.
<b>Point elevation</b>	Turns on/off the display of the point elevation.
<b>Point code</b>	Turns on/off the display of the point code.
<b>Point description</b>	Turns on/off the display of the point description.
<b>Point symbol</b>	Turns on/off the display of the point symbol.

### Point symbol and label size

Field	Description
<b>Label with background</b>	Turns on/off the display of the label background.
<b>Point size</b>	Allows to set the size used to display the text of labels.
<b>Auto size labels in 3D</b>	Turns on/off automatic text size management when 3D display is active. If the option is active, the size of the text changes depending on the distance. The closest text is displayed with a larger size than text further away.

## Tab CAD

### CAD display filter

Field	Description
<b>Main drawing</b>	Turns on/off the display of drawing elements.
<b>External references</b>	Turns on/off the display of elements stored in the external reference.
<b>Use linetypes</b>	Turns on/off the display of line types associated with the drawing elements.
<b>Line double thickness</b>	Turns on/off the display of drawing elements with a doubled thickness.
<b>Mono color drawing</b>	Turns on/off the display of colours for drawing element.
<b>Autocenter in drawing</b>	Turns on/off the automatic centring of the drawing. During drawing operations, each time a CAD location is set, it is shown in the centre of the graphical window.
<b>Grid</b>	Turns on/off the display of the grid in the CAD window.
<b>Grid step</b>	Sets the steps of the grid.

### AR settings

Field	Description
<b>Height from ground</b>	Sets the height of the point of view, when augmented reality display mode is active.
<b>Radar</b>	Turns on the display of the plan view in the bottom right of a panel.

## 5.8

### Laser Scanner

#### Description

Step	Description
1.	Tap <b>Settings</b> .
2.	Tap <b>Laser scanner</b> .

Field	Description
<b>Draw scan zone</b>	Enables drawing of the scanning zone. The drawing consists in a circle having the centre in the scan points.
<b>Scan radius</b>	Radius to use for the drawing of the scan area. Corresponds to the average range of the scanner.
<b>Prefix scan center</b>	Prefix with which the scan centres have to be identified. The scan zones are drawn in relation to the scan centres.
<b>Prefix target</b>	Prefix used to indicate the target points.
<b>Scanner control</b>	Enables the scanner control mode directly from X-PAD. In the survey menu, an item is added allowing to access to web page to control the scanner (in case of GeoMax Zoom300 scanner).

## 5.9

### Miscellaneous

#### Description

Step	Description
1.	Tap <b>Settings</b> .
2.	Tap <b>Miscellaneous</b> .

#### Miscellaneous

Field	Description
<b>Immediate keyboard</b>	When activated, the virtual keyboard appears when you click activating an input field. When deactivated, to see the keyboard, it is necessary to click in an input field and then to click again on the same field.
<b>Meteo info</b>	Activating this option the software queries periodically the server to have updated info about the weather.
<b>X-PAD Tips &amp; Tricks</b>	Reset the messages for trips and tricks that appear the very first time a command is selected.

#### Localisation settings

Field	Description
<b>Language</b>	Language used by the software. For a correct operation, it is necessary to restart the software after modifying the language.
<b>Localization package</b>	Allows installing the localisation packages available for the different countries.
<b>Time format</b>	Allows you to set the format <b>24 h</b> or <b>AM/PM</b> .
<b>Data format</b>	Allows you to set the date format.

## 5.10

### Automatic Export

#### Description

Step	Description
1.	Tap <b>Settings</b> .
2.	Tap <b>Automatic export</b> .



Field	Description
<b>Format</b>	Allows to set the format types of data to export automatic when closing the job. Enabling this option the software generates the requested formats automatically every time the job is closed avoiding this has to be done by the operator.

## 5.11

### Voice Commands

#### Description

The tab allows to set the vocal commands to execute the operations to management the surveying, stakeout, and handling of TPS and GNSS.

It is possible to customise the commands by entering the preferred word to start the action. To improve the command recognition reliability, run a self-learning procedure that consists of repeating the command 10 times.

Step	Description
1.	Tap <b>Settings</b> .
2.	Tap <b>Voice commands</b> .

#### Restore default commands

Step	Description
1.	Click  .
2.	Tap <b>Load default voice command</b> .

#### Android settings

To use voice commands, you must set the system language correctly in the device settings in the voice recognition menu. Recognition is faster when used in Off-line mode.

## 5.12

### Commands Manager

#### Description

The tab allows to show or hide every command of the menus of the software.

This avoids the accidental modification of settings and parameters by inexperienced operators.

After setting which commands have to be available, a password is requested. To edit the settings, the same password must be entered.

Step	Description
1.	Tap <b>Settings</b> .
2.	Tap <b>Commands manager</b> .

## 5.13

### X-Do!

#### Description

X-Do! (<https://flic.io/>) is a physical accessory that can be purchased and used in combination with X-PAD ULTIMATE. X-Do! pairs to the controller through Bluetooth and that can be used to start performing some operations.

The available actions are:

- Click
- Double-click
- Hold

It is possible to assign to each action a specific command of management of the GNSS and TPS survey and stakeout with GNSS and TPS.

**Description**

The tab allows to set a text and an image (logo) that appear in the heading of every generated report.

Step	Description
1.	Tap <b>Settings</b> .
2.	Tap <b>Report</b> .
3.	<p><b>Options</b></p> <ul style="list-style-type: none"> <li>• <b>Report type</b> Select: <ul style="list-style-type: none"> <li>• <b>ASCII format</b></li> <li>• <b>Excel CSV</b></li> <li>• <b>Excel XML</b></li> <li>• <b>PDF document</b></li> <li>• <b>HTML format</b></li> </ul> </li> <li>• <b>Stakeout differences</b> Define how stakeout differences are reported.</li> <li>• <b>Export by date range</b> Define if only data between certain dates are exported. Define the range.</li> </ul> <p><b>Sections</b> Select which data appear in the report:</p> <ul style="list-style-type: none"> <li>• <b>Coordinate system</b></li> <li>• <b>Points</b></li> <li>• <b>Reference points</b></li> <li>• <b>TPS measurements</b> Including TPS coefficients and parameters, TPS orientation (backsight, free station, ...), TPS calculation</li> <li>• <b>GNSS measurements</b> Including GNSS calculation</li> <li>• <b>COGO reference line</b></li> <li>• <b>Stakeout points</b> Including single points, objects, distances and offsets, surfaces, roads and sideslopes</li> </ul>
4.	Tap <input checked="" type="checkbox"/> <b>Accept</b> .

## 6

# Points, Measurements, Survey Codes and GIS Features Management

### Description

This set of commands provides access to lists of data present in the job:

- Topographic points
- Reference points of the site measurements
- Survey codes

### 6.1

## Topographic Points

### Description

Topographic points are all positions characterised by a name and having specific extra features.

Topographic points can come from:

- Direct measurement
- Manual input
- Importing of external files

A table shows the list of all topographic points present in the job. Points are listed according to inserting order, so at first place you find the last point inserted. An icon represents the origin of the point, the name, the code and the coordinates. Select a point for specific operations.

Step	Description
1.	Tap <b>JOB</b> .
2.	Tap <b>Points/Measurement/Codes</b> .
3.	Tap <b>Points</b> page.

### Creating a point step-by-step

Step	Description
1.	Click  .

The data of the point is organised in pages.







#### Coordinates page

Field	Description
<b>Point</b>	Name of the point
<b>E, N, Z</b>	Plane coordinates of the point
<b>Geodetic coords</b>	Allows entering the geographic coordinates of the point by choosing between: <ul style="list-style-type: none"><li>• Latitude, longitude and height</li><li>• Earth centred XYZ coordinates</li></ul>
<b>Lat., Long., Elevation:</b>	Geographic coordinates of the point

#### Properties page

Field	Description
<b>Code</b>	Survey code of the point The icon allows to access the codes library and to select a code from the list.
<b>Description</b>	Extended description of the point.
<b>Date</b>	Date and time of storing the point.
<b>GIS Data</b>	If the GIS module is activated and one or more codes with GIS information has been associated to the point, the <b>Edit</b> button can be used to insert and modify the corresponding GIS properties.

### Sketch page

Button	Description
	Deletes sketch and photo.
	Restores original content
	Adds a label with main information of the point. The label can be moved in every position.
	Adds a label with a free text. The label can be moved in every position.
	Adds an arrow symbol. The arrow can be moved and turned.
	Enables the free drawing mode.
	Starts the application allowing to shoot a photo and save it.

### AVERAGE page

If a point was measured several times and if the option **Average coords** is activated in the survey setup, it appears also the **AVERAGE** page.

The page reports the different measurements used for the coordinates calculation of the point. For every measurement, the differences referring to the average value are visualised. It is possible to decide which measurement to use for the calculation and also to edit directly a measurement.

#### Editing a point step-by-step

Step	Description
1.	Select a point from the table.
2.	Select <b>Edit</b> from the appearing menu.
3.	The content of the window is the same as for the creation of a point. Refer to <a href="#">Creating a point step-by-step</a> .

#### Deleting a point step-by-step

Step	Description
1.	Select a point from the table.
2.	Select <b>Delete</b> from the appearing menu.

#### Visualising point on CAD step-by-step

Step	Description
1.	Select point on table.
2.	Select <b>Display on CAD</b> from the appearing menu.
3.	The point is visualised in the centrr of the graphic window.

### Stakeout of a point step-by-step

Step	Description
1.	Select point on table.
2.	Select <b>Stakeout</b> from the appearing menu.
3.	The stakeout procedure starts. Refer to <a href="#">14 GPS - Stakeout</a> for further information.

### Sharing data of a point step-by-step

Step	Description
1.	Select point on table.
2.	Select <b>Share</b> from the appearing menu.
3.	Chose the sharing method and complete the procedure. For the selected point, the information related to coordinates (geographic and plane), code, description and eventually the photo/sketch associated is sent.

### Creating selection rules for points step-by-step



Define a rule that automatically selects all matching points.

Examples:

- Select all points starting with a certain letter.
- Select all points with a certain survey code.
- Select a set of points by name.
- Select a set of points by date.

Applications:

- Exporting to an ASCII file
- Creating surfaces
- Defining the stakeout list

Step	Description
1.	Select point on table.
2.	Tap  .
3.	Select <b>Edit</b> .
4.	Select one of the choices.
5.	Tap  .
6.	Select <b>Selection rule</b> .
7.	Define: <ul style="list-style-type: none"><li>• <b>Attribute</b> Selection on which feature the rule is based on.<ul style="list-style-type: none"><li>• <b>Name</b></li><li>• <b>Code</b></li><li>• <b>Layer</b></li><li>• <b>Type</b></li><li>• <b>Creation date</b></li><li>• <b>Elevation:</b></li></ul></li><li>• <b>Rule</b><ul style="list-style-type: none"><li>• <b>?</b> Indicates zero or one character. For example, "a?c" matches both "ac" and "abc", but not "abbc".</li><li>• <b>*</b> Indicates zero or more characters. For example, a*c matches "ac", "abc", "abbc", and so on.</li><li>• <b>+</b> Indicates one or more characters. For example, a+c matches "abc", "abbc", "abbbc" and so on but not "ac".</li></ul></li><li>• <b>Interval</b> The selection interval depends on the selected rule.</li></ul>

## Searching a point

Step	Description
1.	Tap  .
2.	Tap <b>Find point.</b>
3.	Enter the name of the point to search. If the point is found, it is put first in the table.

## Visualising latitude, longitude and elevation

Step	Description
1.	Tap  .
2.	Tap <b>View LLH.</b>
3.	Every point is displayed with geodetic coordinates, if available.

  

 117	L	N 45°57'09.2289"
	L	E 12°29'39.6190"
	H	52.727m

## Visualising East/X, North/Y and Elevation/Z

Step	Description
1.	Tap  .
2.	Tap <b>View ENZ.</b>
3.	Every point is displayed with plane coordinates., if available.



  

 117	E	234188.135m
	N	78465.442m
	H	-64.167m

## Visualising distance and direction

Step	Description
1.	Tap  .
2.	Tap <b>View Distance &amp; Direction.</b>
3.	Every point is displayed with the distance and direction from the current position. For the calculation, the software can use the GPS receiver connected or the GPS inside the TPS.

  

 117	4m	
---	----	---

## Setting elevation to points

Step	Description
1.	Tap  .
2.	Tap <b>Edit.</b>
3.	Tap <b>Set elevation to points.</b>
4.	Set a value for the elevation of the selected point.

### Adding elevation to points

Step	Description
1.	Tap  .
2.	Tap <b>Edit</b> .
3.	Tap <b>Add elevation to points</b> .
4.	Add a value for the elevation of the selected point.



### Inverting coordinates

Step	Description
1.	Tap  .
2.	Tap <b>Edit</b> .
3.	Tap <b>Invert coordinates</b> .
4.	Reverse the sign for the coordinates of all points. Press one of the keys. <ul style="list-style-type: none"><li>• <b>Invert coordinates</b> Activate the inversion for the East coordinates.</li><li>• <b>Invert coordinates</b> Activate the inversion for the North coordinates.</li></ul>

### Resetting the stakeout state

Step	Description
1.	Tap  .
2.	Tap <b>Edit</b> .
3.	Tap <b>Reset Stakeout state</b> .
4.	The software saves the staked points with the status of already staked out, in this way it is no longer possible to stakeout them. The command is used to delete this status in order to run the staking again.

### Deleting a group of points

Step	Description
1.	Tap  .
2.	Tap <b>Delete</b> .
3.	Tap <b>Topographic Points</b> .
4.	Select points to delete. Click  to select or deselect all points of the list.
5.	Click  to proceed with deleting of points.



### Deleting coincident points

Step	Description
1.	Tap  .
2.	Tap <b>Delete</b> .
3.	Tap <b>Delete coincident points</b> .
4.	Searches for points on the same position of another point and deletes the points.



### Diagram of distances and elevation

Step	Description
1.	Tap  .
2.	Tap <b>Diagram distance/elevation</b> .
3.	Points are displayed on a diagram with the distances on the horizontal axis and the elevation on the ordinate axis.



### Copying or moving selected points to the reference points table

Step	Description
1.	Tap  .
2.	Tap <b>Save/Load</b> .
3.	Tap <b>Transfer points to reference points</b> .
4.	Select points to copy or move. Click  to select or deselect all points of the list.
5.	Tap  .
6.	Select <b>Copy</b> or <b>Move</b> .

### Importing points from another job

Step	Description
1.	Tap  .
2.	Tap <b>Save/Load</b> .
3.	Tap <b>Load points from job</b> .
4.	Select the job from which to load points.
5.	Select the points to load. In the <b>Map</b> page, visualise the points on Google Maps. Click  to select or deselect all points of the list.
6.	Tap  to proceed with importing procedure.

### Exporting selected points on another job

Step	Description
1.	Tap  .
2.	Tap <b>Save/Load</b> .
3.	Tap <b>Save points to job</b> .
4.	Select points to save. Click  to select or deselect all points of the list.
5.	Click  .
6.	Select the job to which the selected points must be exported.

### Changing the visualisation order

Step	Description
1.	Tap  .
2.	Tap <b>Sort</b> .
3.	Sorting options: <ul style="list-style-type: none"><li>• Ascending or descending order of the point nam</li><li>• Name of the points</li><li>• Creation date</li><li>• Ascending or descending order of the code name</li></ul>



## 6.2

## Fieldbook of Measurements

### Description

The fieldbook of measurements reports the chronological list of all measurements performed on site.

The measurements are listed according to measurement order. The last measurement is on top of the list.



For every measurement, an icon specifying the type of measurement, the name of the measured point, the date and time of acquisition, the code, description and other information is displayed.

Step	Description
1.	Tap <b>JOB</b> .
2.	Tap <b>Points/Measurement/Codes</b> .
3.	Tap <b>Measure</b> page.

### Editing a measurement step-by-step

Step	Description
1.	Select a measurement on the table.
2.	Select <b>Edit</b> from the appearing menu.
3.	The data of the measurements are displayed on different pages. Only some of them are editable.

### Points page

Field	Description
<b>Points</b>	Name of the point
<b>Rover Antenna height</b>	Antenna elevation (GPS)  When the antenna elevation is changed, the corresponding point coordinates are recalculated.
<b>Target height</b>	Target elevation (TPS)  When the target elevation is changed, the corresponding point coordinates are recalculated.

### Code page

Field	Description
<b>Code</b>	Code of the point
<b>Description</b>	Extended description of the point
<b>GIS Data</b>	Allows to edit the GIS attribute.

### Sketch page

Field	Description
<b>Sketch</b>	Sketch or picture associated with the point

### Change target or pole height step-by-step



Step	Description
1.	Select a measurement on the table.
2.	Define if the change applies to one or to all session measurements.
3.	Enter the value to assign for the target or pole height.
4.	Click <input checked="" type="checkbox"/> .
	When the target or pole height is changed, the corresponding point coordinates are recalculated.

## Deleting and restoring measurements step-by-step



### Deleting

Step	Description
1.	Select a measurement on the table.
2.	Select <b>Delete</b> .
	The measurement is not completely deleted but the delete status is assigned. The measurement can be restored at any time.

### Restoring

Step	Description
1.	Select <b>JOB</b> .
2.	Select <b>Points/Measurement/Codes</b> .
3.	Select <b>Measurements</b> page.
	Select a measurement on the table which has the delete status is assigned y the  icon.
4.	Click <b>Restore</b> .

### Deleting a group of measurement

Step	Description
1.	Select <b>JOB</b> .
2.	Select <b>Points/Measurement/Codes</b> .
3.	Select <b>Measurements</b> page.
4.	Tap  .
5.	Select <b>Delete measurements</b> .
6.	Select a measurement on the table. Click  to select or deselect all measurements of the list.
7.	Click  to proceed with deleting of measurements.

## Searching for a measurement step-by-step

Step	Description
1.	Tap  .
2.	Select <b>Find measure</b> .
3.	Enter the name of the point to search. If a point with a corresponding name is found, it is placed first in the list.

## Notes step-by-step

From the list of measurements, notes can be displayed, hidden or added.

Two types of notes are available:

Type	Description
Automatic notes	Notes inserted automatically by the software in response to certain events. For example: <ul style="list-style-type: none"> <li>• Connection of the instrument</li> <li>• Interruption of the connection to the instrument</li> <li>• Start of the base</li> <li>• Start of raw data recording</li> <li>• Interruption of raw data recording</li> </ul>
User notes	Texts, sketches and photo saved by the user

### Displaying or hiding notes

Step	Description
1.	Tap  .
2.	Select <b>View Notes</b> or <b>Hide Notes</b> .

### Adding a note

Step	Description
1.	Tap  .
2.	Add a descriptive text on the first page.
3.	Add a sketch or a photo. on the second page.

### Moving the GNSS base step-by-step

After post-processing the raw data from the base and obtaining corrected coordinates for the base, the coordinates of the base can be changed. The coordinates of all other points in the job are updated.

Step	Description
1.	Tap  .
2.	Select <b>Edit</b> .
3.	Select <b>Shift GNSS base</b> .
4.	Decide between adding new coordinates and shifting the existing values.
5.	Confirm that the coordinates of the base are changed and that the coordinates of all measured points updated.

Field	Description
<b>Base name</b>	List of base points present in the job. Select the base for which to insert the new coordinates.
<b>Mode</b>	Decide between adding new coordinates and shifting the existing values. <ul style="list-style-type: none"><li>• <b>New coordinates LLH</b> To insert new values for longitude, latitude and height.</li><li>• <b>Shifting values LLH</b> To insert values for shifting in longitude, latitude and height.</li><li>• <b>New coordinates ENZ</b> To insert new values for East, North and elevation.</li><li>• <b>Shifting values ENZ</b> To insert values for shifting in East, North and elevation.</li></ul>
<b>Latitude, Longitude, Height E, N, Z</b>	Insert the new coordinates of the base or of the movement values.

### Report of measurements step-by-step

Generates a detailed report of all measurements in the job.

Available output formats:

- ASCII
- CSV for Excel
- XML for Excel
- PDF
- HTML

Step	Description
1.	Tap  .
2.	Select <b>Measurements report</b> .

## Create surface from bathymetry step-by-step

To create a three-dimensional triangle surface using the points of bathymetric sessions.

Step	Description
1.	Tap  .
2.	Select <b>Create surface from bathymetry</b> .
3.	Select the bathymetric sessions and proceed with creation of the surface.

Field	Description
<b>Name</b>	Name of surface to create
<b>Contour lines</b>	Enables visualisation of the contour lines on the surface.
<b>Contour step</b>	Equidistance used to draw the curves.
<b>Contour color</b>	Colour to use to draw the curves.

## 6.3

### Reference Points

#### Description

The table of reference points manages all topographic points with known coordinates which can be used in different situations as reference points and check points.

Step	Description
1.	Tap <b>JOB</b> .
2.	Tap <b>Points/Measurement/Codes</b> .
3.	Tap <b>Reference</b> .
4.	The functionality of the table is similar to the <b>Points</b> table. Refer to <a href="#">6.1 Topographic Points</a> .

## 6.4

### Survey Codes

#### Description

Survey codes allow the precise identification of points and to automate many operations to complete a drawing of the survey.

For every code, information can be added:

- A description
  - A symbol and layer
  - A GIS feature
- Based on the code, points are represented with a certain symbol and on a certain layer. The GIS feature is composed by a group of properties freely definable by the user. When a code or a GIS feature is associated to a point it is possible to integrate the point with the information corresponding to properties defined by the feature.

Survey codes can be defined in a parametric way that generate a corresponding parametric long description.

Different libraries of codes can be defined and used in different jobs. The current library can be exchanged with a different one.

Step	Description
1.	Tap <b>JOB</b> .
2.	Tap <b>Points/Measurement/Codes</b> .
3.	Tap <b>Codes</b> . Listed are all survey codes of the current library. For every code, a symbol and a description are displayed.



Code libraries are saved as files in the directory X-PAD\\_Data\Codes. Files have \*.xml extension.

## Creating a code step-by-step

Step	Description
1.	Click 

The data of the code is organised in pages.

### Main data page

Field	Description
<b>Code</b>	Name of the code For a parametric codes define for example: <ul style="list-style-type: none"> <li>• D#</li> <li>• D25</li> <li>• LP.D25 (usage with multiple codes)</li> </ul>
<b>Description</b>	Extended description For a parametric codes define for example: <ul style="list-style-type: none"> <li>• Distance # cm from measured point</li> <li>• Distance 25 cm from measured point</li> <li>• Lamp post distance 25 cm from measured point</li> </ul>
<b>Layer</b>	Layer associated to point
<b>Color by layer</b>	The colour of the layer is used for the drawing of the point symbol
<b>Color</b>	Colour used for the point symbol if the layer colour is not used
<b>Symbol size</b>	Dimension of the symbol
<b>Drawing type</b>	Defines how the measured object is shown in graphics. <ul style="list-style-type: none"> <li>• <b>Single point</b> A single position is used, for example for a tree or an illumination pole.</li> <li>• <b>Line</b> A polyline is used, for example for the side of a road or a wall.</li> <li>• <b>Square diagonal</b> A square is used inserted at the opposite end of the measured point.</li> <li>• <b>Square Center</b> A square is used inserted at the centre of the measured object or in the middle of a measured line.</li> <li>• <b>Rectangle base</b> A rectangle is used inserted at the opposite end of the measured point of the base and a point on the opposite side</li> <li>• <b>Rectangle center</b> A rectangle is used inserted at the centre, the middle point on a side and a third point on the other side</li> <li>• <b>Circle 3P</b> A circle is used inserted by measuring three points on the circumference.</li> <li>• <b>Circle center</b> A circle is used inserted by measuring the center point and a point on the circumference.</li> <li>• <b>Spline</b> A spline is used.</li> <li>• <b>Control point</b> A control point measurement is used.</li> </ul>
<b>GIS features</b>	One of the GIS features from the current job can be assigned to the point. More information can be added defined by the properties of the associated GIS feature.

### Layer & Color page

These are the settings for the single layer. When creating a layer, the default settings saved in the main **Settings** page are displayed. The settings here can be changed

Field	Description
<b>Layer</b>	Layer linked to point
<b>Color by layer</b>	The colour of the layer is used for the drawing of the point symbol
<b>Color</b>	Colour used for the point symbol if the layer colour is not used
<b>Symbol size</b>	Dimension of the symbol

### Symbol page

Field	Description
Symbol	Select a symbol used to draw the point to which the code is associated. Click  .

### Editing a code step-by-step



Step	Description
1.	Select a code from the table.
2.	Select <b>Edit</b> from the appearing menu.
3.	The content of the window is the same as for the creation of a code. Refer to <a href="#">Creating a code step-by-step</a> .

### Deleting a code step-by-step

Step	Description
1.	Select a code from the table.
2.	Select <b>Delete</b> from the appearing menu.

### Tools of the Codes page

#### Deleting a group of codes

Step	Description
1.	Tap  .
2.	Tap <b>Delete codes</b> .
3.	Select codes to delete. Click  to select or deselect all codes of the list.
4.	Click  to proceed with deleting of codes.

#### Creating a library





Step	Description
1.	Tap  .
2.	Tap <b>New library</b> .
3.	Enter a name for the library. The new table is empty and ready to insert new codes.

#### Loading a library

Step	Description
1.	Tap  .
2.	Tap <b>Load library</b> .
3.	Tap <b>Load library</b> .
4.	Select the file corresponding to library to load.

#### Importing a code list from ASCII file

Step	Description
1.	Tap  .
2.	Tap <b>Load library</b> .
3.	Tap <b>Load library from text file (ASCII)</b> .
4.	Select text file to load.

Step	Description
5.	Select the importing scheme or select <b>Custom</b> to create an import scheme.
6.	For <b>Custom</b> : Set the separation character.
7.	Set the number of lines composing the header of the file and that have hence not to be imported.
8.	Tap  .
9.	For <b>Custom</b> : Decide which fields are present in the file and in which order.
10.	Tap  .
11.	A preview of the importing result is displayed.
12.	Tap  .
13.	For <b>Custom</b> : Assign a name to the importing scheme so that it can be reused.
14.	Tap  to start the import.



Schemes for import and export are saved as files in the directory X-PAD\Data\Schemes. Files have \*.psc extension.

#### Importing codes list from a GeoMapper file

Step	Description
1.	Tap  .
2.	Tap <b>Load library</b> .
3.	Tap <b>Load library from GeoMapper file</b> .
4.	Select the GeoMapper file containing the codes to import.

#### Importing a code list from SCC file (Microsoft Visual SourceSafe)

Step	Description
1.	Tap  .
2.	Tap <b>Load library</b> .
3.	Tap <b>Load library from SCC file</b> .
4.	Select the SCC file containing the codes to import.

#### Importing a code list from LandXML file

Step	Description
1.	Tap  .
2.	Tap <b>Load library</b> .
3.	Tap <b>Load library from LandXML</b> .
4.	Select either to add codes to the current library or to create a new library.
5.	Select the LandXML file containing the codes to import.

#### Exporting the current library

Step	Description
1.	Tap  .
2.	Tap <b>Save a library copy</b> .
3.	Assign a name used to save the current library.

### Exporting the current code library as default code library

Step	Description
1.	Tap  .
2.	Tap <b>Save library as default.</b>
3.	The current code library is saved as default. Every new job uses this code library automatically.

### Managing GIS data

Step	Description
1.	Tap  .
2.	Tap <b>GIS Manager.</b>
3.	The table of GIS features that can be added to survey codes is displayed.

### Symbols manager step-by-step

In the **Symbols manager**, symbols for points codes can be added or deleted.

Step	Description
1.	Tap <b>JOB.</b>
2.	Tap <b>Points/Measurement/Codes.</b>
3.	Tap <b>Codes</b> page.
4.	Tap <b>New code</b> or <b>Modify code.</b>
5.	Tap <b>Symbol</b> page.
6.	Click  .

### Deleting a symbol

Step	Description
1.	Select a symbol from the table.
2.	Select <b>Delete</b> from the appearing menu.

### Importing symbols

Symbols can be imported from blocks of DXF files.

 Blocks to use to become symbols must have the base entities like lines, polylines, arcs and circles and must have small dimension.

Step	Description
1.	Tap  .
2.	Tap <b>Import blocks from DXF.</b>
3.	Select the DXF file having blocks to import. For every block in the DXF file, the maximum dimension and a corresponding scale factor for the symbol is calculated.

 Reference blocks can be used as snap point to create topographic points, to create drawings or as coordinate to stakeout.

## 6.5

### GIS Features

#### Description

A GIS feature consists of a group of properties which describe elements of the measured area.

The GIS features are used to measure and describe elements of the measured area with the scope to create a GIS system.



### Example of GIS features

GIS feature	Attribute name	Attribute type	Constraints
Well	Type	List of values	
	Depth	Floating-point value	Obligatory
	Number of connections	Integer value	Minimum 1 Maximum 4
	Maintenance	True/False	
Tree	Type	List of values	
	Elevation	Floating-point value	Obligatory
	Diameter	Floating-point value	Obligatory
	To cut	True/False	

The library of GIS features with the corresponding attributes is user-definable.



Every GIS feature can be associated to a survey code.

### During a survey

- Saving a point  
The software checks the survey code associated with the point. If a GIS feature is associated to the survey code, a window is displayed allowing to add the corresponding attributes.
- Saving a line  
The attributes can be assigned to the first point of the line, to all points or to the last point of the line. In most cases, the last point of the line is the best solution because more information about the line is available.

### Export



All information associated to points can be exported in different ways.

Step	Description
1.	Tap <b>JOB</b> .
2.	Tap <b>Points/Measurements/Codes</b> .
3.	Tap <b>Code</b> page.
4.	Tap  .
5.	Tap <b>GIS Manager</b> .
6.	The total number of GIS features is displayed at the bottom left. Tap  to sort the features by name to simplify the search and the editing.

### Creating a GIS feature step-by-step

Step	Description
1.	Click  .

Field	Description
<b>Name</b>	Name of the GIS feature
<b>Attributes</b>	List of attributes defined by the feature Define specific attributes. OR Select from predefined attributes. The value of predefined attributes is extracted from the measurement. Examples for predefined attributes: <ul style="list-style-type: none"> <li>• <b>Point Date</b></li> <li>• <b>Point Time</b></li> <li>• <b>GNSS Horizontal accuracy</b></li> <li>• <b>GNSS Vertical accuracy</b></li> <li>• <b>Cable detector depth</b></li> </ul>

Button	Description
	To create an attribute.
	To move the attribute to the previous position.
	To move the attribute to the next position.

#### Editing a GIS feature step-by-step

Step	Description
1.	Select a GIS feature from the table.
2.	Select <b>Edit</b> from the appearing menu.
3.	The content of the window is the same as for the creation of a GIS feature. Refer to <a href="#">Creating a GIS feature step-by-step</a> .

#### Deleting a GIS feature step-by-step

Step	Description
1.	Select a GIS feature from the table.
2.	Select <b>Delete</b> from the appearing menu.

#### Adding a GIS feature step-by-step

Step	Description
1.	Click  .

Field	Description
<b>Name</b>	Name of the attribute
<b>Type</b>	Value of the attribute <ul style="list-style-type: none"> <li><b>Text</b> Alpha-numeric text</li> <li><b>Integer number</b> Any number, positive or negative, without fraction, including 0. Examples: 1, 108, -43</li> <li><b>Real number</b> Any number, positive or negative, with fraction, without 0. Examples: 1.5, 108.46, -43.98</li> <li><b>Title</b> The title is not an attribute but the title of the group of the following attributes</li> </ul>
<b>Prompt</b>	Text requesting the attribute
<b>Default value</b>	Value to purpose as default
<b>List</b>	List of values
<b>Fixed list</b>	When activated, the value of the attribute must be selected from the list of values and can not be entered manually
<b>Mode</b>	Mode of request of value <ul style="list-style-type: none"> <li><b>Active</b> Normal request</li> <li><b>Read only</b> The attribute is not editable.</li> <li><b>Hidden</b> The attribute is hidden and is not visible.</li> </ul>
<b>Obligatory</b>	When activated, a value for the attribute must be assigned. It cannot be left without a value.

**Tools of the GIS features page**

**Saving GIS features**

Step	Description
1.	Tap  .
2.	Tap <b>Save GIS features.</b>
3.	Assign a name used to save the current library. Exports the GIS features of the current job to an external library. It can then be used in other jobs.

**Loading GIS features**

Step	Description
1.	Tap  .
2.	Tap <b>Load GIS features.</b>
3.	A library of GIS features previously exported from another job is loaded in the current job.

**Description**

The coordinate system allows the definition of parameters and methods for the calculation including for the transformation of the geographic coordinates obtained from GPS instruments.



Modification of the coordinate systems parameters causes an automatic recalculation of the coordinates of the GPS points in a job. This way the coordinate system can be changed at any time.

**Tools of the Coordinate System page**

Step	Description
1.	Tap <b>JOB</b> .
2.	Tap <b>Coordinate System</b> .
3.	Tap

**Loading a coordinate system**

A coordinate system previously saved from another job can be loaded and used in the current job.

Step	Description
1.	Tap .
2.	Tap <b>Load system</b> .
3.	Select a file of the coordinate system to load.

**Saving the current coordinate system**

Step	Description
1.	Tap .
2.	Tap <b>Save current system</b> .
3.	Define the name for the file and the folder where to save.
4.	The parameters and settings of a coordinate system are saved in an external file to be used in other jobs relate to the same zone.



Files containing the definition of a coordinate system have \*.psc extension.

**Saving a coordinate system as default**

Step	Description
1.	Tap .
2.	Tap <b>Save as default system</b> .
3.	The parameters and settings of a coordinate system are saved as default. Every new job uses the coordinate system automatically.

**Saving a coordinate system as site default**

Step	Description
1.	Tap .
2.	Tap <b>Save as site default system</b> .
3.	The parameters and settings of a coordinate system are exported as site default system. The coordinate system is applied to all new jobs of a site by default

**Report of the current coordinate system**

Generates a detailed report of all settings of the current coordinates system.

Available output formats:

- ASCII
- CSV for Excel
- XML for Excel
- PDF
- HTML

Step	Description
1.	Tap  .
2.	Select <b>Report</b> .

### Share to X-PAD 365

Share the selected coordinate system directly in the X-PAD 365 chat.

Step	Description
1.	Tap  .
2.	Select <b>Share to X-PAD 365</b> .

## 7.1

### Cartographic System

#### Description

Setting the cartographic system is necessary when coordinates of points must refer to a system defined by a reference projection, datum, ellipsoid and transformation parameters.

The cartographic system can be used for:

- The calculation of geographic coordinates of GPS instruments
- The calculation of the scale factor to apply to distances measured with total stations

Select a predefined system or define a system with specific parameters.

Step	Description
1.	Tap <b>JOB</b> .
2.	Tap <b>Coordinate System</b> .
3.	Tap <b>Cartographic system</b> page.

Field	Description
<b>Name</b>	Name to assign to the system
<b>Projection</b>	Cartographic projection to use
<b>Datum</b>	Datum to use to convert from the WGS84 ellipsoid to the cartographic system ellipsoid. Click the field to access a list of default and user-defined datum.
<b>Ellipsoid</b>	Ellipsoid of the cartographic system. Click the field to access a list of default and user-defined ellipsoids.
<b>Origin Lat</b> <b>Origin Lon.</b> <b>False East</b> <b>False North</b> <b>Scale</b>	Parameters of the coordinate system



If the cartographic system should be used for the transformation of the GPS coordinates, it must be specified using the command **GNSS Localization**.

#### Tools of the Cartographic system page

#### Saving a system as predefined

Step	Description
1.	Tap  .
2.	Tap <b>Save as predefined</b> .

Step	Description
3.	Save the current system in the <b>User</b> group of the predefined systems. The system can then be used in other jobs.

### Loading a predefined system

Step	Description
1.	Tap  .
2.	Tap <b>Load predefined system</b> .
3.	Per default, a wide list of coordinate systems used in different countries is available. They are organised by country. Or select a user-defined system from the <b>User</b> group.

### Deleting the current cartographic system

Step	Description
1.	Tap  .
2.	Tap <b>Cancel current cartographic system</b> .

## 7.2



### GNSS Localisation

#### Description

Define the method to use for transformation of the GPS coordinates in plane coordinates and vice versa.



Without an assigned GPS localisation, only the geographic coordinates of the points are recorded. A visualisation of the points in the graphic window is impossible.

Step	Description
1.	Tap <b>JOB</b> .
2.	Tap <b>Coordinate System</b> .
3.	Tap <b>GNSS Localization</b> .



System	Description
<b>No system</b>	No coordinate system is applied
<b>Local - Single point</b>	A system is created based on a local projection referred to one origin point.
<b>Local - Site calibration</b>	A system is created based on several points with known geographic and local plane coordinates.
<b>Reference axis</b>	A system is created based on the measurement of a point of origin and the measurement of a second point which defines the direction of the axis. Refer to <a href="#">Reference axis</a> . Available for  .
<b>2 Reference axis</b>	The position and orientation of the station are determined by measuring four reference points. The points define two axes which, intersecting each other, determine the position of the station. Available for  .
<b>Cartographic system</b>	For the transformation from geographic to plane coordinates a cartographic system is used. Refer to <a href="#">7.1 Cartographic System</a> for an explanation of cartographic systems.

#### Local system – single point

Step	Description
1.	Select <b>Local - Single point</b> .
2.	Tap <b>Details</b> .

Step	Description
3.	Specify the geographic coordinates of the reference point. <ul style="list-style-type: none"> <li>Select an existing point from the job by typing the name, selecting it from the graphic or selecting it from a table.</li> <li>Measure a point. Tap <b>Measure</b>. In a window, specify the elevation of the antenna.</li> </ul>
4.	Tap  .
5.	Specify the local coordinates of the reference point. <ul style="list-style-type: none"> <li>Select an existing point from the job by typing the name, selecting it from the graphic or selecting it from a table.</li> <li>Type in the local coordinates.</li> </ul>
6.	Tap  .
7.	Specify the mode for the calculation to use for elevations.

### Local system – site calibration

Step	Description															
1.	Select <b>Local - Site calibration</b> .															
2.	Tap <b>Details</b> .															
3.	In the table, pairs of points are listed which can be used for the calculation of the local system. For each pair, it can be defined if the data are used for the calculation of the plane transformation and for the elevation. Based on the selection, the method for the calculation of the plane coordinates is selected automatically. For each pair, the deviations regarding the coordinates and elevations are calculated. <div style="text-align: center; margin: 10px 0;"> <table style="border: none; margin: auto;"> <tr> <td style="font-size: 2em; vertical-align: middle;"><input checked="" type="checkbox"/></td> <td style="font-size: 1.5em; vertical-align: middle;">H 0.002m</td> <td style="font-size: 1.5em; vertical-align: middle;">1 - 100a</td> <td style="font-size: 1.5em; vertical-align: middle;">Lat.</td> <td style="font-size: 1.5em; vertical-align: middle;">N 45°17'11.3864"</td> </tr> <tr> <td style="font-size: 2em; vertical-align: middle;"><input checked="" type="checkbox"/></td> <td style="font-size: 1.5em; vertical-align: middle;">V 0.014m</td> <td style="font-size: 1.5em; vertical-align: middle;">H</td> <td style="font-size: 1.5em; vertical-align: middle;">Lng.</td> <td style="font-size: 1.5em; vertical-align: middle;">E 9°28'26.0826"</td> </tr> <tr> <td></td> <td></td> <td></td> <td style="font-size: 1.5em; vertical-align: middle;">H</td> <td style="font-size: 1.5em; vertical-align: middle;">118.047m</td> </tr> </table> </div>	<input checked="" type="checkbox"/>	H 0.002m	1 - 100a	Lat.	N 45°17'11.3864"	<input checked="" type="checkbox"/>	V 0.014m	H	Lng.	E 9°28'26.0826"				H	118.047m
<input checked="" type="checkbox"/>	H 0.002m	1 - 100a	Lat.	N 45°17'11.3864"												
<input checked="" type="checkbox"/>	V 0.014m	H	Lng.	E 9°28'26.0826"												
			H	118.047m												
4.	Tap  to add a pair of points.															
5.	Specify the geographic coordinates of the reference point. <ul style="list-style-type: none"> <li>Select an existing point from the job by typing the name, selecting it from the graphic or selecting it from a table.</li> <li>Measure a point. Tap <b>Measure</b>. In a window, specify the elevation of the antenna.</li> </ul>															
6.	Tap  .															
7.	Specify the local coordinates of the reference point in one of the following ways: <ul style="list-style-type: none"> <li>Select an existing point: <ul style="list-style-type: none"> <li>From the job by typing the name</li> <li>From a graphic</li> <li>From a table</li> </ul> </li> <li>Or add a point by typing in the local coordinates.</li> </ul>															
8.	Continue adding more points.															
9.	Verify deviations calculated for every point and the scale factor visualised in the lower part of the window. <div style="text-align: center; margin: 10px 0;"> <div style="background-color: #e0e0e0; padding: 20px; border: 1px solid #ccc;"> <p style="font-size: 1.5em; margin: 0;">Calculation completed.</p> <p style="font-size: 1.5em; margin: 0;">Scale factor: 1.0000</p> </div> </div>															
10.	Tap  .															
11.	Select the mode of calculation to use for elevations. In the lower part of the window, the method of calculation chosen by the software is displayed. The selection is based on the number of available localisation points.															

Step	Description
12.	Click on the panel to select the scale application mode.

Method	<b>Barycentric</b>	➤
Scale	<b>Conformal (scaled)</b>	

- **Rigid body (unscaled)**  
No scale factor is applied. The original distances between measured points are maintained.
- **Conformal (scaled)**  
A scale factor is calculated and applied.
- **Helmert 3D**  
Geometric transformation with 7-parameters within a three-dimensional space. A scale factor is calculated and applied.

### Tools of the GNSS Localization page

The **Tools** offers options for importing and compiling calibration points.

Step	Description
1.	Tap  .

System	Description
<b>Import from reference points</b>	Import of points which have both the cartographic coordinates (North, East, elevation) and geographic coordinates (latitude, longitude, height).
<b>Import FieldGenius RAW file</b>	Import of calibration systems defined in a job created with software FieldGenius. The RAW file of FieldGenius is required.
<b>Import SurvCE LOC file</b>	Import the calibration system from SurvCE program in LOC format.
<b>Export for Topcon Machine Control</b>	Export of the calibration system to Topcon Machine Control system.
<b>Export SurvCE LOC file</b>	Export of the calibration system for the SurvCE program in LOC format.
<b>Delete all points</b>	Delete all points of the calibration system.

### Reference axis



A system is created based on the measurement of a point of origin and the measurement of a second point which defines the direction of the axis.

Step	Description
1.	Select <b>Reference axis</b> .
2.	Tap <b>Details</b> .
3.	Enter the coordinates for the origin point of the reference axis.
4.	Tap <b>Measure</b> to measure a reference point. OR Tap <b>Select</b> to choose the coordinates from the CAD window.
5.	Tap <b>Measure</b> to measure the origin point of the reference axis.
6.	Tap <b>Measure</b> to measure a point that defines the direction of reference axis.
7.	Select the calculation method to be used for elevation.
8.	Tap <b>Accept</b> .
9.	Before selecting a cartographic system for use, related settings must be defined. Refer to <a href="#">7.1 Cartographic System</a> .
10.	Select <b>Cartographic system</b> .
11.	Tap <b>Details</b> .



Step	Description
12.	The parameters of the current cartographic system are displayed. In X-PAD for Windows Mobile, a cartographic system can be selected from the systems available.
13.	Tap  .
14.	After defining the mode of calculation of the coordinates the procedure allows to set the mode to use for elevation calculation. <ul style="list-style-type: none"> <li>• <b>WGS84 ellipsoid height</b> The elevation on the WGS84 ellipsoid is maintained.</li> <li>• <b>Reference ellipsoid height</b> When a cartographic system has been set: The elevation referred to the reference ellipsoid of the cartographic system is assigned.</li> <li>• <b>Elevation on local system</b> When a local system has been set: The elevation referred to a local system data is assigned.</li> <li>• <b>Reference elevation</b> The elevation is referenced to a control point that can be measured or selected from the points database.</li> <li>• <b>Geoid</b> The geoid models installed with the localisation packages are listed. The elevation is calculated by interpolation on the selected geoid model.</li> <li>• <b>Offset</b> To set a value to be added to the elevation calculated using one of the above methods.</li> </ul>

### Two reference axis

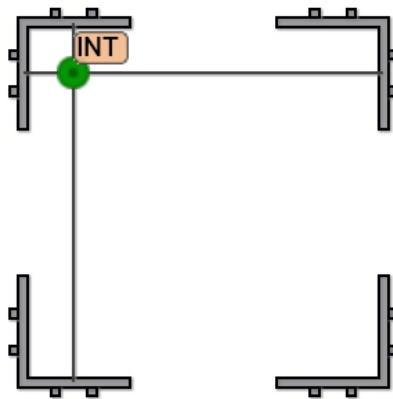

Step	Description
1.	Tap <b>Measure</b> to measure the two points, which define the first reference axis.
2.	Tap <b>Measure</b> to measure the two points, which define the second reference axis.
3.	Tap <b>Select</b> to choose the first reference line from the graphic window.
4.	Choose the second reference line from the graphic window.
5.	The two possible solutions for the position of the station are proposed.
6.	Click on the correct solution.
7.	Tap <b>Save</b> .
8.	The procedure ends with storing the position and orientation of the station.

## 7.3

### TPS Coefficients

#### Description

Define parameters for the reduction of the distances measured with the total station to the sea level and at the cartographic plane.

Step	Description
1.	Tap <b>JOB</b> .
2.	Tap <b>Coordinate System</b> .
3.	Tap <b>Ground to grid scale factor</b> .

Field	Description
<b>To sea level</b>	The reduction is calculated to the sea level based on the set average elevation.
<b>Average elevation</b>	The reduction is calculated to an average elevation of the distances.
<b>To cartographic plane (grid)</b>	The reduction is calculated to distances at the cartographic plane.
<b>Scale factor (global)</b>	<p>The reduction is calculated using a scale factor to the cartographic plane.</p> <ul style="list-style-type: none"> <li>• <b>None</b> The software does not apply a scale factor.</li> <li>• <b>Global scale factor</b> The scale factor can be inserted manually or calculated based on a coordinate. A cartographic system must be set. This factor is applied to all TPS measurements.</li> <li>• <b>Automatic scale factor</b> The scale factor is calculated for each TPS measurement using the average position between the measured point and the total station. A cartographic system must be set.</li> </ul>

## 7.4

### Base Position Adjustment

#### Description

Insert or calculate a correction factor for the base position so that the rover has exact coordinates.

Example:

Start the base on an unknown position. Then go with the rover to a point with known coordinates and measure it. The difference between the known position and the position provided by the base represent the correction in latitude, longitude and height that must be applied continuously to coordinates of the rover.

Step	Description
1.	Tap <b>JOB</b> .
2.	Tap <b>Coordinate System</b> .
3.	Tap <b>Base pos. adjustment</b> .
4.	Tap <b>Measure</b> to measure with the rover a point with known coordinates in the defined coordinates system.
5.	Define the local coordinates corresponding to the reference point. Select an existing point from the job by typing the name, selecting it from the graphic or selecting it from a table
6.	<p>The difference between the coordinates of the point provided by the base and the coordinates calculated from the known point is the difference which will be saved and applied to coordinates of the rover automatically.</p> <ul style="list-style-type: none"> <li>• <b><math>\Delta</math> Latitude, <math>\Delta</math> Longitude, <math>\Delta</math> Elevation</b> Correction in geographic coordinates to apply to coordinates received from the base to have the correct coordinates (as if the base were located on a known point).</li> </ul>

# 8

## CAD

### Description

CAD is a fundamental element in X-PAD allowing to use the software not only for survey and stakeout but also as a flexible tool helping in every situation.

### Access to CAD

Step	Description
1.	Tap  .
2.	The window has a tool bar in the lower part from which you access to all the CAD functions.

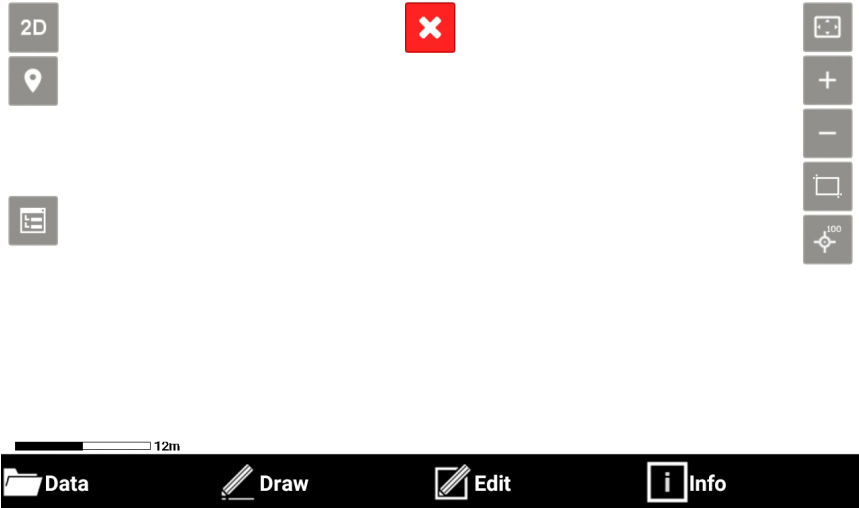

The screenshot shows a CAD interface. At the top, there are three icons: '2D', a location pin, and a project manager icon (a square with a grid). To the right, there is a vertical toolbar with icons for zoom in (+), zoom out (-), a square, and a 100% zoom icon. In the center, there is a red square with a white 'X' icon. At the bottom, there is a black navigation bar with four icons: 'Data' (a folder), 'Draw' (a pencil), 'Edit' (a pencil with a slash), and 'Info' (an 'i' in a square). Above the navigation bar, there is a scale bar showing 12m.



The Project Manager icon  appears only on tablets.

### Closing CAD

Step	Description
1.	Click in the area for graphic visualisation. An icon for closing the CAD window appears.
2.	Tap  .

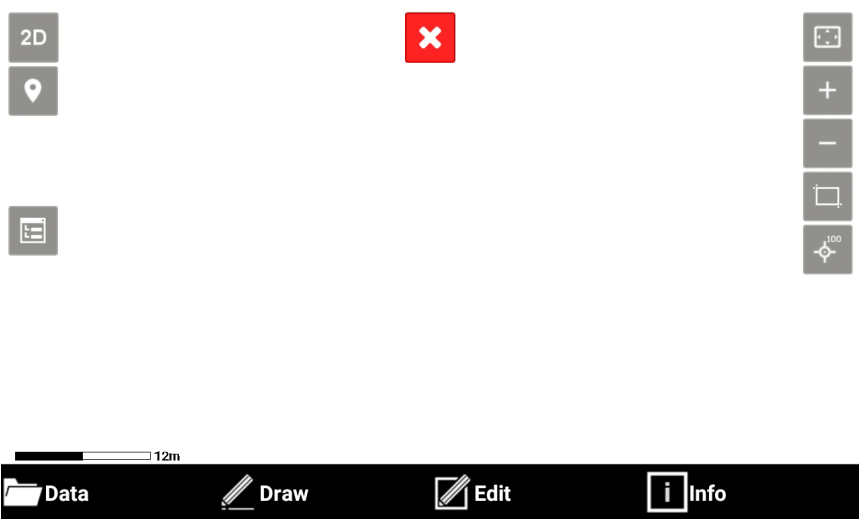

The screenshot shows the same CAD interface as above. The red square with a white 'X' icon is now larger and more prominent, indicating it is the focus of the instruction. The rest of the interface, including the toolbars and navigation bar, remains the same.

## 8.1







# Controlling the Visualisation

### Activating buttons and commands



Step	Description
1.	Click in the graphical windows of the drawing display. The buttons and commands for displaying the drawing are activated.

### Buttons and commands

#### Buttons

Button	Description
	<b>Zoom all</b> Displays of all the drawing elements
	<b>Zoom window</b> Allows to specify the visualization area through indication of the opposite angles
	<b>Zoom in</b> Enlarging the visualisation
	<b>Zoom out</b> Reducing the visualisation
	<b>Points labels</b> Enable and disable displaying point data
	<b>Points visibility</b> Enable and disable visibility of points
	<b>Working area</b> The icon notifies that the drawing extension is too large to display all elements appropriately and allows you to define the working area.

#### Commands

Button	Description
<b>Pan</b>	Shifting of the view is always active. Click in the graphic area and drag the view.
<b>Pinch out</b>	Tap in the graphic area using two fingers and spread them on the screen. 
<b>Pinch in</b>	Tap in the graphic area using two fingers and merge them on the screen. 



### Setting the working area step-by-step

When the drawing extension is too large to display all items correctly,  appears.  
By clicking on the icon, the area to work on can be defined.





When a working area is stored, the software uses it as default view for the **CAD** and **Job** window. If a working area is defined, the command **Zoom Max.** shows the defined working area.

Working areas can be defined in the two ways.



### Setting a working area directly

Step	Description
1.	Tap  .
2.	Perform the view adjustment. 
3.	Tap  to save the working area.

### Defining a working area

Step	Description
1.	Tap  .
2.	Click <b>Define working area.</b> Tap  . If you have already defined a working area, you can create a new one.
3.	Perform the view adjustment. 
4.	Tap  to save the working area.

### Erasing a working area

Step	Description
1.	Click <b>Remove working area.</b> Tap  .
2.	Click <b>Zoom Max.</b> to show the entire drawing area. Tap  .



## 8.2

### Display Mode

#### Description

Set the display mode of the CAD by clicking one of the active view mode buttons in the CAD window.

#### Buttons

Button	Description
	<b>2D</b> Enables 2D drawing display.
	<b>3D</b> Enables 3D drawing display.
	<b>Maps</b> Enables 2D display of a reference map.

Button	Description
	<b>Augmented Reality</b> Enables the use of augmented reality.

### 3D view step-by-step



#### Activating 3D visualisation of the drawing

Step	Description
1.	Tap  .

#### Buttons

Button	Description
	<b>Views</b> Select one of the predefined views using the faces of the cube.

#### Commands

Button	Description
<b>Change view</b>	Click on the graphic area and drag to change the point of view.
<b>Pinch out</b>	Tap in the graphic area using two fingers and move them apart to zoom in. 
<b>Pinch in</b>	Tap in the graphic area using two fingers and bring them closer together to zoom out. 



### Using maps step-by-step

X-PAD allows the use of different types of maps as references for the survey and stakeout activities. All data are displayed as overlap to a map.

Select between Google maps, Bing, OpenStreet, TIFF, GeoTIFF raster map and others.

GeoTIFF includes the parameters for the positioning and sizing of the image map. When a GeoTIFF raster map is imported, it is displayed in the right position and with the right scale.



On the main maps, overlap the Web Map Service (WMS) maps, provided by government agencies or other offices, that represent more elements typical of the area and interesting for the surveying activities.

Step	Description
1.	Tap  .
2.	Tap  .

## Select maps for visualisation

Step	Description
1.	Tap  <ul style="list-style-type: none"><li>• <b>On-line maps</b> page A list of available maps. Choose the desired map or choose <b>None</b> if you want no main map but only WMS maps.</li><li>• <b>On-line WMS</b> A list of WMS maps defined. More than one WMS map can be displayed.</li></ul>

## Web Map Server maps (WMS)

Step	Description
1.	Tap  .
2.	Click <b>On-line WMS</b> .
3.	Tap  <ul style="list-style-type: none"><li>• <b>Name</b> Name to assign to the WMS map.</li><li>• <b>Url</b> Address of the WMS map</li><li>• <b>User</b> User name for accessing the WMS service, if necessary</li><li>• <b>Password</b> Password for accessing the WMS service, if necessary</li><li>• <b>Layer</b> Select the layer to visualise among the ones available in the server</li><li>• <b>Projection</b> Projection used by the WMS service</li><li>• <b>Use cartographic system</b></li></ul>

## Creating maps to use in off-line mode

Step	Description
1.	Make the reference map and eventually the WMS maps visible before proceeding to save an off-line map.
2.	Select <b>Data</b> .
3.	Select <b>Save off-line map</b> .
4.	Save the map.
5.	Set the view in order to include the zone you are interested in, to save for off-line mode use. <ul style="list-style-type: none"><li>• <b>Map name</b> Name for the off-line map</li><li>• <b>Zoom Min.</b> Minimum zoom level</li><li>• <b>Zoom Max.</b> Maximum zoom level</li><li>• <b>Tiles count</b> Based on the limits of the zone and of the zoom, the number of tiles to be downloaded is calculated.</li></ul> <p> The number of tiles can be great and request much time to complete downloading and take up much space on the disk. It is recommended to not exceed in the extension of the required zone and to save only the necessary levels of zoom.</p>
6.	When the download of all tiles is finished, the off-line map is available and can be used.

## Using off-line mode maps

Step	Description
1.	Tap  .
2.	Click <b>Use off-line maps</b> .

Step	Description
3.	Select one of the available off-line maps for display.

### Saving the current view as image



Step	Description
1.	Tap  .
2.	Click <b>Save screenshot</b> .
3.	Current view is saved as image file.

### Augmented reality

Step	Description
1.	Tap  .
2.	Click <b>Camera (AR)</b> .
3.	The photo camera of the device is activated. Based on the GPS position, the parameters of the inclination and the direction of the device, the image from camera is shown on the map as overlap.



### GPS navigation mode

Step	Description
1.	Tap  .
2.	Click <b>Locate me</b> . The current position is displayed on the map. A coordinate system is required. Current position is kept inside the graphic view. For displaying the current position, the software can use the connected receiver or the GPS inside the instrument.
3.	Tap  .
4.	Click <b>Stop locate</b> .





## 8.3





## Project Manager

### Description

**Project Manager** is a panel that allows access to the management and modification of the several types of entities that can be displayed in the CAD window.

Step	Description
1.	Tap  .
2.	Click <b>Project Manager (Tablet)</b> .
3.	Tap  .
4.	Click <b>Data</b> .



### Buttons

Button	Description
	<b>Layer</b> Access the layer management and graphical properties of drawing elements.
	<b>External references</b> Access the external reference management.
	<b>Surfaces</b> Access the management of display and properties of the surfaces.
	<b>BIM surface</b> Access the management of the display of the entities present in the files type IFC.



### Layer management step-by-step

Step	Description
1.	Tap  .
2.	Click <b>Layers</b> .

### Setting the current layer

Step	Description
1.	Tap  .
2.	The current layer is marked by  .

### Creating a layer



Step	Description
1.	Tap  .
2.	Click  .
3.	Insert the name of the layer.
4.	Click <b>OK</b> .

### Changing the name of a layer



Step	Description
1.	Tap  .

Step	Description
2.	Click <b>Rename</b> .
3.	Change the name of the layer.

### Making a layer visible or invisible

Step	Description
1.	Visible layers are marked by  . Invisible layers are marked by  .
2.	Click the symbol to change the visibility of a layer.

### Making all layers visible or invisible

Step	Description
1.	Tap  .
2.	Click <b>All ON</b> .
3.	Tap  .
4.	Click <b>All OFF</b> .

### Change the colour or line type

Step	Description
1.	To change colour of a layer: Click the panel of colours to access the window with settings of colours.
2.	To change line type of a layer: Click the name of the line type to access to the window with settings of line types.

### Deleting unused layers

Step	Description
1.	Tap  .
2.	Click <b>Delete unused layers</b> .
3.	All layers without drawing elements are deleted automatically.

### Deleting layers

Step	Description
1.	Tap  .
2.	Click <b>Delete layers</b> .
3.	Select layers to delete. All connected drawing entities are also deleted.

### External reference step-by-step

Step	Description
1.	Tap  .
2.	Click <b>External references</b> .
3.	Refer to <a href="#">25 External References</a> for information about importing DXF/DWG files, X-PAD documents, IFC files and raster maps.

## Surfaces step-by-step



Step	Description
1.	Tap  .
2.	Click <b>Surfaces</b> .
3.	Refer to <a href="#">22 Volumes and Surfaces</a> for information about surface management.

## BIM items step-by-step

The Industries Foundation Classes (IFC) format is the reference for the BIM methodology.

The file has a data structure divided into classes. Each class has objects. Using an IFC file as an external reference makes all the classes and objects in the file available in the CAD window.

In a panel of the Project Manager, the display state of a class or objects for each IFC file linked can be changed.

Step	Description
1.	Tap  .
2.	Click <b>BIM Tools</b> .
3.	Change the display state of a class or objects for each IFC file linked. Tab  or  .

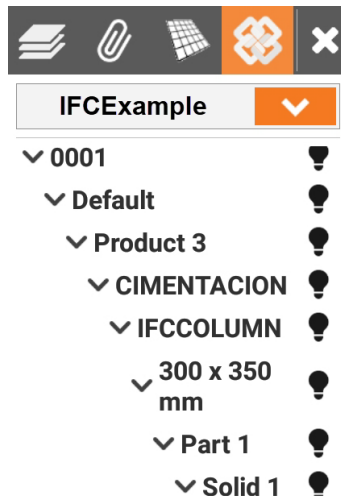

4.	Tap  to change the display parameters.
----	---

## 8.4

### CAD Settings

#### Description

Functioning of CAD is ruled by a parameters and options fully customisable by the operator and editable in every moment.

Step	Description
1.	Tap  .
2.	Click <b>Settings</b> .



#### Survey settings

The page allows setting survey data for visualisation in the graphic window.

Field	Description
<b>Topographic points</b>	Turns the display of stored points on or off.
<b>Reference points</b>	Turns the display of reference points on or off.
<b>Stakeout points</b>	Turns the display of stakeout points on or off.
<b>Measure lines</b>	Turns the display of measured lines on or off.
<b>Drawing by codes</b>	Turns the display of drawing by codes on or off.



**Display filters**

Field	Description
<b>Main drawing</b>	Turns the display of drawing elements on or off.
<b>External references</b>	Turns the display of elements stored in the external reference on or off.
<b>Use linetypes</b>	Turns the display of line types associated with the drawing elements on or off.
<b>Line double thickness</b>	<p>Turns the display of drawing elements with a doubled thickness on or off.</p> <p>Displaying elements in double thickness makes them better visible. This is very useful in conditions with low visibility as, for example, sun exposure.</p> <p>Normal thickness:  Double thickness: </p>
<b>Mono color drawing</b>	Turns the display of colours for drawing elements on or off.
<b>Autocenter in drawing</b>	Turns the autocentering of the drawing on or off. During drawing operations, each time a CAD location is set, it is shown in the center of the graphical window.
<b>Grid</b>	Turns the display of the grid in the CAD window on or off.
<b>Grid step</b>	Defines the steps of the grid.

**AR settings**

Field	Description
<b>Height from ground</b>	Sets the height of the point of view, when augmented reality display mode is active.
<b>Radar</b>	Turns on the plan view in the bottom right panel.

**CAD background**

Field	Description
<b>Style</b>	To customise the background colour of the CAD in the main view. This option is very useful if light colors like yellow or light gray are used for drawing objects.

**8.5**

**Description**

**Import and Export**

**Importing DWG/DXF files**

Step	Description
1.	Tap  .
2.	Click <b>DWG/DXF In</b> .
3.	Refer to <a href="#">26 Data Import</a> for information about importing DXF/DWG files.

## Exporting DXF files

Step	Description
1.	Tap  .
2.	Click <b>DXF Out</b> .
3.	Refer to <a href="#">27 Data Export</a> for information about exporting DXF files.

## 8.6



### Object snapping step-by-step

## Object Snap

Object snapping allows the precise identification of positions on drawing objects.



If object snap is inactive, free drawing indicating every position is available.

Step	Description
1.	Tap  .
2.	Click <b>Snap</b> . <ul style="list-style-type: none"><li>• <b>Extreme</b> End point of objects such as lines and arcs.</li><li>• <b>Medium</b> Middle of objects such as lines and arcs.</li><li>• <b>Perpendicular</b> Point on the normal of a line, arch, circle object referring to the reference point.</li><li>• <b>Intersection</b> Intersection point between objects such as lines and arcs.</li><li>• <b>Node</b> Point of insertion of a topographic point.</li><li>• <b>Center</b> Center of an arc or circle.</li><li>• <b>Tangent</b> Point of the tangent from the reference point to an arc or circle.</li><li>• <b>Nearest</b> The nearest element is selected.</li></ul>
3.	Select a command for object snapping.  To snap to a topographic point, <b>None</b> or type in the position or name of the point.
4.	Click on the drawing object and near the point to identify. The multiple snap mode makes that the element gets snapped to the right coordinate if there are multiple options for it to be fixed to. The symbol corresponding to the selected snap is displayed before to get the coordinates. 
5.	A symbol is added at the identified position. The symbol represents the type of snap used to identify the position.

## 8.7

### Drawing functions step-by-step

## Drawing Functions

Use the drawing commands to add new objects to a drawing.



For a precise drawing, use the object snap or type in the name of the point to which to link the vertex of the line.

Step	Description
1.	Tap  .

Step	Description
------	-------------

2. Click **Draw**.
- **Topographic point**  
Indicate the name of the point and then the position of insertion.
  - **Lines and Polyline**  
Indicate points composing lines or polylines. Polylines can be opened and closed, vertices can be added and removed, segments can be removed.
  - **Arc**  
Indicate three points composing the arc.
  - **Circle**  
Indicate the centre of the circle and specify the value of the radius or indicate the point of passage.
  - **Circle 2P**  
Indicate the two points that identify the diameter of the circle.
  - **Circle 3P**  
Indicate the three points composing the circle.
  - **Parcel**  
Specify vertexes of the parcel. To close a parcel indicate the first vertex again. The corners of the parcel must be topographic points.
  - **Spline**  
Transform polylines in splines.
  - **Text**  
Specify text to insert, dimensions and rotation angle then specify the insert position.
  - **Layout**  
Draws consecutive elements setting distances and angles from a starting point. The starting point can be a topographic point or any other position.
  - **BIM Tools**  
Allows several operations if surfaces from an IFC file are loaded.

3. A small symbol on the vertices of the selected entity is displayed. Vertices of the element are in this way better identified.

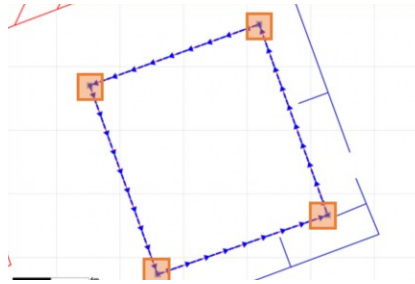



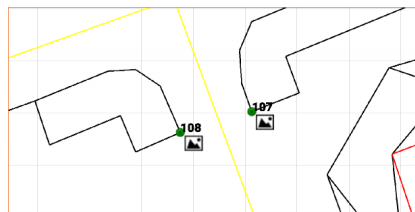

4. Topographic points that have a photo or a sketch attached are displayed with a specific symbol. Tap for a longer while on the point to open the dialogue with the photo or sketch.



### Inserting drawing elements step-by-step



Draw a line, polyline, arc or circle in one of the following ways:

- **Selection in the CAD window**  
Select the points in the window. The points are the vertexes of the elements. If an object has been selected, it can be unselected by clicking on it again. Or tap  **Select all** and  **Unselect all**.
- **Entering point name**  
Enter the name of the stored point in the box below the CAD window. The point corresponds to the vertex of the element.
- **Select point**  
Tap  in the box below the CAD window to access the insertion options.





Step	Description
1.	Tap  .
2.	Click <b>Draw</b> .
3.	Tap  .
4.	Use one of the following options to set the vertices of the drawing element: <ul style="list-style-type: none"> <li>• <b>Topographic points</b> Select the vertices of the element from a list of topographic points.</li> <li>• <b>Reference points</b> Select the vertices of the element from a list of reference points.</li> <li>• <b>Mode</b> Set a sequence of points by selecting the first and last point of the element. To join the points select: <ul style="list-style-type: none"> <li>• <b>Incremental</b> Joins the points according to the numerical part of the name.</li> <li>• <b>Sequential</b> Joins the points using the order of the topographical point table.</li> </ul> </li> <li>• <b>Coordinates</b> Enter the vertices of the coordinates. The coordinates can be <b>Absolute</b>, <b>Relative</b> or <b>Polar</b>.</li> </ul>

### Drawing layout step-by-step

Draw lines and arcs starting from a point of origin.

Step	Description
1.	Tap  .
2.	Tap  .
3.	Select the items to insert. <ul style="list-style-type: none"> <li>• <b>Points and lines</b> Enables the drawing of lines, arcs, and points.</li> <li>• <b>Only points</b> Enables the creation of points only.</li> <li>• <b>Only lines</b> Enables the draw of lines only.</li> <li>• <b>Elevation</b> Enables the insertion of the elevation for created items. When disabled, the program assigns the elevation start point to the items that are created.</li> </ul>
4.	Click <b>OK</b> .

### Drawing mode

Field	Description
<b>Draw</b>	Choose the drawing element to create and calculate the second point. Use a line or an arc.
<b>Point</b>	Set the insertion point in one of the following ways: <ul style="list-style-type: none"> <li>• Select the point in the CAD window.</li> <li>• Click in the box to insert the point name.</li> <li>• Click  to select the point from the list of topographic points or from the list of reference points.</li> </ul>  The starting point can be defined every time again after drawing an element.
<b>Distance</b>	Sets the distance from the starting point to draw the line. Enter the value in one of the following ways: <ul style="list-style-type: none"> <li>• Type in the value in the box.</li> <li>• Click  and select <b>By two points</b> to set the value of distance using the distance between the two selected points.</li> </ul>
<b>Azimuth Direction</b>	Sets the azimuth. Enter the value in one of the following ways: <ul style="list-style-type: none"> <li>• Type in the value in the box.</li> <li>• Press <b>Up</b> and <b>Down</b> to increase or decrease the value based on the increment value set.</li> <li>• Click  and select <b>By two points</b> to set the azimuth value based on angle between the two selected points.</li> </ul>
<b>Angle</b>	Sets the angular development value of the arc.

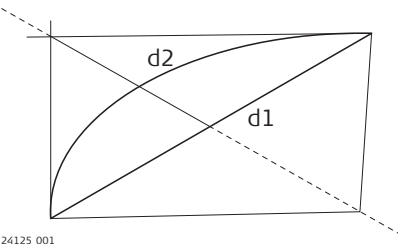

Field	Description
<b>Increment</b>	Sets the value the software adds or subtracts in the azimuth input, when using <b>Up/Down</b> .
<b>Radius</b>	Sets the arc radius value and direction using <b>→</b> and <b>←</b> .
<b>Chord Length</b>	 <p>d1 Chord d2 Length of the arc</p>
<b>Elevation</b>	Set the value of the elevation. Enter the value in one of the following ways: <ul style="list-style-type: none"> <li>Type in the value in the box.</li> <li>Click <b>→</b> and select the elevation input mode.</li> </ul>



Use the curve calculator tool to calculate all the curve data.

### Example

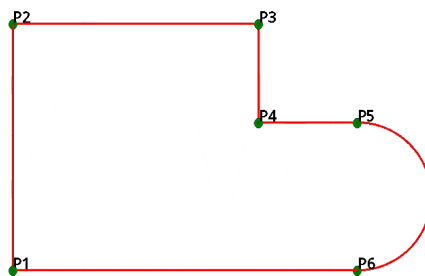

Task:  
Draw a similar layout.

Step	Description
<b>Line P1 - P2</b>	
1.	Measure or enter the coordinates of point P1.
2.	Set <b>Draw: Line</b> .
3.	Set <b>Point: P1</b> .
4.	Set <b>Distance: 5 m</b> .
5.	Set <b>Azimuth: 0 c</b> .
6.	Click <b>Add point</b> .
<b>Line P2 - P3</b>	
7.	Set <b>Draw: Line</b> .
8.	Set <b>Point: P2</b> .
9.	Set <b>Distance: 8 m</b> .
10.	Set <b>Azimuth: 100 c</b> .
11.	Click <b>Add point</b> .
<b>Line P3 - P4</b>	
12.	Set <b>Draw: Line</b> .
13.	Set <b>Point: P3</b> .
14.	Set <b>Distance: 2 m</b> .
15.	Set <b>Azimuth: 200 c</b> .



Step	Description
16.	Click <b>Add point</b> .
<b>Line P4 – P5</b>	
17.	Set <b>Draw: Line</b> .
18.	Set <b>Point: P4</b> .
19.	Set <b>Distance: 2 m</b> .
20.	Set <b>Azimuth: 100 c</b> .
21.	Click <b>Add point</b> .
<b>Arc P5 – P6</b>	
22.	Set <b>Draw: Arc</b> .
23.	Set <b>Point: P5</b> .
24.	Set <b>Azimuth: 100 c</b> .
25.	Set <b>Angle: 200 c</b> .
26.	Set <b>Radius: 1.5 m</b> .
27.	Click <b>Close</b> to draw the line P5 – P1.

## 8.8

### Drawing tools for BIM step-by-step

### Drawing Tools for BIM

Extract points or polylines from an IFC/BIM model for subsequent operations.

Step	Description
1.	Tap  .
2.	Tap  .
3.	<ul style="list-style-type: none"> <li>• <b>Points from surface</b> Automatically insert topographic points at the vertices of selected 3D objects.</li> <li>• <b>Lines from surface</b> Automatically insert topographic points at the edges of selected 3D objects.</li> <li>• <b>Polylines from Horizontal section</b> Extract the line of a horizontal section from the model. The model is cut using a horizontal plane based on the specified elevation. The command can create section lines as well as points at the intersection of the plane with the IFC elements.</li> <li>• <b>Polylines from Vertical section</b> Extract the line of a vertical section from the model. The model is cut using a vertical plane based on selected points. The command can create section lines as well as points at the intersection of the plane with the IFC elements.</li> </ul>
4.	Tap <b>Info</b> to access all design properties of the BIM elements on the construction site.

#### Points from surface

Step	Description
1.	Select the surface.
2.	Click <b>OK</b> .
3.	Confirm the insertion of the points by clicking <b>OK</b> .
4.	Enter the name of start point. The following points have subsequent numbers.
5.	Set the layer.

#### Lines from surface

Step	Description
1.	Select the surface.
2.	Click <b>OK</b> .
3.	Confirm the insertion of the points by clicking <b>OK</b> .

Step	Description
4.	Set the layer.

#### Polylines from Horizontal section

Step	Description
1.	Enter the elevation of the horizontal plane.
2.	Click <b>OK</b> .
3.	Add lines or select a layer.
4.	Add points if necessary.
5.	Click <b>OK</b> .
6.	The software shows the number of items that are created. Click <b>OK</b> to confirm.

#### Polylines from Vertical section

Step	Description
1.	Select the first point of the vertical cutting plane.
2.	Click <b>OK</b> .
3.	Select the second point of the vertical cutting plane.
4.	Click <b>OK</b> .
5.	Add lines or select a layer.
6.	Add points if necessary.
7.	Click <b>OK</b> .
8.	The software shows the number of items that are created. Click <b>OK</b> to confirm.

## 8.9

### Creating and Editing of Points

#### Creating and editing of points step-by-step

Modify the drawing and create new objects starting from existing ones.

Step	Description
1.	Tap  .
2.	Click <b>Edit</b> .

#### Deleting an object step-by-step

Step	Description
1.	Select objects tracing a selection window.
2.	Click <b>Delete</b> .

#### Distance intersection step-by-step

Calculate the position of a new topographic point located at a certain distance from two reference points.

Step	Description
1.	Click <b>Int 2 Dist</b> .
2.	<b>First point.</b> Select first reference point.
3.	<b>First distance.</b> Enter the distance from the first reference point.
4.	<b>Second point.</b> Select the second reference point.

Step	Description
5.	<b>Second distance.</b> Enter the distance from the second reference point.
6.	<b>Select solution.</b> The two possible solutions are proposed. Select the desired solution.

### Intersection step-by-step

Calculate the position of a topographic point that is on the intersection of two straight lines.

Step	Description
1.	Click <b>Int 4 Points</b> .
2.	<b>First point.</b> Select the first point of the first straight line.
3.	<b>Second point.</b> Select the second point of the first straight line.
4.	<b>Third point.</b> Select the first point of the second straight line.
5.	<b>Fourth point.</b> Select the second point of the second straight line.
6.	<b>Insert points.</b> Confirm to proceed to insertion point.

### Distance and offset step-by-step

Calculate the position of a new topographic point referring to a reference object.

Step	Description
1.	Click <b>Dist&amp;Offset</b> .
2.	<b>Select object.</b> Select the reference object referring to which to calculate the position of the point.
3.	<b>Distance.</b> Distance along the reference object.
4.	<b>Offset.</b> Distance from the reference object.
5.	<b>Select solution.</b> Two possible solutions are displayed. Select the desired solution.

### Dividing step-by-step

Calculate the position of new topographic points along a reference object dividing it in a specific number of parts.

Multiple objects can be selected. The new points are created on all selected objects in one single step.

Step	Description
1.	Click <b>Divide</b> .
2.	<ul style="list-style-type: none"> <li>• <b>Select object</b> Select the reference object on which to create the topographic points. Select one or more objects.</li> <li>• <b>Number of parts</b> Number of sections in which to divide the reference object.</li> <li>• <b>First point</b> Name of first topographic point to create.</li> </ul>

### Measuring step-by-step

Calculate the position of new topographic points along a reference object dividing it by a constant distance.

Multiple objects can be selected. All selected objects are divided in one single step.

Step	Description
1.	Click <b>Measure</b> .

Step	Description
2.	<ul style="list-style-type: none"> <li>• <b>Select object</b> Select the reference object on which to create the topographic points. Select one or more objects.</li> <li>• <b>Segment length</b> Distance between the points. Use a value of 0, to insert points at the vertexes of the polyline.</li> <li>• <b>First point</b> Name of first topographic point to create.</li> </ul>

### Offsetting step-by-step

Create an object parallel to reference object at a defined distance.

Step	Description
1.	Click <b>Offset</b> .
2.	<ul style="list-style-type: none"> <li>• <b>Select object</b> Select the reference object.</li> <li>• <b>Offset</b> Enter the 2D perpendicular offset distance.</li> <li>• <b>Vertical offset</b> Enter the vertical offset distance.</li> <li>• <b>Select solution</b> The two possible solutions are proposed. Select the desired solution.</li> <li>• <b>Repeat</b> Number of consecutive offset to execute.</li> </ul>

### Lengthening step-by-step

Extend an object like a line, a polyline or an arc to a defined length.

Or extend a line defined by two points which also indicates the direction where to create the point.

Step	Description
1.	Click <b>Lengthen</b> .
2.	<ul style="list-style-type: none"> <li>• <b>Distance</b> Distance by which to lengthen an object.</li> <li>• <b>Select object</b> or <b>First point</b> Select the reference object or the first point.</li> <li>• <b>Second point</b> For <b>First point</b>: Select the second point.</li> </ul>

### Exploding step-by-step

Transform selected polylines such as lines and circles into the base elements composing it.

Step	Description
1.	Click <b>Explode</b> .
2.	The original polyline is deleted and substituted by the base elements.

### Inverting step-by-step

Reverse the vertex order of a drawing element.

Step	Description
1.	Click <b>Invert</b> .



### Joining step-by-step

Merge several entities so that they have one point in common. Example: Multiple lines that must be managed as a single polyline.

Step	Description
1.	Click <b>Join</b> .
2.	Select the objects to merge.
3.	Tap <b>OK</b> .

### Object properties step-by-step

Access the management of the graphical properties of the selected objects such as layer, colour and linetype.

Step	Description
1.	Tap  .
2.	Select the object by drawing a selection window.
3.	Tap  .
4.	Click the object.

## 8.10

### Information Commands

#### Information commands step-by-step

Obtain different information from drawing and from present objects.

Step	Description
1.	Tap  .
2.	Click <b>Info</b> .

#### Coordinate of a point step-by-step

Provides information about the selected position.

Step	Description
1.	Click <b>ID</b> .
2.	Click on a point.
3.	The coordinates of the selected position are displayed.

#### Distance between two points step-by-step

Provides information about the distance between two points.

Step	Description
1.	Click <b>Distance</b> .
2.	<ul style="list-style-type: none"><li>• <b>First point</b> Select the first point.</li><li>• <b>Second point</b> Select the second point.</li></ul>
3.	The distance (ground and ellipsoidal) and other information such as azimuth (ground and ellipsoidal) and slope between two points are displayed.

#### Distance between point and object step-by-step

Provides information about the distance between a point and an object.

Step	Description
1.	Click <b>Dist.Object</b> .
2.	<ul style="list-style-type: none"><li>• <b>Reference point</b> Select the reference point.</li><li>• <b>Select object</b> Select the object to which to calculate distance.</li></ul>
3.	Displayed is: <ul style="list-style-type: none"><li>• Distance from the point to the object</li><li>• Chainage of the projection of the point to the object</li></ul>
4.	Click <b>Save</b> to create a point on projection of the point on the object.

#### Angle step-by-step

Provides information about the angle between three points.

Step	Description
1.	Click <b>Dist.Object</b> .

Step	Description
2.	<ul style="list-style-type: none"> <li>• <b>Center point</b> Select the centre of the angle.</li> <li>• <b>First point</b> Select first point.</li> <li>• <b>Second point</b> Select the second point.</li> </ul>
3.	Displayed is angle included and the complementary angle.

### Area step-by-step

Provides information about the area of a polygon formed by a sequence of points.

Step	Description
1.	Click <b>Area</b> .
2.	<ul style="list-style-type: none"> <li>• <b>First point</b> Select the first point.</li> <li>• <b>Next point</b> Select the following point.</li> </ul>
3.	Displayed is: <ul style="list-style-type: none"> <li>• Area of the polygon</li> <li>• Perimeter of the polygon</li> </ul>
4.	Enter a height to calculate the volume.



### List step-by-step

Provides information about a selected object.

Step	Description
1.	Click <b>List</b> .
2.	<ul style="list-style-type: none"> <li>• <b>Select object</b> Select an object.</li> </ul>
3.	Displayed are the object properties such as layer, colour, and line type. The properties are editable.

### Report step-by-step

Creates a document that has information about selected objects including information about the length, the area and the number of vertices.

The document is exportable.

Step	Description
1.	Click <b>List</b> .
2.	<ul style="list-style-type: none"> <li>• <b>Select object</b> Select an object.</li> <li>• <b>Report type</b> Select the report type for exporting. <ul style="list-style-type: none"> <li>• ASCII</li> <li>• CSV for Excel</li> <li>• XML for Excel</li> <li>• PDF</li> <li>• HTML</li> </ul> </li> </ul>

### Find topographic point step-by-step

Brings a topographic point into the center of the graphic window.

Step	Description
1.	Click <b>Find</b> .
2.	<ul style="list-style-type: none"> <li>• <b>Name</b> Name of the topographic point to find.</li> </ul>

### Longitudinal profile step-by-step

Displays the longitudinal profile of the selected polyline including additional information about the polyline.

Step	Description
1.	Click <b>Longitudinal profile</b> .
2.	<ul style="list-style-type: none"> <li>• <b>Select polyline</b> Select the polyline.</li> </ul>

## 8.11

### Toolbar

#### Toolbar for points step-by-step

Step	Description
1.	Select a topographic point without any command being active.
2.	A toolbar with context commands is displayed.



<ul style="list-style-type: none"> <li>• <b>Stakeout</b> Starts the stakeout procedure. Refer to <a href="#">14 GPS - Stakeout</a> for further information.</li> <li>• <b>ID</b> Opens the window allowing to display and edit the data of the point.</li> <li>• <b>Distance</b> Calculates the distance from the selected point to another point for displaying in the graphic window.</li> <li>• <b>Dist.Object</b> Calculates the distance from the selected point to an object for displaying in the graphic window.</li> <li>• <b>Delete</b> Deletes the selected point.</li> <li>• <b>Isolate</b> Turns off all layers, except the layer of the selected point. To restore the previous display, select a point and click <b>Restore layers</b>.</li> </ul>	
3.	Click anywhere else in the graphic window. The main toolbar appears again.

#### Toolbar for CAD objects step-by-step

Step	Description
1.	Select a drawing object without any command being active.

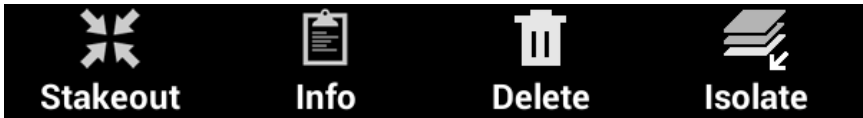

Step	Description
2.	A toolbar with context commands is displayed.
	
	<ul style="list-style-type: none"> <li>• <b>Stakeout</b> Opens the window allowing to select if the object is for stakeout or a reference line. Starts the stakeout procedure. Refer to <a href="#">14 GPS - Stakeout</a> for further information.</li> <li>• <b>Info</b> Opens the window allowing to display and edit the data of the object. When an area is selected as object, it is possible to enter the height and calculate a volume.</li> <li>• <b>Delete</b> Deletes the selected object.</li> <li>• <b>Isolate</b> Turns off all layers, except the layer of the selected object. To restore the previous display, select an object and click <b>Restore layers</b>.</li> </ul>
3.	Click anywhere else in the graphic window. The main toolbar appears again.

# 9

## Instrument Settings

### Description

- Set the connection between the instrument and a device
- Define parameters for the operation between the instrument and a device

All parameters of connection and operation are organised in profiles. A profile has the connection mode of the instrument and all related operation parameters.

For the same instrument, different profiles with different operation parameters can be created and recalled.



Among all profiles available only one is the current profile. The current profile is used during the use of the software.

Step	Description
1.	Tap <b>Settings</b> .
2.	Tap <b>GNSS &amp; Total stations</b> .

Icon	Name	Description	Connection Type
	<b>NMEA Simul.</b>	NMEA - NMEA Simulation	Rover
	<b>GeoMax - Zoom 90</b>	GeoMax - Zoom 70/90	TPS
	<b>GeoMax - GNSS Zenith 35PRO</b>	GeoMax - GNSS Zenith 35PRO	Rover
	<b>GeoMax - GNSS Zenith 25</b>	GeoMax - GNSS Zenith 25	Rover
	<b>NMEA - GPS Hardware</b>	NMEA - GPS Hardware	Rover
	<b>GeoMax - GNSS Zenith 35</b>	GeoMax - GNSS Zenith 35	Rover

Icon	Description
	Current profile
	Rover GPS without RTK connection
	Rover GPS with GPRS RTK connection
	Rover GPS with radio RTK connection

Icon	Description
	Base GPS
	Total station

## Tools of the Instruments page

### Save the current settings as profile

Step	Description
1.	Tap <b>Settings</b> .
2.	Tap <b>GNSS &amp; Total stations</b> .
3.	Select the profile.
4.	Tap <b>Current</b> .

### Editing a profile

Step	Description
1.	Tap <b>Settings</b> .
2.	Tap <b>GNSS &amp; Total stations</b> .
3.	Select the profile.
4.	Tap <b>Modify</b> .

### Deleting a profile

Step	Description
1.	Tap <b>Settings</b> .
2.	Tap <b>GNSS &amp; Total stations</b> .
3.	Select the profile.
4.	Tap <b>Delete</b> .

### Reconfigure instruments

Step	Description
1.	Tap <b>Settings</b> .
2.	Tap <b>GNSS &amp; Total stations</b> .
3.	Select the profile.
4.	Tap <b>Configure</b> .
5.	The instrument is reprogrammed based on the settings defined in the profile.

### Reorganise the list according to the most used profiles

Step	Description
1.	Tap <b>Settings</b> .
2.	Tap <b>GNSS &amp; Total stations</b> .
3.	Select the profile.
4.	Tap <b>Move on top of the list</b> .

Step	Description
5.	Moves the selected profile to the top of the list.

## 9.1

### Creating a profile for GPS receiver step-by-step

## Creating a Profile for GPS Receiver

Step	Description
1.	Tap <b>Settings</b> .
2.	Tap <b>GNSS &amp; Total stations</b> .
3.	Click <b>+</b> .
4.	Tap <b>GNSS Receiver (GNSS)</b> .

Parameters and options requested are different according to the model of the receiver and the operation mode.

Parameters and options are organised in pages.

### Profile page

Field	Description
<b>Profile name</b>	Name to assign to the profile
<b>Mode</b>	<ul style="list-style-type: none"> <li><b>GNSS Rover</b> Receiver operates as rover</li> <li><b>GNSS Base</b> Receiver operates as base</li> </ul>
<b>Brand</b>	Brand of the receiver
<b>Model</b>	Model of the receiver

### Device page

Field	Description
<b>Device</b>	Name of the Bluetooth to connect. To start a search in case the instrument is not in the list, hit <b>🔍</b> and then <b>🔍</b> .

### RTK page

Field	Description
<b>Device</b>	Type of device to use to send (base) and receive (rover) differential corrections. Possible options are: <ul style="list-style-type: none"> <li><b>None</b> No RTK connection. Receiver operates in autonomous mode.</li> <li><b>Internal radio</b> Use of internal radio of receiver</li> <li><b>Internal GPRS (receiver)</b> Use of internal GPRS modem of receiver</li> <li><b>External radio</b> Use of an external radio to receiver</li> <li><b>External GPRS (controller)</b> Use of the GPRS modem of the device (controller) or the Internet connection of the controller</li> </ul>
<b>RTK Extra-Safe</b>	Available for Zenith 35/Zenith 60. Using extra safe in environments with signal partially blocked allows to have a solution slower getting the fix status but likely less to be erroneous.

## RTK Radio page



In order to accomplish radio regulations active in several countries, the access to some advanced settings (radio frequencies and spacing.) of the radio are now protected by a password. The password is provided only to dealers and support team.

Field	Description
<b>Channel</b>	Radio channel to use for transmitting and receiving. Base and rover must use the same channel and the same frequency. Select <b>Frequencies...</b> from the list and set the frequencies to use for the different channels.
<b>Protocol</b>	Depending on the GNSS receiver model, the selectable options are: <ul style="list-style-type: none"> <li>• Satel 3AS</li> <li>• Satel 4-FSK/3AS</li> <li>• Satel 8FSK</li> <li>• Satel 16FSK</li> <li>• Pacific Crest 4-FSK</li> <li>• Pacific Crest FST</li> <li>• Pacific Crest GMSK</li> <li>• TRIMTALK GMSK 450S(P)</li> <li>• TRIMTALK GMSK 450S(T)</li> </ul>
<b>Spacing</b>	Spacing parameter
<b>High Power</b>	Radio with high-power
<b>FEC (Frequency Error Check)</b>	If enabled on the base, it must be enabled on the rover, too.
<b>Format</b>	Format of corrections. base and rover must use the same data format.
<b>Use Base ID</b>	For <b>Rover</b> : Sets the receiver to receive the corrections only from the base identified by the specified <b>Base ID</b> For <b>Base</b> : Sets the name of the base.
<b>Base ID</b>	Identification of the base

## RTK GPRS page

Field	Description
<b>Provider</b>	Name of the phone provider providing GPRS service. Select a provider to define a new provider or to modify parameters of an existing provider. Refer to <a href="#">Managing profiles of Internet providers step-by-step</a> .
<b>Server</b>	<ul style="list-style-type: none"> <li>• <b>NTRIP</b> Name of the permanent station service to connect. Define a service or to modify parameters of an existing service. Refer to <a href="#">Managing profiles of NTRIP</a>.</li> <li>• <b>CSD (Direct call)</b> Name of the profile. Refer to <a href="#">Managing profiles of direct call</a>.</li> </ul>
<b>Mountpoint</b>	Name of mountpoint to use. Type in the name or select from a list. Only if an NTRIP server has been set.
<b>Format</b>	Data format of corrections. Set the same data format sent by permanent station (source).
<b>Network type</b>	Available for Zenith 15, Zenith 16, Zenith 25 and Zenith 40. Type of network to use. Only if an NTRIP server NTRIP has been set.
<b>RTCM3.1 messages</b>	When activated, the software can process some of the messages provided by the RTCM3.1 protocol. In particular: <ul style="list-style-type: none"> <li>• Messages referring to transformation parameters of the coordinate system</li> <li>• Messages referring to corrections to apply for coordinates calculation</li> </ul> <p>To use this option correctly, a correct cartographic system must be set to which corrections and transformation parameters have to be applied.</p>

Field	Description
<b>RTCM3.1 mode</b>	RTCM3.1 messages can be used in following modes: <ul style="list-style-type: none"> <li>• <b>Horizontal &amp; Vertical</b> Correction and calculation of coordinates and of elevations</li> <li>• <b>Horizontal only</b> Correction and calculation only of coordinates</li> <li>• <b>Vertical only</b> Correction and calculation only of elevations</li> </ul>
<b>Send GPUID to server</b>	Send information of user identification to a server to obtain the authorisation to use some service.

#### Parameters page

Field	Description
<b>Satellites Cut-off angle(°)</b>	Minimum elevation above the horizon in degrees to consider satellites usable. To increase precision by avoiding satellites too low above the horizon.
<b>Tracking GPS L2C</b>	Available for Zenith 15, Zenith 16, Zenith 25 and Zenith 40.
<b>Use GLONASS</b>	Enables the use of satellites in the GLONASS constellation.
<b>Use GALILEO</b>	Enables the use of satellites in the GALILEO constellation.
<b>Use BEIDOU</b>	Enables the use of satellites in the BeiDou constellation.
<b>Use SBAS</b>	Available if <b>None</b> is selected as device on the <b>RTK</b> page. Enables the use of geostationary satellites of SBAS. The receiver can receive correction directly from SBAS satellites and improve the quality of the position without any type of RTK connection (radio or GPRS).
<b>Position update freq.</b>	Frequency with which the value of the position is updated. For tracking operations, use a value of 5 times per second.
<b>RTK Extra-Safe</b>	Available for Zenith 35/Zenith 60. Using extra safe in environments with signal partially blocked allows to have a solution slower getting the fix status but likely less to be erroneous.

#### Antenna page

Field	Description
<b>Model</b>	Type of the antenna of the receiver
<b>Height</b>	Default receiver antenna elevation

#### Managing profiles of Internet providers step-by-step

A provider is the manager providing the service of GPRS data traffic.

Parameters required to define a provider are:

Field	Description
<b>Name</b>	Description of the provider
<b>APN Server</b>	Name of the access point for GPRS and UMTS nets. Example: <a href="https://www.omnitel.biz/">https://www.omnitel.biz/</a>
<b>User ID</b>	identification of the user to access the service. Necessary if the access is protected by a user ID and a password.
<b>Password</b>	Set the password to access the service. Necessary if the access is protected by a user ID and a password.
<b>PIN</b>	PIN to use the SIM card.

#### Managing profiles of NTRIP

An NTRIP server is a permanent station service to connect through the Internet receiving differential corrections in real time.

Parameters required to define An NTRIP server:

Field	Description
<b>Name</b>	Description of the provider
<b>Mode</b>	NTRIP
<b>IP</b>	IP address where the service answers Provided when you register yourself to the service.
<b>Port</b>	Number of the port used Provided when you register yourself to the service.
<b>UserID</b>	Identification of the user registered to the service Provided when you register yourself to the service.
<b>Password</b>	Password assigned to the registered user by the service Provided when you register yourself to the service. For partners who run a rental business, the NTRIP password can be hidden. This prevents the abuse after the rental is completed. Please contact the support team to activate this option.

### Managing profiles of direct call

A direct call profile allows setting the telephone number of the SIM card used by the base.

It allow the rover to receive corrections from the base using the modem GPRS instead of radio.



Base and rover must use the same profile.

Field	Description
<b>Name</b>	Description of the profile
<b>Mode</b>	CSD (Direct call)
<b>Base phone number</b>	Telephone number of the SIM used by the base
<b>Protocol</b>	Available for Zenith10/20, Zenith 25, Zenith 35, Zenith 40 and Zenith 60. Transmission protocol
<b>Speed</b>	Available for Zenith10/20, Zenith 25, Zenith 35, Zenith 40 and Zenith 60. Transmission speed
<b>Connection</b>	Available for Zenith10/20, Zenith 25, Zenith 35, Zenith 40 and Zenith 60. Type of connection

### Managing of Point-To-Point (PPP) profiles

Allows to set the IP address and the port number for the connection to receive corrections.

Field	Description
<b>Name</b>	Description of the profile
<b>Mode</b>	PPP (Point to Point)
<b>IP</b>	IP address to use
<b>Port</b>	Number of the port to use
<b>UserID</b>	Identification of the user registered to the service
<b>Password</b>	Password assigned to the registered user by the service

### Managing dynamic DNS (DDNS) profiles

Available only on Zenith 35, Zenith 35 PRO and Zenith 60.

Set a base and rover system in which the base is able to support up to 10 rovers at the same time using GPRS network.

Field	Description
<b>Name</b>	Description of the profile
<b>Mode</b>	DDNS (Dynamic DNS)

Field	Description
<b>Service Provider</b>	Insert the address of the service provider. Some service providers to use are: <ul style="list-style-type: none"> <li>• DynDNS (default)</li> <li>• easyDNS</li> <li>• No-IP</li> <li>• Two-DNS</li> </ul> It is necessary to subscribe service to one of these providers.
<b>Host name</b>	Host name assigned by the service provider Provided when you register yourself to the service.
<b>Port</b>	Number of the port used
<b>UserID</b>	Identification of the user registered to the service Provided when you register yourself to the service.
<b>Password</b>	Password assigned to the registered user by the service Provided when you register yourself to the service.

## 9.2

### Creating a Profile for Using GNSS on the Controller

#### Description

This profile allows to use the GNSS module inside the Android controller in the X-PAD application.

#### Creating a profile for using GNSS on the controller step-by-step

Step	Description
1.	Tap <b>Settings</b> .
2.	Tap <b>GNSS &amp; Total stations</b> .
3.	Click <b>+</b> .
4.	Tap <b>GNSS Receiver (GNSS)</b> .
5.	Assign a name to profile.
6.	Select <b>Mode: GNSS Rover</b> .
7.	Select <b>Brand: NMEA Output</b> .
8.	Select <b>Model: GNSS Receiver (GNSS)</b> .
9.	Tap <b>⏏</b> .
10.	<b>Antenna H.:</b> Set the default antenna elevation.
11.	Tap <b>☑</b> .

## 9.3

### Creating a Profile for Total Station

#### Creating a profile for total station step-by-step

Step	Description
1.	Tap <b>Settings</b> .
2.	Tap <b>GNSS &amp; Total stations</b> .
3.	Click <b>+</b> .
4.	Tap <b>Total station (TPS)</b> .

Parameters and options requested are different according to the model of the total station and the operation mode.



Parameters and options are organised in pages.

#### Profile page

Field	Description
<b>Profile name</b>	Name to assign to the profile
<b>Mode</b>	Total station
<b>Brand</b>	Brand of the total station
<b>Model</b>	Model of the total station



### Device page

Field	Description
<b>Device</b>	Name of the Bluetooth to connect. To start a search in case the instrument is not in the list, hit  and then  .

### Angles update frequency page

Field	Description
<b>Angles update frequency</b>	Frequency with which the value of the angles is updated. For some instruments, the available maximal frequency is <b>2 times per second</b> . For older models select <b>None</b> .

### Output Measures & Coordinates page

Use the total stations together with other devices, for example ground penetrating radars or echosounders.

Field	Description
<b>Format</b>	Send out measurements and/or the coordinates in real time.
<b>Device</b>	Name of the USB serial port to connect.

## 9.4

### Creating a Profile for Laser Distance Meter

#### Creating a profile for Laser Distance Meter step-by-step

Create one or more profiles related to instruments such as Laser Disto, BOSCH GLM series that uses Bluetooth Low Energy system or ADA Instruments COSMO series.

X-PAD Ultimate can use the profiles for measuring points not accessible by the GPS receiver. The point to measure is calculated by intersecting two distances from two known GPS positions. The distance measurements are done with a Disto and transferred to the software.



Step	Description
1.	Tap <b>Settings</b> .
2.	Tap <b>GNSS &amp; Total stations</b> .
3.	Click  .

Parameters and options are organised in pages.

#### Profile page

Field	Description
<b>Profile name</b>	Name to assign to the profile
<b>Brand</b>	Brand of the Laser Disto
<b>Model</b>	Model of the Laser Disto

#### Device page

Field	Description
<b>Device</b>	Name of the Bluetooth to connect. To start a search in case the instrument is not in the list, hit  and then  .

## Parameters page

Field	Description
<b>Laser height</b>	Elevation from ground of the Laser Disto. The elevation from ground is used for calculation of slopes between GPS position and point to measure.

## 9.5

### Creating a Profile for Echo Sounder

#### Creating a profile for echo sounder step-by-step

Create one or more profiles related to echo sounders.

A profile for echo sounder is used in bathymetric surveys available in the **Bathymetry** module.



Step	Description
1.	Tap <b>Settings</b> .
2.	Tap <b>Echosounder</b> .
3.	Click  .

Parameters and options are organised in pages.

#### Profile page

Field	Description
<b>Profile name</b>	Name to assign to the profile
<b>Brand</b>	Brand of the echo sounder <ul style="list-style-type: none"><li><b>NMEA</b> NMEA format for depth values. Supports a wide variety of echo-sounders such as Garmin that transmits the data in NMEA format.</li></ul>
<b>Model</b>	Model of the echo sounder <ul style="list-style-type: none"><li><b>NMEA 0183 format</b> Details of the format</li></ul>

#### Device page

Field	Description
<b>Device</b>	Name of the Bluetooth to connect. To start a search in case the instrument is not in the list, hit  and then  .

## 9.6

### Creating a Profile for Cable Detector

#### Creating a profile for cable detector step-by-step

Create one or more profiles related to cable detectors.

Acquire positions with GPS and depth with a cable detector.

Step	Description
1.	Tap <b>Settings</b> .
2.	Tap <b>Cable detector</b> .
3.	Click  .



Parameters and options are organised in pages.

#### Profile page

Field	Description
<b>Profile name</b>	Name to assign to the profile

Field	Description
Brand	Brand of the cable detector
Model	Model of the cable detector

#### Device page

Field	Description
Device	Name of the Bluetooth to connect. To start a search in case the instrument is not in the list, hit  and then  .

# 10

# GPS

## 10.1



## Status

### Description

For instruments with an active rover GPS or base GPS profile, general status of the GPS receiver can be displayed at any moment. Parameters of operation can be modified. The displayed information includes position, quality of the signal, number and position of satellites, information about the base and the position in a Google map.

The displayed information includes position, quality of the signal, number and position of satellites, information about the base and the position in a Google map.







### Access to a GPS status window

Step	Description
1.	<ul style="list-style-type: none"> <li>For a rover GPS: Click  on the toolbar in the main menu.</li> <li>For a base GPS: Click  on the toolbar in the main menu.</li> <li>In survey and stakeout windows: Click the panel </li> </ul>

Parameters and options are organised in pages.

### Quality page

Displays information relative to the quality with which the receiver is working.

Field	Description
<b>RTK position</b>	 <b>RTK Extra-Safe</b> Available for Zenith 35 and Zenith 60. The receiver gets corrections from a source and has fixed the ambiguities in <b>RTK Extra-Safe</b> .
	 <b>RTK Fixed</b> The receiver gets corrections from a source and has fixed the ambiguities with maximum precision.
	 <b>Quick-Fix</b> Available for Zenith 15, Zenith 16, Zenith 25 and Zenith 40. The receiver has fixed the ambiguities but has not reached the maximum precision level yet.
	 <b>RTK Float</b> The receiver gets corrections from a source but it has not yet fixed ambiguities.
	 <b>DGPS</b> The receiver gets differential corrections in DGPS mode.
	 <b>Autonomous</b> The receiver gets positions without receiving corrections from any source in minimum precision.
<b>Precision 2D</b>	Precision of the current position regarding coordinates
<b>Precision Elev</b>	Precision of the current position regarding elevation
<b>RTK Extra-Safe</b>	Available for Zenith 35/Zenith 60. Using extra safe in environments with signal partially blocked allows to have a solution slower getting the fix status but likely less to be erroneous.
<b>Satellites</b>	Number of satellites of the different constellations
<b>HDOP</b>	Horizontal Dilution of Precision

Field	Description
<b>VDOP</b>	Vertical Dilution of Precision
<b>PDOP</b>	General Dilution of Precision related to the satellites position
<b>Age corrections</b>	Delay in receiving corrections in seconds. A high value indicates missing reception of corrections.
<b>GSM Signal</b>	Level of GSM signal
<b>NTRIP Server</b>	Name of the used NTRIP server
<b>Mountpoint</b>	Name of the mountpoint with available access

#### Position page





Field	Description
<b>Geodetic coords</b>	Current latitude, longitude and elevation
<b>Antenna height</b>	Height of the antenna

#### SkyPlot page

Displays position and elevation of the tracked satellites. Click a satellite open a window showing all related information.

#### Satellites page

Displays a list of all tracked satellites including related information.

Icon	Description
	Satellite contributing to the position calculation
	Satellite ignored
	Number of the satellite and constellation
	Number of satellites, for each constellations, used and tracked to calculate the solution.

Field	Description
<b>Position</b>	Indicates the position of the satellite with cardinal points
<b>Elevation</b>	Indicates the elevation of the satellite in the sky
<b>Signal</b>	Signal to noise ratio

#### Base page

Displays information related to the reference base.

Field	Description
<b>Base</b>	Name of the base
<b>Lat., Lon., Elevation</b>	Coordinates of the base
<b>Distance</b>	Distance between base and current position

## Map page

Displays the current position in a Google map or from another provider.



## Tools of the GNSS Status page

From the **GNSS Status** window, edit parameters of the receiver operation.

### Tools

Step	Description
1.	Tap <b>GNSS Status</b> .
2.	Tap  <ul style="list-style-type: none"><li>• <b>Setup receiver</b> Access the profile settings.</li><li>• <b>Start GNSS MOCK Location</b> Set the position of the antenna as position of the controller. All applications requiring the GNSS position of the device receive the position of the GNSS Geomax receiver instead of the position of the receiver inside the device. To use this feature, enable Developer Mode in Android settings.</li></ul>

### Resetting RTK correction

Step	Description
1.	Tap  .
2.	Tap <b>Reset RTK...</b>
3.	The receiver is forced to re-initialise the calculation of the position. RTK received corrections are reset.
	To quickly reset of the RTK corrections and force the receiver to re-initialize the position, double tap for a longer while on the GNSS status.



### Activating and deactivate the use of constellations

Step	Description
1.	Tap  .
2.	Tap <b>Satellites</b> .
3.	Activate and deactivate the use of GLONASS, BeiDou, SBAS.



### Changing cut-off angle

Step	Description
1.	Tap  .
2.	Tap <b>Satellites Cut-off angle</b> .
3.	Modify the minimum elevation above the horizon in degrees to consider satellites usable.

### Connecting and disconnect GPRS

Step	Description
1.	Tap  .
2.	Click <b>Connect GPRS</b> . A GPRS connection starts.
3.	Tap  .
4.	Click <b>Disconnect GPRS</b> . A GPRS connection stops.
	To quickly connect and disconnect, tap for a longer while on the GNSS status.

## Changing mountpoint

Step	Description
1.	Tap  .
2.	Tap <b>Change Mountpoint.</b>
3.	Modify the mountpoint from which to receive RTK corrections through GPRS.  When choosing a mountpoint, the compatibility with the RTCM format in the receiver configuration must be maintained. Example: In the receiver configuration, RTCM2 is set as data format for corrections. Then the selected mountpoint must also transmit corrections in RTCM2 format.  Use the map to view the position of each mountpoint and the distance from them.

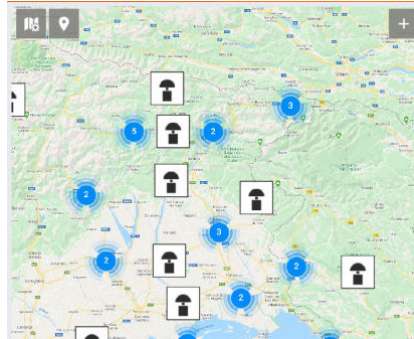

## Reconfiguring the receiver

Step	Description
1.	Tap  .
2.	Tap <b>Configure receiver.</b>
3.	A procedure of complete reconfiguration of the receiver according to current GPS profile starts.

## Editing GPS profile

Step	Description
1.	Tap  .
2.	Tap <b>Receiver.</b>
3.	Review and edit settings of the current GPS profile.

## Managing files

Step	Description
1.	Tap  .
2.	Tap <b>Utilities.</b>
3.	Tap <b>File manager.</b>
4.	Displayed are all files with raw data present in the receiver memory. Select or deselect files to be copied to the controller memory.

## Stopping raw data log

Step	Description
1.	Tap  .
2.	Tap <b>Utilities.</b>

Step	Description
3.	Tap <b>Stop raw data logging</b> .
4.	Stops recording of raw data by receiver.

### Changing radio channel



Step	Description
1.	Tap  .
2.	Tap <b>Utilities</b> .
3.	Tap <b>Change radio channel</b> .
4.	Modify the number of the channel used by the receiver radio.

### Starting NMEA output



Step	Description
1.	Tap  .
2.	Tap <b>Utilities</b> .
3.	Tap <b>NMEA output</b> .
4.	Set the receiver to send NMEA strings to be used by other devices, for example as echosounders or georadar, and by external software. Define the serial port, USB port or Bluetooth port for sending the NMEA strings. Define the frequency. Receiver is configured as requested and X-PAD stops connection with receiver leaving a free communication to software which will have to process the NMEA strings.

### Description of the GPS status panel











All windows with GPS survey and stakeout operations present options either in horizontal or in vertical mode.

Mode	Description
	Horizontal mode
	Vertical mode

Step	Description
1.	Click in the window to access the <b>GNSS Status</b> panel.

Icon	Description
	Current precision for coordinates (H) and for elevation (V).
	Precision level set in the survey parameters has been reached. Epochs are acquired.



Icon	Description
	Precision level set in the survey parameters has not been reached.
	<b>RTK Extra-Safe</b> Available for Zenith 35 and Zenith 60. The receiver gets corrections from a source and has fixed the ambiguities in extra safe mode..
	<b>RTK Fixed</b> The receiver gets corrections from a source and has fixed the ambiguities with maximum precision.
	<b>Quick-Fix</b> Available for Zenith 15, Zenith 16, Zenith 25 and Zenith 40. The receiver has fixed the ambiguities but has not reached the maximum precision level yet.
	<b>RTK Float</b> The receiver gets corrections from a source but it has not yet fixed ambiguities.
	<b>DGPS</b> The receiver gets differential corrections in DGPS mode.
	<b>Autonomous</b> The receiver gets positions without receiving corrections from any source in minimum precision.
	Receiver gets corrections.
	Receiver does not get corrections.
	Number of satellites tracked, for constellations GPS, GLONASS, BeiDou, SBAS.

## 10.2

### Starting a Base

#### Description

Starting a GPS base is a main operation and the first thing to do when working with a couple of receivers. The first receiver (base) remains in a fixed position on the ground and sends corrections through radio to a second receiver (rover). The second receiver is free to move on the ground, according to radio range, measuring or staking out positions.



Receivers can function in base or rover mode using radio or GPRS modem. When using GPRS modem, two SIM cards are required, one for the base and one for the rover. On the base, define a server for **CSD (Direct call)** with direct call in the GNSS profile. On the rover, define the number of the SIM card of the base in the **CSD (Direct call)**.



Commands allowing to start a base are only available when a GPS instrument profile is defined.

If the current profile is related to a GPS receiver defined as base, the software presents only two menus:



- **JOB** menu allowing to manage current job data
- **Start base** menu to operate the base

### Starting a base on a known position step-by-step

Use this mode when the base is positioned on a position with known geographic coordinates. If only plane coordinates are available, define the coordinate system that allows to calculate the geographic coordinates.

Step	Description
1.	Tap <b>Start Base</b> .
2.	Tap <b>Known position</b> .
3.	Make the required settings.
4.	Hit  . Completes the programming of the base and starts the operation. In this phase, the receiver acquires the current position and checks that the difference between current position and position inserted is shorter than 5 seconds.
5.	A list of available GPS rover profiles is created. Select the rover profile with which you want to proceed with the job. The selected profile becomes automatically the current instrument profile.

Field	Description
<b>Base ID</b>	Enter the name of the base. The name of the base is displayed on the rover. The rover can be set so that it only accepts corrections coming from the base with a certain ID.
<b>Code</b>	Code to assign to the point that is created in correspondence of the position of the base.
<b>Antenna height</b>	Measures the antenna elevation from the Antenna Reference Point (ARP) to the ground
<b>Post-Processing data</b>	Activate the recording of raw data on the base. Recorded raw data can be used for data post-processing.
<b>Log data for Post-Processing</b>	Frequency for recording raw data
<b>File for PP</b>	Name of file where to save raw data
<b>File type</b>	Define the kind of file to store.
<b>Reference point</b>	Assign coordinates to base with one of the options: <ul style="list-style-type: none"> <li>Select a point from a table, from a graphic or enter a point. Coordinates of the point are displayed.</li> <li>Enter the geographic coordinates of the base</li> <li>Enter the plane coordinates of the base</li> </ul> In every case, if only plane coordinates are available, define a coordinate system first so that the corresponding geographic coordinates can be calculated.
<b>Create local system on base</b>	Create, simultaneously to configuring the base, a local coordinate system on one point having just the base as reference point. If the option is activated, the local coordinates can be specified to the position of the base.

Icon	Description
	Enter plane coordinates and elevation of the point.
	Enter geographical coordinates and ellipsoidal height of the point.

### Starting a base on current position step-by-step

Use this mode when the base is positioned in a place of which coordinates are not known. The base is started with the approximate position of the receiver.

Step	Description
1.	Tap <b>Start base</b> .
2.	Tap <b>Current position</b> .
3.	The meaning of the fields and the steps to execute are identical with <a href="#">Starting a base on a known position step-by-step</a> .

Step	Description
4.	Click <b>Measure Here</b> to specify the coordinates of the base. Choose one of the following options: <ul style="list-style-type: none"> <li>• <b>Get approximate position</b> Store the approximate position of the receiver.</li> <li>• <b>Get RTK position from NTRIP</b> If a GPRS RTK profile is used, accurate positions of the base are obtained. The current position of receiver is displayed.</li> </ul>

### Starting a base with previous settings step-by-step

Repeat the configuration of the base using previous data.

Step	Description
1.	Tap <b>Start base</b> .
2.	Tap <b>Previous station</b> .
3.	A guided procedure shows coordinates that are assigned to the base and then proceeds with the configuration.

### Start a base with automatic (RTK position) settings step-by-step

Use this mode when the base is positioned in a place of which coordinates are not known.

To use this mode, configure an RTK NTRIP profile. The software configures the receiver in GPS RTK – NTRIP mode to determine the base position. After acquiring the precise position, the receiver is started as a base with the mode “known position”.

Step	Description
1.	Tap <b>Start base</b> .
2.	Tap <b>Automatic (RTK position)</b> .
3.	The meaning of the fields and the steps to execute are identical with <a href="#">Starting a base on a known position step-by-step</a> .
4.	Click <b>Measure Here</b> to specify the coordinates of the base. Choose one of the following options: <ul style="list-style-type: none"> <li>• <b>Get approximate position</b> Store the approximate position of the receiver.</li> <li>• <b>Get RTK position from NTRIP</b> If a GPRSRTK profile is used, accurate positions of the base are obtained. The current position of receiver is displayed.</li> </ul>
5.	Tap  . Tap <b>Search closest ref.point</b> . Choose the coordinates of the reference point closest to the receiver position as the known base position. If there is more than one base reference point on a work site, it is not necessary to remember the name of the reference point, because the program automatically shows the correct one based on the antenna position.

# 11

## Survey of Points - GPS and TPS Common Functions

### Description

This chapter explains some commands and functions that are available in point survey with GPS and total stations.





### 11.1







### Display Mode

### Description

Set the display mode of the graphical window by clicking one of the buttons that show the active display mode.

#### Buttons

Button	Description
	Enables 2D drawing display.
	Enables 3D drawing display.
	Enables 2D display of a reference map.
	The icon notifies that the drawing extension is too large to display all elements appropriately and allows you to define the working area.

Icon	Description
	GPS direction Enables the automatic update of the view oriented to the direction of the antenna.
	TPS direction Enables the automatic update of the view oriented to the direction of the instrument.
	GPS North Enables the automatic update of the view oriented to North
	TPS North Enables the automatic update of the view oriented to North
	Disables the automatic update of the view
	Notifies that the compass of the controller is not calibrated and it is required to perform the calibration procedure.



### Using maps step-by-step

X-PAD allows the use of different types of maps as references for the survey and stakeout activities. All data are displayed as overlap to a map.

Select between Google maps, Bing, OpenStreet, TIFF, GeoTIFF raster map and others.

GeoTIFF includes the parameters for the positioning and sizing of the image map. When a GeoTIFF raster map is imported, it is displayed in the right position and with the right scale.



On the main maps, overlap the Web Map Service (WMS) maps, provided by government agencies or other offices, that represent more elements typical of the area and interesting for the surveying activities.

Step	Description
1.	Tap  .
2.	Tap  .

### Select maps for visualisation

Step	Description
1.	Tap  <ul style="list-style-type: none"><li>• <b>On-line maps</b> page A list of available maps. Choose the desired map or choose <b>None</b> if you want no main map but only WMS maps.</li><li>• <b>On-line WMS</b> A list of WMS maps defined. More than one WMS map can be displayed.</li></ul>

### Web Map Server maps (WMS)

Step	Description
1.	Tap  .
2.	Click <b>On-line WMS</b> .
3.	Tap  <ul style="list-style-type: none"><li>• <b>Name</b> Name to assign to the WMS map.</li><li>• <b>Url</b> Address of the WMS map</li><li>• <b>User</b> User name for accessing the WMS service, if necessary</li><li>• <b>Password</b> Password for accessing the WMS service, if necessary</li><li>• <b>Layer</b> Select the layer to visualise among the ones available in the server</li><li>• <b>Projection</b> Projection used by the WMS service</li></ul>

### Creating maps to use in off-line mode

Step	Description
1.	Make the reference map and eventually the WMS maps visible before proceeding to save an off-line map.
2.	Select <b>Data</b> .
3.	Select <b>Save off-line map</b> .
4.	Save the map.

Step	Description
5.	<p>Set the view in order to include the zone you are interested in, to save for off-line mode use.</p> <ul style="list-style-type: none"> <li>• <b>Map name</b> Name for the off-line map</li> <li>• <b>Zoom Min.</b> Minimum zoom level</li> <li>• <b>Zoom Max.</b> Maximum zoom level</li> <li>• <b>Tiles count</b> Based on the limits of the zone and of the zoom, the number of tiles to be downloaded is calculated.</li> </ul> <p> The number of tiles can be great and request much time to complete downloading and take up much space on the disk. It is recommended to not exceed in the extension of the required zone and to save only the necessary levels of zoom.</p>
6.	When the download of all tiles is finished, the off-line map is available and can be used.

### Using off-line mode maps

Step	Description
1.	Tap  .
2.	Click <b>Use off-line maps.</b>
3.	Select one of the available off-line maps for display.

### Saving the current view as image

Step	Description
1.	Tap  .
2.	Click <b>Save screenshot.</b>
3.	Current view is saved as image file.

### Augmented reality

Step	Description
1.	Tap  .
2.	Click <b>Camera (AR).</b>

Step	Description
------	-------------

- The photo camera of the device is activated. Based on the GPS position, the parameters of the inclination and the direction of the device, the image from camera is shown on the map as overlap.



## 11.2

### Compass Calibration on Controller

#### Controller compass calibration step-by-step

Step	Description
------	-------------

- The software notifies that the controller compass is not calibrated. Tap .
- Perform the calibration procedure by the movement showed in the following image.



The compass is used in the display to indicate the position of the North.

## 11.3

### Electronic Bubble

#### Description

Sensors inside the controller provide information for an electronic bubble on the display. This way the operator can keep the attention on the display instead of looking on the bubble on the pole. The acquisition of epochs is stopped when the pole is out of the bubble.

The controller has to be fixed well to the pole, so that there are not movements between the holder of the controller and the pole.

#### Activation of the electronic bubble step-by-step

Step	Description	
	GPS	TPS
1.	Click <b>Settings</b> .	Click <b>Settings</b> .
2.	Click <b>GNSS</b> .	Click <b>TPS Survey</b> .
3.	Click <b>GNSS Accuracy check</b> .	-
4.	Click <b>E-bubble (GNSS receiver)</b> .	Click <b>E-Bubble</b> .

Step	Description	
	GPS	TPS
5.	To disable the use of the electronic bubble: Tap electronic bubble and click <b>No sensors</b> .	

### Calibration of the electronic bubble

The calibration is a necessary operation allowing the determination of the controller position referring to the pole.

When a survey or stakeout is started, a window allowing to perform calibration of the electronic bubble is displayed.

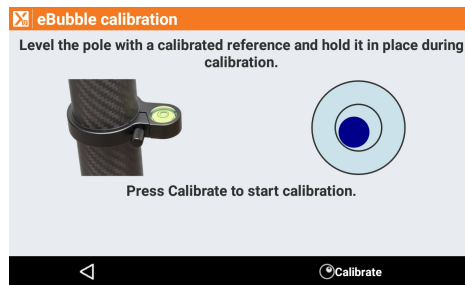

To perform the calibration, use the physical bubble to hold the pole in proper position for some seconds. At the end of the calibration procedure the position of the electronic bubble displayed in the survey and stakeout windows corresponds to the position of the physical bubble. If the calibration procedure has been previously performed, and the controller does not change position referring to the pole, the procedure can be skipped and pass to next window.

## 11.4

### Survey Code Assignment

#### Description

Assign survey codes to a point in different ways:

- Manual insertion of code
- Selection from a table of codes

#### Manual insertion of code step-by-step

Step	Description
1.	Type code directly in the field <b>Code</b> .

#### Selecting from a table of codes step-by-step

Step	Description
1.	Tap <b>&gt;</b> to access to window allowing to select codes.
2.	On the <b>List</b> page, the survey codes are displayed. Select a code from the list.

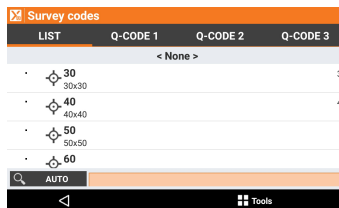



3.	The input field located in the lower part allows to perform a search among codes.
4.	The button on the left allows to specify a search: <ul style="list-style-type: none"> <li>• <b>AUTO</b> Codes and descriptions are considered.</li> <li>• <b>CODE</b> Only codes are considered.</li> <li>• <b>DESC</b> Only descriptions are considered.</li> </ul>

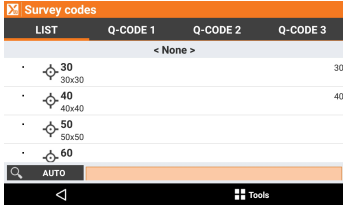

Step	Description
5.	Codes can be listed in alphabetical order or according to use. Tap  . <ul style="list-style-type: none"> <li>• <b>Sort Alphabetic</b></li> <li>• <b>Sort Last used</b></li> </ul> Recently used codes are displayed on top of the list.

### Edit a code during surveying step-by-step

Step	Description
1.	Tap  to access to window allowing to select codes.
2.	On the <b>List</b> page, the survey codes are displayed. Select a code from the list.
	
3.	Tap  .
4.	Click <b>Modify code</b> .
5.	Select a code.
6.	Click <b>Edit</b> .
7.	Make the modifications.
8.	Hit  .

## 11.5

### Quick Codes

#### Description

Quick Codes are a selection of the codes in the list that can be grouped according to needs into one or more pages. This allows for faster access to the desired survey code.

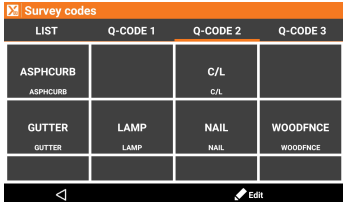

#### Selecting quick codes step-by-step

Step	Description
1.	Tap  to access to window allowing to select codes.
2.	On the <b>Q-Code 1</b> , <b>Q-Code 2</b> , <b>Q-Code 3</b> page, some buttons corresponding to some codes are available. Select the code hitting the corresponding button.
	





In the survey settings an option can be activated that starts automatically the measurement after selecting a quick code.

#### Customising a quick code step-by-step



Step	Description
1.	Tap  to access to window allowing to select codes.
2.	Select one of the three pages with quick codes.
3.	Tap  .
4.	Click <b>Quick-Codes customization</b> .

Step	Description
5.	Hit a button which has no code assigned. Select the code from the list.
6.	Repeat the operation for all buttons to customise.
7.	Hit  to end the quick code customisation mode.



#### Adding quick code page step-by-step

Step	Description
1.	Tap  to access to window allowing to select codes.
2.	Tap  .
3.	Click <b>Add Quick-Codes page</b> .
4.	Hit a button which has no code assigned. Select the code from the list.
5.	Insert the name of the page.
6.	Click <b>OK</b> .

#### Renaming a quick code page step-by-step

Step	Description
1.	Tap  to access to window allowing to select codes.
2.	Tap  .
3.	Click <b>Rename current page</b> .
4.	Rename the current quick code page.

#### Deleting a quick code page step-by-step

Step	Description
1.	Tap  to access to window allowing to select codes.
2.	Tap  .
3.	Click <b>Delete current page</b> .
4.	Delete the current quick code page.

## 11.6

### GIS Features

#### Description

If a GIS feature is associated with a code, a window displays the attributes of the GIS feature that have to be filled in.

The window can be organised in pages, one for every GIS feature, because more than one code can be assigned to a code (composed codes).

On each page, the attributes to be fill in are displayed.

Step	Description
1.	Tap  .
2.	<ul style="list-style-type: none"> <li>Tap <b>From point</b>. Loads values of the attributes saved in one of the points in the job. Select the point from which to load values of the attributes.</li> <li><b>From Prev</b>. Loads values of the attributes save with the previous point.</li> </ul>

## 11.7

### Smart Drawing - Drawing During Survey

#### Description

Generate drawing while measuring points. Two drawing modes are available:

Button	Description
<b>Single lines</b>	Creates a single line between points or draw a circle, rectangles or squared objects.

Button	Description
<b>Multiple lines</b>	Create more lines, even with the same code. For complex survey situations.

Step	Description
1.	Click the lower button of the left side panel in points survey window.

## Single lines

The toolbar of SmartDrawing offers various tools.

Tool	Description
<b>Point</b>	Save single points
<b>Line</b>	Create lines between points
<b>Arc</b>	Create arcs between points
<b>Spline</b>	Create a spline from measured points automatically in <b>SURVEY</b> .
<b>Circle 3P</b>	Create a circle by measuring of three points
<b>Circle C+R</b>	Create a circle by measuring the center and one point on the circle
<b>Square</b>	Create a square by measuring two opposite angles
<b>Square Center</b>	Create a square by measuring the centre point and the middle point of a side
<b>Rectangle base</b>	Create a rectangle by measuring two points of the base and any point on the opposite side from the base
<b>Rectangle center</b>	Create a rectangle by measuring the center, one middle point of a side and any point on opposite side
<b>Break drawing</b>	Break the drawing of the current line
<b>Close</b>	Close the current line to the first point
<b>Reference point</b>	Measures and stores the reference points used daily to setup and orientate the TPS instrument. This is much easier than measuring standard points and then transferring them to the list of reference points.
<b>Control point</b>	Store a point of type <b>Control point</b> .
<b>Select point</b>	Select the requested point on video among the ones still present
<b>Use last point</b>	Use, as requested point, the last saved point

Step	Description
1.	Select a tool from the toolbar.
2.	A button is visualises the request related to the point to measure. Examples:

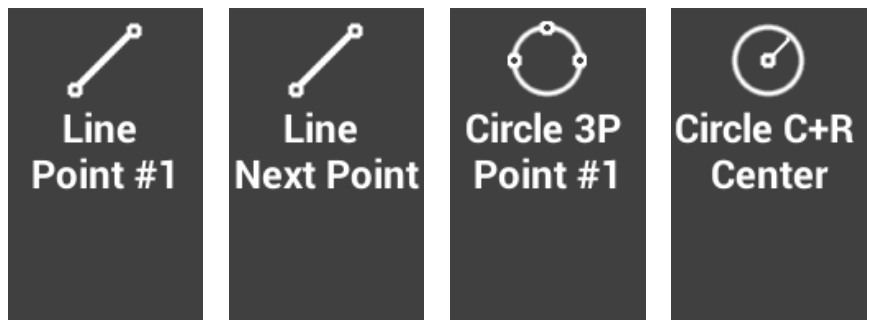

Tap an icon to select an action.

3.	When a survey code is selected, the tool corresponding to the type of drawing set in the code is selected automatically.
----	--

## Multiple lines step-by-step

**Multiple lines** mode allows to generate lines between points based on the code of the point and the number of the line.











Two line types exist:

Type	Description
<b>ACTIVE</b>	Lines currently used in survey and their drawing is not yet completed. Points that form a line are integrated. At the end it becomes a <b>NOT ACTIVE</b> line.
<b>NOT ACTIVE</b>	Lines measured, drawn and completed. Can again become an <b>ACTIVE</b> line in case points must be added.



### Example of job with multiple lines

In a road survey, for example, there are two sides (left and right) and the axis of the road. In this case, it is possible to create two lines with code road side (RS) and a line with code center line (CL). The two lines RS, having the same code, are distinguished by the line number: the first line has number 1 and the second number 2. The codes RS and CL must have as drawing type the attribute **Line**.

Having to do the road survey, operates as follows:

Step	Description
1.	Tap the button <b>Smart drawing</b> to open the control window <b>Smart drawing</b> .
2.	Tap  to open the lines management window.
3.	Tap  to add a line.
4.	Select the code <b>RS</b> corresponding to the road side. The code must be of type <b>Line</b> . The line RS with number 1 is created.
5.	Tap  to add a line.
6.	Select the code <b>CL</b> corresponding to the road axis. The code must be of type <b>Line</b> . The line CL with number 1 is created.
7.	Tap  to add a line.
8.	Select the code <b>RS</b> corresponding to the road side. The code must be of type <b>Line</b> . The line RS with number 2 is created.
9.	Select from the list the line from which to start: <b>RS 1</b>
10.	Tap  to go back to the survey window. The current code is now <b>RS</b> and is reported the line number 1.
11.	Tap  to measure the first point of the road side.
12.	Tap the button <b>Smart drawing</b> to open the control window <b>Smart drawing</b> . The lines management window opens directly.
13.	Select from the list the line of the road axis: <b>CL 1</b>
14.	Tap  to go back to the survey window. The current code is now <b>CL</b> and is reported the line number 1.
15.	Tap  to measure the first point of the road axis.
16.	Tap the button <b>Smart drawing</b> to open the control window <b>Smart drawing</b> . The lines management window opens directly.
17.	Select from the list the second line of the road side: <b>RS 2</b>
18.	Tap  to go back to the survey window. The current code is now <b>RS</b> and is reported the line number 2.
19.	Tap  to measure the first point of the second road side.
20.	Tap  to measure the second point of the second road side. The drawing of the line of the second road side appears in the graphic window.
21.	Continue selecting the line to measure the line management window.

### Adding a line step-by-step



Step	Description
1.	Tap  .
2.	Tap  .

Step	Description
3.	Specify the code to assign to the line. The code must be of type <b>Line</b> . The line number will be the first free number available considering the lines still present with the same code.
4.	Another way to create a new line is to insert the code directly in the points survey window. if the inserted code is of type <b>Line</b> , a line with that code will be automatic created..

#### Select the line to use step-by-step



Step	Description
1.	Tap  .
2.	Select the line, that will be used for the next measure, from the list. Coming back to the survey window, the code of the line is set as current code.
3.	Another way to select a line to use for the next measurement is to select it directly from the graphic window.

#### Duplicating a line step-by-step



Step	Description
1.	Tap  .
2.	Tap  .
3.	Create a line, empty, with the same code as the selected line.
4.	The line number will be the first free number available considering the lines still present with the same code.

#### Ending a line step-by-step

When the drawing of a line is completed, it is not necessary to maintain it in the list of the active lines.



Step	Description
1.	Tap  .
2.	Tap  .
3.	The line is ended and moved to the list of the non active lines.

#### Deleting a line step-by-step

Step	Description
1.	Tap  .
2.	Tap  .
3.	Select the line.
4.	Tap <b>Delete</b> from menu that appears.



#### Inverting a line step-by-step

When a line has been selected, measured points are added always at the end of the line. In some cases it can be necessary to add the points at the beginning of the line. In this case it is necessary to invert the direction of the line before adding new points.

Step	Description
1.	Tap  .
2.	Tap  .
3.	Select the line.
4.	Tap <b>Invert</b> .

#### Closing a line step-by-step

If the drawing of a line must be a closed element, for example for the contour of a building, the line can be closed. The first vertex is joined with the last vertex.

Step	Description
1.	Tap  .
2.	Tap  .
3.	Select the line.
4.	Tap <b>Close</b> .
5.	The line to the list of the non active lines.

### Multi codes for a line step-by-step

In some cases, a measured point belongs to several open lines.

Step	Description
1.	Tap  .
2.	Tap <b>Multi codes</b> .
3.	Select the lines to which the measured point must be added. the point is added to all selected lines as new vertex.

### Automatic coding of a line step-by-step

Automatic coding speeds up the surveying phases where elements to measure occur regularly. This is for example the case in a road survey where the side elements and the axis must be measured.

For these cases, define a list of lines to measure in the correct order and activate the **Zig-Zag** mode or **Same direction** mode. When one of these modes is active, it is no more necessary to select the line to draw but the system suggests the line automatically based on the defined order.

Step	Description
1.	Tap  . <ul style="list-style-type: none"> <li>• <b>Zig-Zag.</b> Survey must be executed from left to right and then from right to left and then again from left to right.</li> <li>• <b>Same direction.</b> Survey must be executed always from left to right or always from right to left.</li> </ul>
2.	The code of the first line in the list is suggested.
3.	Measure the first point.
4.	The code of the second line in the list is suggested.
5.	Continue the procedure.
6.	To stop the sequence, skip a code and pass to the next.
7.	Or pause the system because before proceeding it is necessary to measure other single points not included in the sequence.

## 11.8

### Average Coordinates

#### Description

A point can be measured more than one time and at different times. While measuring, when the name is assigned to the point, define how to proceed:

Option	Description
<b>Overwrite point</b>	The previous point is deleted and a new point is created with the same name.
<b>Additional measure</b>	A new measurement for the point is saved. If the option <b>Average coords</b> has been set in the survey settings, the coordinates of the point are recalculated considering all measurements performed.
<b>Next point:</b>	Suggested is the name of the next point not yet saved.

## 11.9

### Tools and Utilities

#### Tools of survey

In the survey window, different tools and functions are available that can be very useful during measuring operations.

### Editing last point

Step	Description
1.	Tap  .
2.	Tap <b>Edit last point</b> .
3.	Edit the last point measured.

### Deleting last point

Step	Description
1.	Tap <b>Settings</b> .
2.	Tap <b>Delete last point</b> .
3.	Delete the last point measured.

### Sharing last point

Step	Description
1.	Tap <b>Settings</b> .
2.	Tap <b>Share last point</b> .
3.	Select the sharing method and complete the procedure.
4.	For the selected point information related to coordinates (geographic and plane), the code, the description and the eventual photo/sketch associated is sent.

### Adding a note

Step	Description
1.	Tap <b>Settings</b> .
2.	Tap <b>Add note</b> .
3.	Add to the fieldbook: <ul style="list-style-type: none"><li>• Measurements</li><li>• Descriptive notes</li><li>• Sketches that can be a valid reference at the moment of elaborating the measured data in the office</li></ul>

### Points and measurements

During the survey operations it can be useful to access the table of points the fieldbook of measurements to check data and eventually correct some wrong values of antenna elevation, code and description.

Step	Description
1.	Tap <b>Settings</b> .
2.	Tap <b>Points &amp; Measurements</b> .
3.	For further information refer to <a href="#">6 Points, Measurements, Survey Codes and GIS Features Management</a> .

**Description**

The X-Pole solution allows working simultaneously with TPS and GNSS using the best features of each system as required and with maximum flexibility.

The TPS can be oriented directly using the GNSS position acquired simultaneously with the measurement of the prism. It is not necessary to measure points with GNSS first and then measure the same points again with TPS. The operation can be performed at the same time with greater speed and accuracy.

A single click changes the measurement mode and switches from GNSS to TPS mode and vice versa. The change of system is hardly noticeable, since only the panel changes to the current instrument.

The GNSS system positioned above the prism allows a direct rotation on the prism direction speeding lock operations of the prism after loss. With GNSS initialised, the TPS rotates to the exact position of the prism and locks is immediately without any search. With a GNSS position not initialised, the TPS rotates to the approximate position and starts the search for the prism in the surrounding area. In both cases, the locking speed of the prism is greater than the traditional search.







**Using X-Pole in the station setup**

The X-Pole system is particularly useful in station setup because the position provided by the GPS mounted on the pole can be used. This way, the station is oriented and located in the same reference system used by the GPS receiver.

**Free station**

Station setup with free station requires the measurement of points with known coordinates. With X-Pole, the points with known coordinates are provided by GPS.

While measuring points for calculation of the free station, specify the point of known coordinates.

Step	Description
1.	Open the menu and select <b>Measure</b> to proceed with measuring with GPS.
	<p><b>Select point</b></p> <ul style="list-style-type: none"> <li> Traverse points</li> <li> CAD</li> <li> Topographic Points</li> <li> Reference Points</li> <li> Measure</li> <li> Add point</li> </ul> <p style="text-align: right; color: orange;">CANCEL</p>
2.	Measure the point for the free station with the GPS receiver.
3.	The point is added in the list of points and becomes the requested known point.
4.	Measure the same point with total station and complete the measuring procedure of the known point for calculating the station orientation.







**Backsight point**

Station setup with backsight point requires the measurement of points with known coordinates. With X-Pole, the point position is provided by GPS.

Specify the point of known coordinates:

Step	Description
1.	Open the menu and select <b>Measure</b> to proceed with measuring with GPS.









Step	Description
	<p><b>Select point</b></p> <ul style="list-style-type: none"> <li> Traverse points</li> <hr/> <li> CAD</li> <hr/> <li> Topographic Points</li> <hr/> <li> Reference Points</li> <hr/> <li> Measure</li> <hr/> <li> Add point</li> </ul> <p style="text-align: right; color: orange;">CANCEL</p>
2.	Measure the backsight point with the GPS receiver.
3.	The point is added in the list of points and becomes the requested known point.
4.	Measure the same point with total station and complete the measuring procedure of the known point for calculating the station orientation.

### Using X-Pole in site calibration

X-Pole system can be used to calculate the site calibration using positions measured with total station. This way you can use GPS in the same reference system established with total station.

Site calibration requires the measurement of a point with GPS with known plane coordinates. The coordinates can be the result of a measurement with the total station.

When requested to indicate the point of known coordinates:

Step	Description
1.	Open the menu and select <b>Measure</b> to proceed with measuring with TPS.
	<p><b>Select point</b></p> <ul style="list-style-type: none"> <li> Traverse points</li> <hr/> <li> CAD</li> <hr/> <li> Topographic Points</li> <hr/> <li> Reference Points</li> <hr/> <li> Measure</li> <hr/> <li> Add point</li> </ul> <p style="text-align: right; color: orange;">CANCEL</p>
2.	Measure the point with TPS.
3.	The point is added in the list of points and becomes the requested point to proceed with GPS site calibration.

### Using X-Pole during survey



X-Pole system is available in points survey windows. In the upper part of the window a button allows to switch to the other survey mode.



In the TPS survey window, it is possible to switch to GPS survey.



In the GPS survey window, it is possible to switch to TPS survey.

Icon	Description
	From GPS survey mode switch to total station survey mode. The target height is automatic adapted.
	From total station survey mode you pass to GPS survey mode. The pole height is automatic adapted.

## Pole height

X-Pole system requires the installation of the GPS receiver over the prism. The height of the GPS receiver is then height of the pole plus the distance between the center of the prism and the reference point of the receiver.

When starting X-Pole system, the pole height of the receiver is automatically managed keeping in consideration the offset between center of the prism and receiver.

When you modify the pole height, a window appears allowing to specify the correct height to avoid errors.

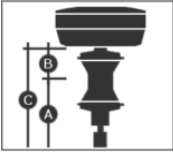

**Antenna height**

<b>Type</b>	X•Pole (59mm) <span style="float: right;">▼</span>
<b>Pole (A)</b>	1.859m
<b>Offset (B)</b>	0.059m
<b>Antenna (C)</b>	1.918m



## Search prism from GPS position

When X-Pole system is functioning it enables the automatic prism research using the position provided by the GPS receiver. When the prism is lost, the software uses the position provide by GPS to turn the station in the direction of the prism to support automatic locking. The manual mode can also be used to call the station toward prism (knowing the GPS receiver position).

Step	Description
1.	Tap  .
2.	Tap  .

# 13

## GPS - Survey of Points

### Description

This chapter explains commands allowing measuring of points with GPS instruments. Different operative modes are explained.



Commands for measuring points are available when the GPS instrument is in rover mode.

### 13.1

### Survey of Points

### Description

The procedure allows to measure and record the position of points, even when a point cannot be measured directly.

Step	Description
1.	Tap <b>SURVEY</b> .
2.	Tap <b>Survey points</b> .

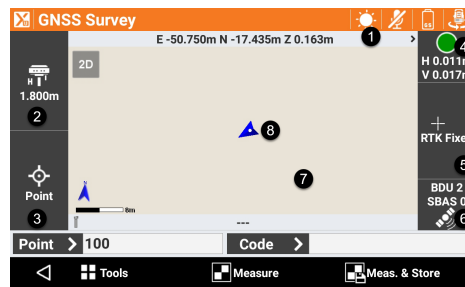



Refer to the table below for an explanation of the legend numbers.

The toolbar at the bottom provides access to a menu of advanced functions and to commands for measuring points.

The required data for recording points is:

- **Point**  
Name of the point to measure
- **Code**  
Code to assign to the point to measure

Legend	Type	Description
1.	Coordinates	The geographic coordinates (latitude, longitude, elevation) of the receiver. Click to display the plane coordinates (East, North, elevation). Click again to switch back to the geographic coordinates.
2.	Antenna elevation	Elevation of the antenna of the receiver. Click to modify the elevation.
3.	Smart Drawing - Drawing during survey	Displays the current status of the function Smart Drawing. Click to select a tool for drawing or the operation to perform. Refer to <a href="#">11.7 Smart Drawing - Drawing During Survey</a> .
4.	Accuracy	The colour of the icons,  or  , indicates if the precision level set in the survey parameters, has been reached. The epochs are acquired only when the level of precision has been reached (horizontal and vertical precision, minimum number of satellites, maximum values of DOP, electronic bubble). Below the icon, the current precision values for coordinates (H) and for elevations (V) is displayed.

5. Receiver status



Click to access the **GNSS Status** window.



#### RTK Extra-Safe

Available for Zenith 35 and Zenith 60. The receiver gets corrections from a source and has fixed the ambiguities in **RTK Extra-Safe**.



#### RTK Fixed

The receiver gets corrections from a source and has fixed the ambiguities with maximum precision.

Legend	Type	Description
		<b>Quick-Fix</b> Available for Zenith 15, Zenith 16, Zenith 25 and Zenith 40. The receiver has fixed the ambiguities but has not reached the maximum precision level yet.
		<b>RTK Float</b> The receiver gets corrections from a source but it has not yet fixed ambiguities.
		<b>DGPS</b> The receiver gets differential corrections in DGPS mode.
		<b>Autonomous</b> The receiver gets positions without receiving corrections from any source in minimum precision.
6.	Satellites	Number of satellites tracked, for constellations GPS, GLONASS, BeiDou, SBAS.
7.	Graphic area	Graphic view with visualisation of survey and drawing. Click twice in the graphic part to access the main CAD window.
8.	Current position	Indicates the current position. Blue: All parameters of operation satisfy the preset level of accuracy. Red: The accuracy parameters are not met.

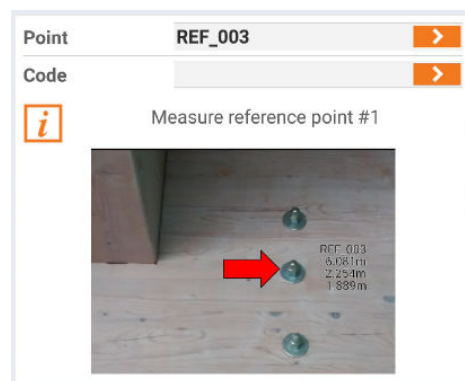



For the GNSS localisation, it is required to measure one or more reference points. If a reference point has been stored with a photo, the photo is displayed as an aid to identify and measure the correct point.

### Rapid measuring of points step-by-step

Step	Description
1.	Tap
2.	The acquisition of positions for the number of epochs set in survey parameters starts. The epochs are acquired if the conditions defined for <b>Accuracy check</b> are met. Refer to <a href="#">Accuracy check step-by-step</a> . Otherwise the software keeps waiting for a manual stop or until the conditions are met.
3.	Tap  to stop measuring when the configured conditions are not satisfied, and to record the point anyway.
4.	When the number of defined epochs is reached, the point is saved. The name of next point is automatically suggested.

## Measuring points step-by-step







Step	Description
5.	If GIS feature are required for a point code, a window for entering the attributes opens.

Step	Description
1.	Tap  .
2.	The acquisition of positions for the number of epochs set in survey parameters starts. The epochs are acquired if the conditions defined for <b>Accuracy check</b> are met. Refer to <a href="#">Accuracy check step-by-step</a> . Otherwise the software keeps waiting for a manual stop or until the conditions are met.
3.	Tap  to stop measuring.
4.	When the number of defined epochs is reached, confirm the data on the pages listed below this table.
5.	If GIS feature are required for a point code, a window for entering the attributes opens.

### Data page

Field	Description
<b>Point</b>	Name of the point to store
<b>Antenna height</b>	Elevation of the antenna at the moment of the acquisition of the point
<b>Code</b>	Code assigned to the point. Refer to <a href="#">11.4 Survey Code Assignment</a> and <a href="#">11.5 Quick Codes</a> .
<b>Description</b>	Extended description associated to the point

### Sketch page



Icon	Description
	Deletes sketch and photo.
	Restores original content
	Adds a label with main information of the point. The label can be moved in every position.
	Adds a label with a free text. The label can be moved in every position.
	Adds an arrow symbol. The arrow can be moved and turned.
	Enables the free drawing mode.
	Starts the application allowing to shoot a photo and save it.

## Result page

General information about the point to record.



### Accuracy check step-by-step

Step	Description
1.	Tap  .
2.	Tap <b>Survey settings</b> .
3.	Tap <b>GNSS</b> page.
4.	Tap <b>GNSS Accuracy check</b> .

Field	Description
<b>Store only in Fixed</b>	The epochs recording is done only if the receiver is in fixed position.
<b>Accuracy check</b>	Activates accuracy check. GPS epoch is accepted if the current precision satisfies the preset precision conditions.
<b>H</b>	Maximum horizontal precision for an acceptable GPSEpoch.
<b>V</b>	Maximum vertical precision for an acceptable GPSEpoch.
<b>RTK age check</b>	Enables control of receiving corrections. When activated, corrections must be received within the time set to store the point.
<b>Max age (secs)</b>	Sets the maximum time that the new RTK fix needs to be received.
<b>DOP check</b>	Activates the check on DOP value. The GPS epoch is accepted if the DOP value is lower than the preset one.
<b>Max DOP</b>	Maximum DOP value to make acceptable the GPS epoch.
<b>Satellites check</b>	Activates the number of satellites checked. The GPS epoch is accepted if the number of tracked satellites is more than the minimum value preset.
<b>Min Satellites</b>	Minimum number of satellites required for an acceptable GPS epoch.
<b>Sensors mode</b>	It is possible to set the use of different types of sensors in surveying and stakeout phases: <ul style="list-style-type: none"><li>• <b>None:</b> No sensor</li><li>• <b>E-Bubble (X-TILT)</b> Activates the use of an electronic bubble of the controller. The GPS epoch is accepted if the electronic bubble is inside the tolerance range.</li><li>• <b>E-bubble (GNSS receiver)</b> Available for Zenith 35 TAG and Zenith 60. Activates the use of an electronic bubble of the GPS receiver (if present). The GPS epoch is accepted if the electronic bubble is inside the tolerance range.</li><li>• <b>Tilted pole (GNSS receiver)</b> Available for Zenith 35 TAG and Zenith 60 (using the internal IMU). Activates the use of tilt and compass sensors of the GPS receiver (if present). Sensors allow to calculate the position of the point even if the pole is not vertical.</li></ul>
<b>Max error (2m pole)</b>	Maximum error acceptable outside the bubble considering a 2 metre pole.
<b>Localization area check</b>	Activates the GPS localisation zone check. If a coordinate system defined by a localisation with more than two points is set, the software verifies if the receiver position is inside the localisation zone. If the current position is outside of the localisation zone, an icon is displayed on the coordinates panel in survey and stakeout windows.  <b>N 45°57'09.5371" E 12°29'40.3363" 71.451m</b>  The localisation zone is drawn in the graphic window.

### Recording of raw data during survey step-by-step

In cases where an own base is unavailable or where it is impossible to connect to a network of permanent stations, record all survey session data in a file with proprietary format RINEX format. Post-process the data in the office to obtain precise coordinates for the base.

Step	Description
1.	Tap  .
2.	Tap <b>Start log</b> . The recording of raw data on receiver starts. The measured points with all the kinematic chains are to a file created by the receiver.
3.	In a window, define some parameters necessary to memorise the data of the session. Such requests can be different based on the receiver model. <ul style="list-style-type: none"> <li>• <b>Log file</b> Name of the file where the raw data are stored</li> <li>• <b>Occup.time</b> Time of acquisition of single point</li> <li>• <b>Logging rate</b> Frequency of the data recording for post-processing</li> <li>• <b>File type</b> Sets the file's type to store</li> <li>• <b>Antenna height</b> Sets the height of antenna to store.</li> </ul>
4.	Recording of raw data is stops automatically when the survey of points procedure ends or it can be interrupted at any moment. Tap  .
5.	Tap <b>Stop log</b> .
6.	Transfer the file of the receiver to a computer for post-processing with a dedicated software. post-processing provides the compensated coordinates.

### Measuring points with X-Tilt for GPS

The GPS receiver has sensors allowing to acquire points with two new modes unavailable on traditional receivers.

Field	Description
<b>E-Bubble (X-TILT)</b>	Exploiting the internal inclinometer, an electronic bubble is displayed directly on the screen. The operator can keep the attention on the display instead of constantly looking at the controller and the physical bubble placed on the pole. Moreover, the software is able to prevent the acquisition of the epochs when the pole is located outside the bubble condition.

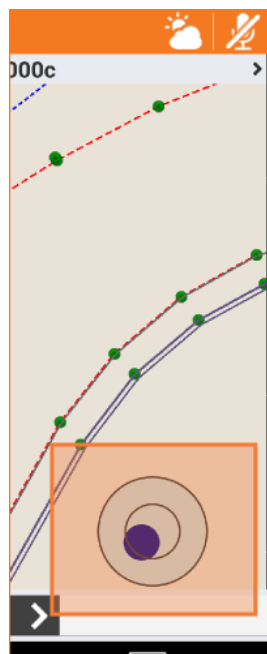

Field	Description
<b>Dual</b>	Exploiting the internal inclinometer, a double measurement of the point with inclined pole (up to and beyond 30°) can be done and determine the position of the point. This mode requires no system calibration and is not sensitive to external factors. The measurement of points runs automatically.
<b>Single</b>	<p>For Zenith 35: Exploiting the internal inclinometer and the internal compass the system is able to determine the three-dimensional position and direction of the pole and to calculate the coordinates of the point on the ground even when the pole is inclined (up to 15 °). The system requires the compass calibration and may be subject to external factors such as magnetic fields generated by the elements present on the site to be surveyed. For more information on the calibration mode and the operating procedures to be followed in the field, see the documentation supplied with the receiver. To measure points with <b>Single mode</b>, activate the <b>Tilted pole (GNSS receiver)</b> option. Refer to <a href="#">Accuracy check step-by-step</a>. Before using this mode it is necessary that a calibration of the internal compass has been executed.</p> <p>For Zenith 60: The system uses the internal IMU. The system determines the three-dimensional position and direction of the pole to calculate the coordinates of the point on the ground even when the pole is inclined (up to 60 °). The system does not require a calibration and is not subject to external factors such as magnetic fields generated by the elements present on the site to be surveyed. For more information on the calibration mode and the operating procedures to be followed in the field, see the documentation supplied with the receiver. To measure points with <b>Single mode</b>, activate the <b>Tilted pole (GNSS receiver)</b> option. Refer to <a href="#">Accuracy check step-by-step</a>.</p>

#### Electronic bubble

Step	Description
1.	Tap  .
2.	Tap <b>Survey settings</b> .
3.	Tap <b>GNSS</b> page.
4.	Tap <b>GNSS Accuracy check</b> .
5.	For <b>Sensors mode</b> , select <b>E-bubble (GNSS receiver)</b> .
6.	In the survey and stakeout windows, the bubble is displayed. During the phases of acquisition of the position, if the inclination of the pole is higher than the set tolerance, the position is not acquired.
7.	Click the electronic bubble, to disable the use of the bubble, enable the calibration or switch to <b>Tilted pole (GNSS receiver)</b> .

#### Dual mode

This measuring mode allows measuring points without having to keep the pole vertical. It requires two inclined measurements in two directions while keeping the tip of the pole on the point.

The measurement of points runs automatically.

Step	Description
1.	Tap  .
2.	Tap <b>Hidden points</b> .
3.	Tap <b>Tilted pole</b> .



Step	Description
4.	First measurement Place the tip of the pole on the point to measure. Tilt the pole to a position that allows the receiver to fix the position. Do not go beyond 30 to 40°. Stay stable to acquire the first position automatically.
5.	Second measurement Keep the tip of the pole on the point and the pole inclined rotate around the point. A circle appears on the map representing the first measurement and a second circle representing the second measure. Act so that the two circles have an overlapping zone and two points of intersection. Stay stable until the second position is acquired.
6.	Third measurement If necessary or to improve the accuracy of the calculated data, perform a third measure always with the previous modes.
7.	Calculation The intersections of the two circles are calculated. Bring back slightly the pole in a vertical direction to allow the software to automatically select the intersection related to measured point.
	During this procedure it is not necessary to press any button.

### Single mode Zenith 35

Step	Description
1.	Tap  .
2.	Tap <b>Survey settings</b> .
3.	Tap <b>GNSS</b> page.
4.	Tap <b>GNSS Accuracy check</b> .
5.	Select <b>Tilted pole (GNSS receiver)</b> . In the survey and stakeout windows, the bubble is displayed. If the calibration is correct, the calculated position is always the position of the point on the ground at any angle (up to 15°).
6.	Click the electronic bubble, to disable the use of the bubble, enable the calibration or switch to <b>E-Bubble (X-TILT)</b> .

### Single mode Zenith 60

Step	Description
1.	Tap  .
2.	Tap <b>Survey settings</b> .
3.	Tap <b>GNSS</b> page.
4.	Tap <b>GNSS Accuracy check</b> .
5.	Select <b>Tilted pole (GNSS receiver)</b> . In the survey and stakeout windows, the bubble is displayed. The calculated position is always the position of the point on the ground at any angle (up to 30°).
6.	Click the electronic bubble, to disable the use of the bubble, enable the calibration or switch to <b>E-Bubble (X-TILT)</b> .

## 13.2

### Hidden Point

#### Description

Hidden points are positions for which the receiver GPS cannot acquire precise coordinates due to insufficient visibility of satellites. To acquire GPS positions, special features to measure distances and slopes can be applied.





Distances and difference in elevation between reference points and the hidden point can be measured using a laser Disto with Bluetooth. After measuring the distance, press the Bluetooth button on the device. The measured value is displayed in the distance field of the window. If the measurement of the inclination angle is configured, both distance and difference in elevation values are transferred.

To use the laser Disto, a corresponding profile must be configured in the instrument profiles.

### Intersection of two distances step-by-step

Calculates the position of one point or multiple points by two distances to two reference points.



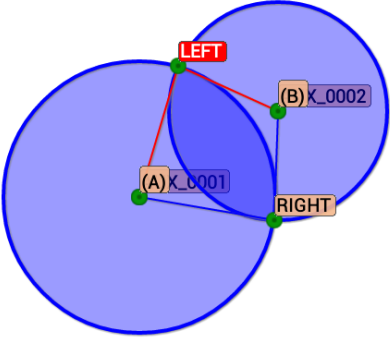



A guided procedure allows the definition of the two reference points, the measurement of distances and the selection of the preferred solution. The requested data relate to the first reference point.

Step	Description
1.	Tap  .
2.	Tap <b>Hidden points</b> .
3.	Tap <b>Distance-Distance</b> .
4.	<p>First point (A)</p> <ul style="list-style-type: none"> <li>• <b>Reference point (A)</b> Specify the name of the first reference point. Type in the name or select it from the graphic window or the table. Tap  if the reference point has not been measured yet.</li> <li>• <b>Distance from A</b> Allows to measure the reference point.</li> <li>• <b>Height diff. from A</b> Elevation difference between the point to measure and the reference point.</li> <li>• <b>Laser height</b> Elevation of the laser Disto from the ground. Used to determinate the exact value of the slope from the reference point.</li> </ul>
5.	<p>Tap <b>Next</b> to proceed with the guided procedure. OR Click <b>Add measured distance</b> to measure the distance to an additional hidden point.</p>
6.	<p>Second point (B)</p> <ul style="list-style-type: none"> <li>• <b>Reference point (B)</b> Specify the name of the second reference point. Type in the name or select it from the graphic window or the table. Tap  if the reference point has not been measured yet.</li> <li>• <b>Distance from B</b> Allows to measure the reference point.</li> <li>• <b>Height diff. from B</b> Elevation difference between the point to measure and the reference point.</li> <li>• <b>Laser height</b> Elevation of the laser Disto from the ground. Used to determinate the exact value of the slope from the reference point.</li> </ul>
7.	Tap <b>Next</b> to calculate the two reference points and the two possible solutions.
8.	<p>Choose the desired solution: Click in the part to which the solution <b>RIGHT</b> or <b>LEFT</b> belongs. The solution that will be used is shown in red.</p> <p> At the moment to choose the solution, approach the receiver toward the point to measure. The position of the receiver is displayed in the graphic window allowing to understand which of the two solutions is the one required.</p>
	 <p>The calculation scheme and the measured point can be visualized also on Google map.</p>
9.	Tap <b>Next</b> to proceed with the guided procedure.
10.	Confirm the data on the pages listed below this table.
11.	Continue to measure other hidden points or return to the main measuring window.

### Data page

Field	Description
<b>Point</b>	Name of the point to store
<b>Antenna height</b>	Elevation of the antenna at the moment of the acquisition of the point
<b>Code</b>	Code assigned to the point. Refer to <a href="#">11.4 Survey Code Assignment</a> and <a href="#">11.5 Quick Codes</a> .
<b>Description</b>	Extended description associated to the point

### Sketch page

Button	Description
	Deletes sketch and photo.
	Restores original content
	Adds a label with main information of the point. The label can be moved in every position.
	Adds a label with a free text. The label can be moved in every position.
	Adds an arrow symbol. The arrow can be moved and turned.
	Enables the free drawing mode.
	Starts the application allowing to shoot a photo and save it.

### Result page



General information about the point to record.

### Alignment and offset step-by-step

Calculates the position of a point by an alignment defined by two reference points.

A guided procedure allows the definition of the two reference points, the measurement of the distance and position referring to the alignment and checking the desired solution. The requested data relate to two reference point.



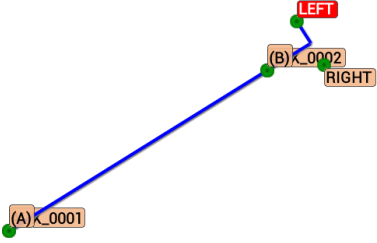



Step	Description
1.	Tap  .
2.	Tap <b>Hidden points</b> .
3.	Tap <b>Alignment Offset</b> .

Step	Description
4.	Reference points <ul style="list-style-type: none"> <li>• <b>Reference point (A)</b> Specify the name of the first reference point. Type in the name or select it from the graphic window or the table. Tap  if the reference point has not been measured yet.</li> <li>• <b>Reference point (B)</b> Specify the name of the second reference point. Type in the name or select it from the graphic window or the table. Tap  if the reference point has not been measured yet.</li> </ul>
5.	Tap <b>Next</b> to proceed with the guided procedure.
6.	Distance & Offset <ul style="list-style-type: none"> <li>• <b>Reference</b> Reference distance along the alignment can be referred to starting point (A) or ending point (B).</li> <li>• <b>Distance from B</b> Distance along the alignment, and referred to point A or B, of the projection of the point to measure.</li> <li>• <b>Offset</b> Distance of the point to measure in reference to the defined alignment. The position of the point referring to the alignment (left or right) is decided after in the graphic window.</li> <li>• <b>Height diff. from B</b> Elevation difference between the point to measure and the reference point A or B.</li> <li>• <b>Laser height</b> Elevation of the laser Disto from the ground. Used to determinate the exact value of the slope from the reference point.</li> </ul>
7.	Tap <b>Next</b> to calculate the two reference points and the two possible solutions. Right or left of the alignment.
8.	Choose the desired solution: Click in the part to which the solution <b>RIGHT</b> or <b>LEFT</b> belongs. The solution that will be used is shown in red. <p> At the moment to choose the solution, approach the receiver toward the point to measure. The position of the receiver is displayed in the graphic window allowing to understand which of the two solutions is the one required.</p>
	
9.	Tap <b>Next</b> to proceed with the guided procedure.
10.	Confirm the data on the pages listed below this table.
11.	Continue to measure other hidden points or return to the main measuring window.

#### Data page

Field	Description
<b>Point</b>	Name of the point to store
<b>Antenna height</b>	Elevation of the antenna at the moment of the acquisition of the point
<b>Code</b>	Code assigned to the point. Refer to <a href="#">11.4 Survey Code Assignment</a> and <a href="#">11.5 Quick Codes</a> .
<b>Description</b>	Extended description associated to the point

### Sketch page

Button	Description
	Deletes sketch and photo.
	Restores original content
	Adds a label with main information of the point. The label can be moved in every position.
	Adds a label with a free text. The label can be moved in every position.
	Adds an arrow symbol. The arrow can be moved and turned.
	Enables the free drawing mode.
	Starts the application allowing to shoot a photo and save it.

### Result page

General information about the point to record.

## 13.3



### Description

#### Automatic survey of points step-by-step

### Automatic Survey of Points

Automatic surveying allows the automatic acquisition of positions of the points based on elapsed distance or elapsed time rules.

Step	Description
1.	Tap <b>SURVEY</b> .
2.	Tap <b>Auto-Survey of points</b> .

Step	Description
3.	<p>Before starting acquisition of points, set the functioning parameters and rules.</p> <ul style="list-style-type: none"> <li>• <b>Mode</b> Mode to use for automatic survey of points <ul style="list-style-type: none"> <li>• <b>Time</b> Position is acquired at preset intervals of time</li> <li>• <b>Distance 2D</b> Position is acquired at preset intervals of horizontal distance</li> <li>• <b>Distance 3D</b> Position is acquired at preset intervals of 3D distance</li> <li>• <b>Distance 2D Plus</b> Position is acquired at preset intervals of horizontal distance and height difference according to settings</li> <li>• <b>Stop &amp; Go</b> Position is acquired when the antenna remains still in a position</li> </ul> </li> <li>• <b>Measure every (sec)</b> Available for <b>Time</b> mode. Set the interval of time between every automatic acquisition of position.</li> <li>• <b>Distance 2D</b> Set the interval of horizontal distance that must be between position to acquire and previously acquired position.</li> <li>• <b>Distance 3D</b> Set the interval of 3D distance that must be between position to acquire and previously acquired position.</li> <li>• <b>Distance 2D Plus</b> Available for <b>Distance 2D Plus</b> mode. Set the interval of horizontal distance that must be between position to acquire and previously acquired position. The point is stored when one of the set values is overpassed.</li> <li>• <b>Height diff.</b> Available for <b>Distance 2D Plus</b> mode. Set the interval of height difference that must be between position to acquire and previously acquired position. The point is stored when one of the set values is overpassed.</li> <li>• <b>Stop time (sec)</b> Available for <b>Stop &amp; Go</b> mode. Defines the time spent on the point to allow the acquisition of the position.</li> <li>• <b>Max antenna movement</b> Available for <b>Stop &amp; Go</b> mode. Maximum movement allowed to consider the antenna still. When the software recognises that the antenna remains almost still with a movement less than maximum value, the acquisition of positions begins for the preset stop time.</li> </ul>
4.	The window functions in the same way of the simple surveying window. Refer to <a href="#">13.1 Survey of Points</a> .
5.	Tap  .
6.	The measuring of points starts automatically. The point number is automatically increased at every recorded point.
7.	Position is acquired if conditions set in <b>Accuracy check</b> are satisfied. Otherwise the software waits for a manual stop or until conditions are reached.
8.	Tap  to stop measuring.
9.	The procedure recognises automatically when conditions for recording are reached evaluating time elapsed or the distance elapsed. When reaching conditions of recording the point is recorded.

## 13.4



### Static Survey of Points

#### Description

Record static data of the position of the receiver for post-processing to determinate precise coordinates.

#### Static survey of points step-by-step

Step	Description
1.	Tap <b>SURVEY</b> .
2.	Tap <b>Static survey</b> .

Step	Description
3.	Define the parameters necessary to execute recording of data of the session by the receiver. <ul style="list-style-type: none"> <li>• <b>Log file</b> Name to assign to the log file that contains data of the occupation.</li> <li>• <b>Logging rate</b> Frequency with which to record data for post-processing.</li> <li>• <b>Occup.time</b> Occupation time of the point. Set a default time or choose the <b>Custom</b> option. In this case, the stop of the point occupation has to be made manually.</li> <li>• <b>Memory type</b> Available on some receiver models. Receiver internal memory or SD card.</li> <li>• <b>File type</b> Sets the file's type to store.</li> <li>• <b>Antenna height</b> Sets the height of antenna to store.</li> </ul>
4.	Tap <b>Next</b> to proceed and go to the window of static measuring of points. The window functions in the same way of the simple surveying window. Refer to <a href="#">13.1 Survey of Points</a> .
5.	Tap  .
6.	The static measuring of the positions starts. Receiver begins data recording inside the controller or in its internal memory.
7.	If the time of occupation has been defined, a counter of the remaining time is displayed. Otherwise a counter shows the time since the beginning of the occupation.
8.	Tap  to stop measuring.
9.	At the end of the occupation or after a stop, the command asks a confirmation of the data of the point.

## 13.5

### Bathymetric Survey

#### Description

Bathymetry is a module of X-PAD Ultimate software that enables bathymetric survey by using an echosounder in combination with a GPS receiver or TPS 360° prism. The software is able to connect to the echosounder through Bluetooth and receive in real-time the depths. At the same time, the accurate positions are given by the GPS receiver or TPS 360° prism placed just over the echosounder. For TPS, the software keeps the prism locked and stores the points in bathymetric sessions continuously.

It is possible to record automatically positions and depth by defining a time interval, a distance or a depth interval. Current depth and the longitudinal profile of the bottom are displayed in real-time through a specific panel.

To be sure to cover the whole area without missing any detail, it is possible to define routes and have all necessary information on the screen to keep the right direction. A route can be a line or a polyline that can be selected on the screen. Another way to define a route is to enter an azimuth value as reference direction to follow. Collected data can be exported in customisable ASCII format or AutoCAD DXF drawing.

#### Bathymetric survey step-by-step

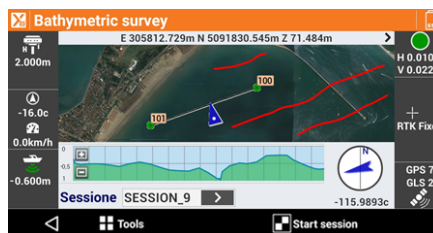

The bathymetric survey acquires continuously the GPS or TPS 360° prism position and depth according to rules of distance or elapsed time. The GPS must be positioned in correspondence of the echosounder.

Step	Description
1.	Tap <b>SURVEY</b> .
2.	Tap <b>Bathymetric survey</b> .

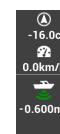

Displayed is:  
On the side: Real-time values of speed, direction and depth



Step	Description
	At the bottom: Contours during the survey
3.	<p>Before starting acquisition of points, set the functioning parameters and rules.</p> <ul style="list-style-type: none"> <li>• <b>Mode</b> Mode to use for automatic survey of points <ul style="list-style-type: none"> <li>• <b>Time</b> Position is acquired at preset intervals of time</li> <li>• <b>Distance 2D</b> Position is acquired at preset intervals of horizontal distance</li> <li>• <b>Depth</b> The position is acquired at fixed intervals of difference in depth</li> </ul> </li> <li>• <b>Single positions</b> The position is acquired manually pressing the <b>Store point</b>.</li> <li>• <b>Route tolerance</b> The acceptable distance from the route. A navigation arrow shows the distance from the route. If the value is exceeded, the software shows the direction to come back to the route.</li> <li>• <b>Measure every (sec)</b> Available for <b>Time</b> mode. Set the interval of time between every automatic acquisition of position.</li> <li>• <b>Measure every (sec)</b> Available for <b>Distance 2D</b> mode. Set the interval of horizontal distance that must be between position to acquire and previously acquired position.</li> <li>• <b>Measure every (sec)</b> Available for <b>Depth</b> mode. Set the depth interval that must between the depth to be acquired and the depth acquired previously.</li> </ul>
4.	<p><b>Session</b> Assign the name to bathymetry session</p>
5.	Tap  <b>Start session</b> to start the session of the bathymetric survey.
6.	Tap  <b>Stop</b> to stop the session of the bathymetric survey.

## Tools of the bathymetric survey

### Setting the fixed route

Step	Description
1.	Tap  .
2.	Tap <b>Route mode</b> .
3.	Tap <b>Fixed direction</b> .
4.	Set a route direction (azimuth) to follow. During the survey, a panel appears that allows to maintain the predetermined route.

### Setting a route from a drawing element



Step	Description
1.	Tap  .
2.	Tap <b>Route mode</b> .
3.	Tap <b>Select route from CAD</b> .
4.	Select a line or a polyline from the graphic window. The selected item becomes the reference element to follow. The panel with the indications of the route shows exactly the direction to be maintained in order to remain in the selected route.

### Cancelling a route

Step	Description
1.	Tap  .
2.	Tap <b>Route mode</b> .
3.	Tap <b>Cancel route</b> .
4.	The selected route is deleted.



### Storing points and measurements

Step	Description
1.	Tap  .
2.	Tap <b>Store points and measurements.</b>
3.	Every point of the bathymetric session is stored as a point and measurement of the survey.
4.	Tap  .
5.	Tap <b>Do not store points and measurements.</b>
6.	Storing of bathymetric session points as points and measurements of the survey is disabled.

### Creating a surface

Step	Description
1.	Tap  .
2.	Tap <b>Create surface.</b>
3.	A surface based on selected sessions is created.

### Adding a note

Step	Description
1.	Tap  .
2.	Tap <b>Add note.</b>
3.	Descriptive notes and sketches that can be a valid reference when processing the stored data in the office can be added during the bathymetric survey operations.

### Defining survey settings

Step	Description
1.	Tap  .
2.	Tap <b>Survey setup.</b>
3.	During survey operation, it is possible to access receiver settings. Refer to <a href="#">5 Settings</a> .

### Visualising survey sessions

Step	Description
1.	Tap  .
2.	Tap <b>Bathymetric session.</b>
3.	A list of the bathymetry sessions executed is displayed. Selecting a session to access additional information or to delete a session.

### Exporting survey sessions

Step	Description
1.	Tap <b>JOB.</b>
2.	Tap <b>Export &amp; Share.</b>
3.	Tap <b>Text file (ASCII).</b>
4.	Tap <b>Bathymetric session.</b>
5.	Data of the bathymetry sessions can be exported in ASCII format.

## 13.6

### Survey with Locators (Cable Detectors)

#### Survey with locators (cable detectors) step-by-step

The methodology of GPS survey with locators is the same as the standard GPS survey. An active locator profile must be defined that is used to acquire the depth values.

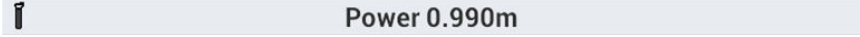
Step	Description
1.	Tap <b>SURVEY</b> .
2.	Tap <b>Survey points</b> .
3.	If the locator profile is active in the GPS survey window, a bar like this appears: 
4.	Press the LOG key of the locator to send the measured value of depth to the software on the controller. The software captures the depth and stores a new point using the current GPS position.

# 14

## GPS - Stakeout

### Description

Stakeout procedures provide information in graphic, numeric and vocal format, to reach a point, an element or in general a particular position. A wide range of options and operative modes are available.

Before proceeding with stakeout, it is necessary to define the coordinate system of the job in order to guarantee the correct matching between surveyed positions and positions to stakeout. If no coordinates system is set, only positions defined in WGS84 coordinates can be staked out.



Commands for measuring points are available when the GPS instrument is in rover mode.

### 14.1

### Stakeout Information

### Description

Information provided by the software during stakeout of a position is similar in all modes. Whether staking out a point, an element or a position by offset, the software provides indications to reach the position to stakeout using a common scheme.

Step	Description
1.	Tap <b>SURVEY</b> .
2.	Tap <b>STAKEOUT</b> .



Refer to the table below for an explanation of the legend numbers.

The toolbar at the bottom provides access to a menu of advanced functions and to commands for measuring points.

Legend	Type	Description
1.	Coordinates	The geographic coordinates (latitude, longitude, elevation) of the receiver. Click to display the plane coordinates (East, North, elevation). Click again to switch back to the geographic coordinates.
2.	Accuracy	The colour of the icons,  or , indicates if the precision level set in the survey parameters, has been reached. The epochs are acquired only when the level of precision has been reached (horizontal and vertical precision, minimum number of satellites, maximum values of DOP, electronic bubble). Below the icon, the current precision values for coordinates (H) and for elevations (V) is displayed.

3. Receiver status



Click to access the **GNSS Status** window.









#### RTK Extra-Safe



Available for Zenith 35 and Zenith 60. The receiver gets corrections from a source and has fixed the ambiguities in **RTK Extra-Safe**.

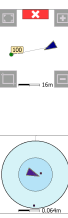

#### RTK Fixed

The receiver gets corrections from a source and has fixed the ambiguities with maximum precision.

Legend	Type	Description
		<b>Quick-Fix</b> Available for Zenith 15, Zenith 16, Zenith 25 and Zenith 40. The receiver has fixed the ambiguities but has not reached the maximum precision level yet.
		<b>RTK Float</b> The receiver gets corrections from a source but it has not yet fixed ambiguities.
		<b>DGPS</b> The receiver gets differential corrections in DGPS mode.
		<b>Autonomous</b> The receiver gets positions without receiving corrections from any source in minimum precision.
4.	Satellites	 Number of satellites tracked, for constellations GPS, GLONASS, BeiDou, SBAS.
5.	Antenna elevation	Elevation of the antenna of the receiver. Click to modify the elevation.
6.	Graphic area and current position	 Graphic view with visualisation of the current position and of the position to reach. Blue: All parameters of operation satisfy the preset level of accuracy. Red: The accuracy parameters are not met.
7.	Numeric indications to reach position	 Indications are referred to <b>North</b> , to <b>Sun</b> or to <b>Reference point</b> . First value refers to distance forward or backward. Second value refers to distance right or left. Third value specifies the elevation difference.
8.	Compass indication	 Shows a compass indicating, with respect to the current direction, the direction of the position to reach. In the lower part is the distance of the point Blue: When more than a meter distance from the position to reach Red: When the receiver has not reached yet the precision check defined In the stakeout settings, define the distance limit stating when to use this type of visualisation. The value of default is set in meter.





Legend	Type	Description
		When the distance from the position to reach is less than one meter this view mode appears. Indications provided and position indicated refer to North or to the sun.
		The background becomes green, when the position is reached within the tolerance values.

**Stakeout tolerance**

A position is reached when the distance between the current position and the position to reach is less or the same as **Tolerance**. The **stakeout tolerance** is set in the Stakeout settings. From every stakeout procedure it is possible to enter in the stakeout parameters and to check tolerance value.



**Information referring to North, the sun or to a reference point**

The information provided in the panel on the right refers to North, to the sun, to a reference point, to previous point or to a reference line. To read the distance values correctly, turn toward North, the sun or the reference point or line. Click a button to change the reference element.

Icon	Description
	Change to North.
	Change to sun.
	Change to reference point.
	Change to previous measured point
	Change to reference line.



**Graphic and analytic view**

Buttons allow to change between analytic and graphic view.

Icon	Description
	Enables the view of analytical mode only, which indicates the distance from the point.
	Enables the graphic window display.
	Enables the mixed display that shows distance from the point and the graphical window.

**Vocal information**

The software guides by vocal information allowing, most of all when you are far from the point, to arrive near the point without having to look always on the controller. A tone tells when the desired position is reached considering the defined tolerance limits.

Icon	Description
	Enables vocal information.
	Disables vocal information.

### Interpret information



After having defined the position to reach, follow two rules to reach the position in the most efficient way.

1. When being far from the point, follow the vocal indications without constantly looking on the controller display. It is sufficient to listen what the software indicates about arriving close to the position to reach.
2. Once being close to the position, at a distance less than one metre, turn with the controller toward North or the Sun. Move the antenna following the indications on the right side of the controller panel. A sound indicates when the position is reached.

## 14.2

### Common Operations in Stakeout

#### Measuring points step-by-step

Step	Description
1.	Reach the stakeout position.
2.	Tap  <b>Measure</b> to start measuring the stakeout point.
3.	The acquisition of positions for the number of epochs set in survey parameters starts. The epochs are acquired if the conditions defined for <b>Accuracy check</b> are met. Refer to <a href="#">Accuracy check step-by-step</a> . Otherwise the software keeps waiting for a manual stop or until the conditions are met.
4.	Tap  <b>Stop</b> to stop measuring.
5.	When the number of defined epochs is reached, confirm the stakeout data displayed.
6.	Tap <b>Next</b> to proceed and define the data of the point to record.
7.	Stakeout data are saved. If required, export the data from window <b>Stakeout report</b> .
8.	The next point to stakeout is automatically proposed by the software.

#### Stakeout parameters step-by-step

Step	Description
1.	Tap  .
2.	Tap <b>Survey settings</b> .
3.	Tap <b>Stakeout</b> .
4.	Refer to <a href="#">Tab Stakeout</a> for a description of the options.
5.	Tap <b>Accept</b> to save the modifications.
6.	When working in <b>Tracking</b> mode, the current measured position can be stored without the need to stop the measurement. As soon as the point is stored it is possible to stake out the next one.

#### Inserting a note step-by-step

Step	Description
1.	Tap  .
2.	Tap <b>Add note</b> .

Step	Description
3.	Add to the fieldbook: <ul style="list-style-type: none"> <li>• Measurements</li> <li>• Descriptive notes</li> <li>• Sketches that can be a valid reference at the moment of elaborating the measured data in the office</li> </ul>

### Points and measurements step-by-step



Step	Description
1.	Tap  .
2.	Tap <b>Points &amp; Measurements.</b>
3.	Refer to <a href="#">Points, Measurements, Survey Codes and GIS Features Management.</a>

### Reference surface step-by-step

Step	Description
1.	Tap  .
2.	Tap <b>Reference surface:</b> .
3.	Define a reference surface to use during stakeout. In this way the software displays the elevation difference between the current position and the corresponding elevation on the reference surface. <ul style="list-style-type: none"> <li>• <b>Surface</b> Set the surface to display.</li> <li>• <b>Display surface</b> Enables and disables the display of the surface.</li> </ul>

### Automatic updating of the view

This command allows to enable and disable the automatic update of the view based on the current position of the receiver.

Icon	Description
	Enables the automatic update of the view so that the receiver position is always visible. The defined reference (North, sun, reference point) is applied.
	Disables the automatic update of the view.

## 14.3

### Stakeout

#### Staking out points step-by-step

Define the mode how to reach the position. The software guides to the position in the most efficient way.

Step	Description
1.	Tap <b>Stakeout.</b>
2.	Tap <b>Points.</b>

Step	Description
3.	<p>Select a mode:</p> <ul style="list-style-type: none"> <li>• <b>Topographic point</b> The nearest topographic point is selected automatically according to the position of the receiver.</li> <li>• <b>Automatic by position</b> The nearest topographic or reference point to stake out is selected automatically according to position of the receiver.</li> <li>• <b>Define points list</b> Create a list of topographic points to stake.</li> <li>• <b>Coordinates</b> Manual definition of East, North and elevation to stake. Coordinates can be selected from the CAD drawing.</li> <li>• <b>Coordinates WGS84</b> Manual definition of the WGS84 coordinates to stake.</li> <li>• <b>Coordinates ECEF</b> Manual definition of the geocentric coordinates to stake.</li> </ul>

---

#### Stakeout of points from a table

---

4. Select a point from the list.  
The icon aside the point indicates if the point is to stake or already staked.
- Point that must be staked.



Point already staked.



- 
5. Tap  **Tools** for operations in the list.
- 

6. Select an operation:
- **Load all points**  
Adds all topographic points from the job to the list.
  - **Load all ref.points**  
Adds all reference points from the job to the list.
  - **Select from table**  
Select topographic points from the job to add to the list.
  - **Select from CAD**  
Select topographic points in the graphic window to add to the list.
  - **Delete points**  
Select points from the list to delete.
  - **Clear list**  
Deletes content of the list.
  - **Load list**  
Load a list of points from a file saved previously.
  - **Save list to file**  
Saves the list of points on an external file to be loaded later.

---

#### Stakeout of ENZ coordinates

---

7. **E, N, Z**  
Enter the coordinates of the position to stake.

8. Tap **Select** to define coordinates by selecting from the graphic window.
- 

#### Stakeout of WGS84 coordinates

---

9. **Latitude, Longitude, Height**  
Geographic coordinates of the position to stake.
- 

#### Stakeout of ECEF coordinates

---

10. **E, N, Z**  
Enter the coordinates of the position to stake. ECEF is a system used in DACH region.

11. Tap **Select** to define coordinates by selecting from the graphic window.
- 

#### Stakeout procedure

---

12. After having defined the position to stake, the main stakeout window appears.

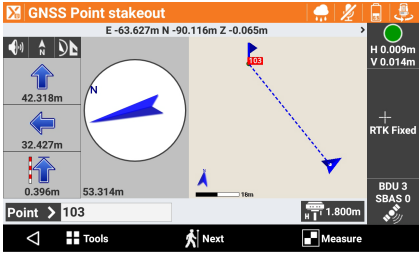

Step	Description
	 <p>The preferred layout of the stakeout screen is stored and used in all jobs until it is changed.</p>

---

### Stakeout of the next point

---

13. Select another object to stakeout by selecting it on the current graphic view.  
OR  
Tap  **Next**.

---

  14. Select the next point to stake in one of the following modes:
    - **Next**  
The next point is suggested, according to recording order.
    - **Previous**  
The previous point is suggested, according to recording order.
    - **Nearest**  
The nearest point, which has not been staked yet, is suggested.
    - **Point from CAD**  
Manual selection of the point to stake in the graphic window.
    - **Point from Table**  
Manual selection of the point to stake from the table.
- 

### Staking out lines/arcs/objects step-by-step

Stake out with precision along geometric elements such as lines, arcs or drawing elements.

Step	Description
1.	Tap <b>STAKEOUT</b> .
2.	Tap <b>Objects</b> .
3.	Select a mode: <ul style="list-style-type: none"> <li>• <b>Line (2 points)</b> Line defined by two topographic points.</li> <li>• <b>Arc (3 points)</b> Arc defined by three topographic points.</li> <li>• <b>Arc (2 points+R)</b> Arc defined by two topographic points and by the radius.</li> <li>• <b>Drawing object</b> Select a line, polyline, arc or circle in the graphic window.</li> </ul>

---

### Stakeout a line by two points

---

4. Select:
    - **Point 1**  
First point of the reference line
    - **Point 2**  
Second point of the reference line
    - **Invert**  
Inverts the direction of the line.
    - **Info...**  
Shows the information of the object.
- 

### Stakeout of arc by three points

---

5. Select:
    - **Point 1**  
First point of the reference arc
    - **Point 2**  
Second point of the reference arc
    - **Point 3**  
Third point of the reference arc
    - **Invert**  
Inverts the direction of the line.
    - **Info...**  
Shows the information of the object.
-

Step	Description
------	-------------

Stakeout of arc by two points and radius	
--	--

- |    |   |
|----|---|
| 6. | Select: <ul style="list-style-type: none"> <li>• <b>Point 1</b><br/>Starting point of the reference arc</li> <li>• <b>Point 2</b><br/>Ending point of the reference arc</li> <li>• <b>Radius</b><br/>Radius of the reference arc</li> <li>• <b>Arc clockwise</b><br/>Direction of the reference arc</li> <li>• <b>Invert</b><br/>Inverts the direction of the line.</li> <li>• <b>Info...</b><br/>Shows the information of the object.</li> </ul> |
|----|---|

Stakeout of CAD element	
-------------------------	--

- |    |  |
|----|--|
| 7. | Select the drawing element to stake from the graphic window. |
|----|--|

Offset	
--------	--

- |    |   |
|----|---|
| 8. | After defining the stakeout element, an additional offset to the right or to the left can be defined. <ul style="list-style-type: none"> <li>• <b>Offset</b><br/>Distance to observe referring to reference element</li> <li>• <b>Height diff.</b><br/>Vertical offset. Start from a reference object and apply a 3D offset.</li> <li>• <b>Multiplier</b><br/>Activates the stakeout of multiple offsets according to the set value of reference offset. When the option is active, the software shows the distance from the nearest offset and displays the multiplication factor of the offset distance.</li> </ul> |
|----|---|

Stakeout procedure	
--------------------	--

- |    |   |
|----|---|
| 9. | After having defined the position to stake, the main stakeout window appears. |
|----|---|

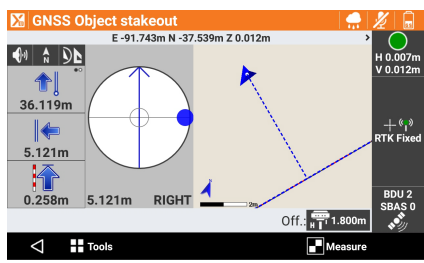

Information of stakeout:



Current position is on the left referring to the reference element.



Current position is on the right referring to the reference element.



Current position is on the reference element.

Icon



To visualise the distance from the end of the object.

Step	Description
	 <p>To visualise the distance from the beginning of the object.</p>

## Staking out station and offset step-by-step

Stake out positions referring to a station distance and an offset distance on a reference element.

Step	Description
1.	Tap <b>STAKEOUT</b> .
2.	Tap <b>Chainage &amp; offset</b> .
3.	Select a mode: <ul style="list-style-type: none"> <li>• <b>Line (2 points)</b> Line defined by two topographic points.</li> <li>• <b>Arc (3 points)</b> Arc defined by three topographic points.</li> <li>• <b>Arc (2 points+R)</b> Arc defined by two topographic points and by the radius.</li> <li>• <b>Drawing object</b> Select a line, polyline, arc or circle in the graphic window.</li> </ul>

### Stakeout by offset referring to a line by two points

4. Select:
- **Point 1**  
First point of the reference line
  - **Point 2**  
Second point of the reference line
  - **Invert**  
Inverts the direction of the line.
  - **Info...**  
Shows the information of the object.

### Stakeout by offset referring to an arc by three points

5. Select:
- **Point 1**  
First point of the reference arc
  - **Point 2**  
Second point of the reference arc
  - **Point 3**  
Third point of the reference arc
  - **Invert**  
Inverts the direction of the line.
  - **Info...**  
Shows the information of the object.

### Stakeout by offset referring to an arc by two points and radius

6. Select:
- **Point 1**  
Starting point of the reference arc
  - **Point 2**  
Ending point of the reference arc
  - **Radius**  
Radius of the reference arc
  - **Arc clockwise**  
Direction of the reference arc
  - **Invert**  
Inverts the direction of the line.
  - **Info...**  
Shows the information of the object.

### Stakeout by offset referring to a CAD element

7. Select the drawing element to stake from the graphic window.

### Offset parameters

Step	Description
8.	Define: <ul style="list-style-type: none"> <li>• <b>Chainage</b> Distance on the reference element on which is the position to reach.</li> <li>• <b>Interval</b> Distance between the stakeout points along the reference element. Use the button on the right to calculate the interval dividing the length of the reference element in a defined number of parts.</li> <li>• <b>Offset</b> Distance perpendicular to the reference element. Use the button on the right to define if the desired position is on the right or on the left of the reference element.</li> <li>• <b>Height diff.</b> Elevation difference to apply to the calculated point. The software interpolates the elevation on the reference element with the defined station distance. A slope can be added to the interpolated elevation.</li> </ul>

9. Tap **Next** to start staking out of the calculated position.

**Stakeout procedure**

10. After having defined the reference element and the offset parameters, the main stakeout window appears. The distance from the station and the offset of the position are displayed at the bottom. When staking with offset, change the distance and the offset directly in the stakeout window.



11. Select another object to stakeout by selecting it on the current graphic view. OR Tap **Next** to stake out the next point. The procedure returns to the panel where the station distance and the offset are defined. A station distance increased of the interval value is suggested.

**Staking out side slopes step-by-step**

Calculate and stake out positions of the point of intersection of the project side slope with the existing terrain.

The stakeout position is calculated from the following information:

- From the point position to the projection of the slope
- Distance to the stakeout element

Step	Description
1.	Tap <b>STAKEOUT</b> .
2.	Tap <b>Sideslopes</b> .
3.	The requests that are performed are exactly the same as for stakeout by offset. Refer to <a href="#">Staking out lines/arcs/objects step-by-step</a> . A tab for the definition of the slopes is added.



**Slopes**

Step	Description
4.	Define: <ul style="list-style-type: none"> <li>• <b>Cut</b> Slope value in the cut condition (receiver elevation above the starting elevation of the slope).</li> <li>• <b>Fill</b> Slope value in the fill condition (receiver elevation under the starting elevation of the slope).</li> </ul>
5.	Tap <b>Next</b> to start staking out of the calculated position.

### Stakeout procedure

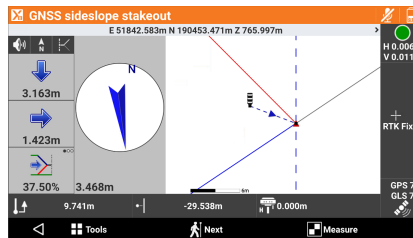
- After having defined the reference element, the offset parameters and slopes, the main stakeout window appears.



In addition to the visualisation mode described in previous paragraphs, this graphical view contains the cross section of the side slope and current position. To change the visualisation mode tap the icons , , and .



The side panel contains the information to get the point of intersection. First value refers to the vertical distance from the position to side slope. Second value refers to the horizontal distance from the position to side slope. Third value shows the current value of the slope and the direction to take, on the perpendicular to the reference element, to achieve the project slope value. It is possible to change the shown information: hit it or scroll.

### Staking out side slopes for excavation step-by-step

Stakeout side slopes that start from a closed polyline and that represent, for example, the bottom of an excavation.

- Finding the catch point with the existing ground
- Checking side slopes created by the excavator

Step	Description
1.	Tap <b>STAKEOUT</b> .
2.	Tap <b>Sideslopes automatic</b> .
3.	The requests that are performed are exactly the same as for stakeout by offset. Refer to <a href="#">Staking out station and offset step-by-step</a> . Select the polyline. A tab for the definition of the slopes is added.

### Slopes

- Define:
  - **Offset**  
Horizontal distance from the position to side slope.
  - **Slope**  
Slope between the polyline and the current position
  - **Ref. elevation**  
Sets the reference elevation to use for the elevation check.

Step	Description
------	-------------

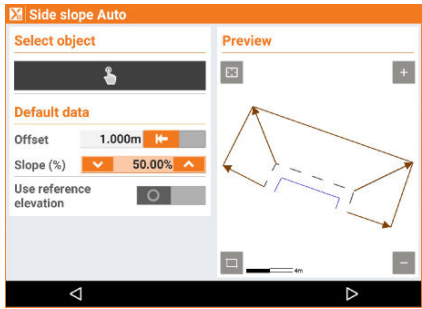

5. Tap **Next**.

**Stakeout procedure**

6. The position along the side slope is calculated and displayed.

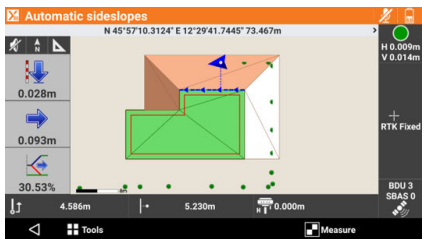

First value refers to the current elevation below or above the reference elevation. Second value refers to the horizontal distance from the position to side slope. Third value shows the current value of the slope and the direction to take, on the perpendicular to the reference element, to achieve the project slope value.

**Stake out surfaces step-by-step**

Determine in the field the design elevation of a three-dimensional surfaces loaded in current job. For every position, the elevation of the current position is compared with the elevation interpolated on the surface and the difference of elevation is calculated.

The surfaces stakeout can be used for:

- Stakeout of a planned surface in the field
- Quality check to test the correspondence between the built and the plan

Step	Description
------	-------------

1. Tap **Next**.

2. Tap **Surfaces**.

3. Select a surface to stake from the ones loaded in the job.

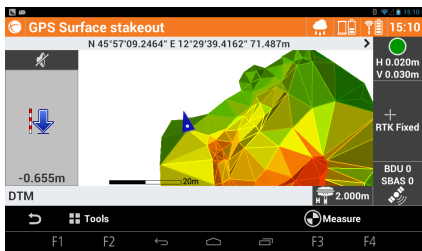

4. The side panel visualises in real-time the difference of elevation between the current position and the elevation interpolated on the surface.

5. In the input field, manage the point name.



## Stakeout report step-by-step

All stakeout data related to stakeout of points or elements are recorded in the job.

This command allows reading and exporting the data. Available output formats:

- ASCII
- CSV for Excel
- XML for Excel
- PDF
- HTML

Step	Description
1.	Tap <b>STAKEOUT</b> .
2.	Tap <b>Report</b> .
3.	A table presents the list of all stakeout points with differences, in distances and elevations, between the design coordinate and the stakeout coordinate.
4.	Tap  <b>Share</b> to create an ASCII, CSV, XML or PDF document, with all stakeout data of every point.

**Description**

In this chapter it is explained how to modify main parameters of the total station as for example the type of target or the mode of measure. For the robotic total station, it is explained how to perform the search of prism and how to control the direction of the station.







The functions explained are available for all windows of survey and stakeout.

**Mechanic total station - control panel**

Allows to control the basic functions of mechanic total station.

Step	Description
1.	Tap  .

Icon	Description
	Standard measurement mode
	Fast measurement mode
	Tracking measurement mode (continuous measurement)
	Activates visualisation of the bubble
	Remote control is off. Tap to activate the remote control when using the controller on the pole.
	Remote control is on. Tap to deactivate remote control when using the controller on total station.

**Robotic total station - control panel**

Allows full control of all functions of the robotic total station.







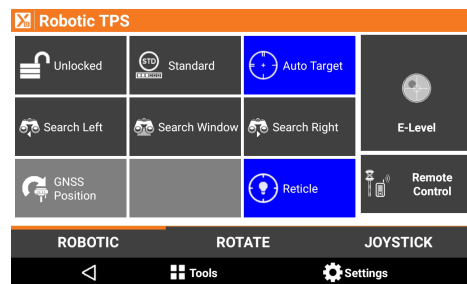







Step	Description
1.	Tap  .

Parameters and options are organised in pages.

**ROBOTIC page**









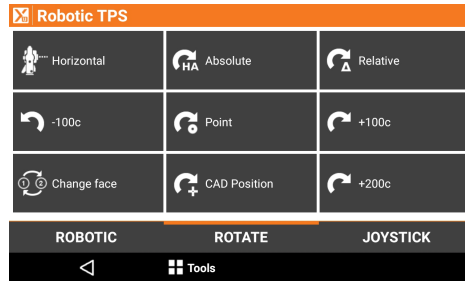



Icon	Description
	Prism is unlocked. Tap to lock the prism.
	Prism is locked. Tap to unlock the prism.
	Current measure mode: Standard
	Current measure mode: Fast
	Current measure mode: Tracking (continuous measuring)
	Automatic aiming of prism is deactivated. Tap to activate the automatic aiming.
	Automatic aiming of prism is activated. Tap to deactivate the automatic aiming.
	Tap to start the automatic prism search to the left.
	Tap to start the automatic prism search within a defined window. If the window has not been defined yet, the limits can be defined.
	Tap to start the automatic prism search to the right.
	Tap to start the automatic prism search using the GPS position of the receiver placed on the pole (X-Pole). Tap to start the automatic prism search using the GPS position of the controller if the method <b>Use controller's GNSS</b> has been selected in <b>Settings</b> .
	Tap to activate the lights for the direction of stakeout.
	Tap to display the bubble
	Remote control is off. Tap to activate the remote control when using the controller on the pole.
	Remote control is on. Tap to deactivate remote control when using the controller on total station.

## ROTATE page







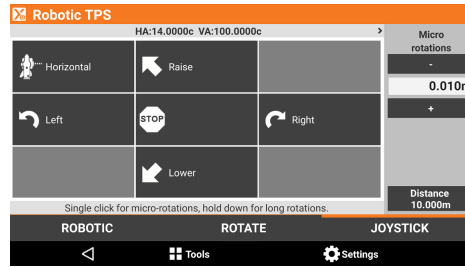

Icon	Description
	Tap to rotate the telescope horizontally.
	Tap to rotate the total station to a specific horizontal angle.
	Tap to rotate the total station to a specified angular value.
	Tap to rotate the total station 100 gon (90 degrees) to the left.
	Tap to rotate the total station to a topographic point. Select the topographic point directly in the graphic window.
	Tap to rotate the total station 100 gon (90 degrees) to the right.
	Tap to rotate the total station to the opposite face.
	Tap to rotate the station to a position. Select the topographic point directly in the graphic window.
	Tap to rotate the total station 200 gon (180 degrees) to the right.

## JOYSTICK page



### Using the icons to allow rotation

Action	Description
<b>Hold down</b>	The speed of rotation increases progressively and stops when it is released.
<b>Single click</b>	Performs a microrotation.



Icon	Description
	Tap to rotate the total station to the left. Tap again to increase the speed.
	Tap to rotate the total station to the right. Tap again to increase the speed.
	Tap to rotate the total station upwards. Tap again to increase the speed.
	Tap to rotate the total station downwards. Tap again to increase the speed.
	Tap to stop the rotation.
	Tap to rotate telescope to horizontal position.

Field	Description
<b>Micro</b>	Sets the accuracy of microrotation movements.
<b>Distance</b>	Displays the approximate distance for calculating the angle of the microrotations. Hit the field to measure the distance from to the target.

### Defining the search area of fixed targets

Step	Description
1.	Tap  .
2.	Define the settings manually or using the instrument.

**Manual definition**

Step	Description
3.	Define the parameters of the search window: <ul style="list-style-type: none"> <li>• <b>Search Window</b> Activate to allow the prism search only inside the defined window.</li> <li>• <b>HA Minimum</b> Horizontal angle defining the left limit of the search zone</li> <li>• <b>HA Maximum</b> Horizontal angle defining the right limit of search zone</li> <li>• <b>VA Minimum</b> Vertical angle defining the lower limit of search zone</li> <li>• <b>VA Maximum</b> Vertical angle defining the upper limit of search zone</li> </ul>
4.	Define the distance limits: <ul style="list-style-type: none"> <li>• <b>Distance range</b> Activate to limit the search inside distance limits</li> <li>• <b>Dist. Minimum</b> Minimum distance of the search</li> <li>• <b>Dist. Maximum</b> Maximum distance of the search</li> </ul>
5.	Define the AiM360 settings: <ul style="list-style-type: none"> <li>• <b>AiM360 mode</b> Configure the automatic collimation according to the environmental situation: <b>Normal, Low visibility</b> or <b>High reflectivity</b>.</li> </ul>
<b>Definition using the instrument</b>	
6.	Tap  .
7.	Tap <b>Define window</b> .
8.	Aim to the lower left of the search window and then to the upper right.
9.	Tap  .
10.	Tap <b>New center</b> .
11.	Specify a new center for the search window.
12.	Tap  .
13.	Tap <b>Show window</b> .
14.	Check the defined search window.

### Defining the environmental parameters (temperature, pressure, refraction / sphericity)

Step	Description
1.	Tap  .
2.	Tap <b>TPS Coefficients</b> .
3.	Define values that must be considered for the calculation of the distances measured. <p><b>Temperature and Pressure</b></p> <ul style="list-style-type: none"> <li>• <b>Atmospheric correction</b> Activate to define and consider the parameters.</li> <li>• <b>Temperature (°C)</b> Value for the temperature in degrees Celsius</li> <li>• <b>Pressure (mb)</b> Value for the pressure in millibar</li> <li>• <b>Humidity (%)</b> Value for humidity in percent</li> <li>• <b>Atmospheric PPM</b> The calculated PPM considering all parameters is displayed.</li> </ul> <p><b>Refraction &amp; Sphericity</b></p> <ul style="list-style-type: none"> <li>• <b>Refractive/Sphericity</b> Activate to define and consider the parameters.</li> <li>• <b>Refraction coeff.</b> Value for the refraction</li> </ul>

## Searching for fixed targets





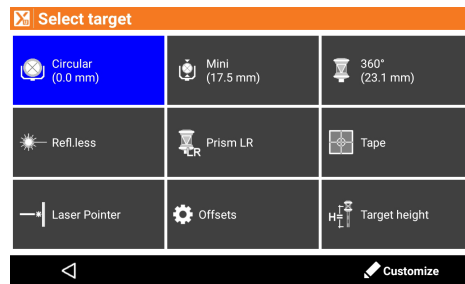

Step	Description
1.	Tap  .
2.	Tap <b>Search fixed targets</b> .
3.	The command activates the scanning for fixed targets at 360° to store their position to exclude them when the automatic prism search mode is active.

## Setting the target type

Allows to edit the target to use for the measurements.

Step	Description
1.	Tap  .



Icon	Description
Six upper fields	The six fields in the upper part contain six prism types. It is possible to customise the buttons with favorite prism types.
	Tap to activate measure mode without prism.
	Tap to activate measure mode for long range.
	Tap to activate measure mode to tape.
	The laser pointer is deactivated. Tap to activate the laser pointer.
	The laser pointer is activated. Tap to deactivate the laser pointer.
	Tap to define the prism constants to use both for measurements with prism and without prism.
	Tap to edit the height of the pole.

## Defining the favourite prisms shown in the top six icons

Step	Description
1.	Tap  .
2.	Tap on the buttons until the desired type of prism is displayed.

## Checking and defining target constants

Step	Description
1.	Tap  .
2.	<p>Check the constants of different types of prism and specify the constant to use for the user type of prism.</p> <ul style="list-style-type: none"> <li>• <b>Reflector type</b> Type of prism</li> <li>• <b>Constant (mm)</b> Constant of the prism. The value is editable only for the user type of prism.</li> <li>• <b>Constant absolute (mm)</b> Absolute constant of prism. The value is editable only for the user type of prism.</li> <li>• <b>Target height offset (mm)</b> Specify an additional height offset for each target to ensure that the final height of the prism is correct. To use the GNSS pole and adapt it to be used with the prism. With an adapter, the same pole can be used for GNSS and TPS measurements.</li> </ul>
3.	<p>Define a constant to use in case of measurements without prism or to tape.</p> <ul style="list-style-type: none"> <li>• <b>Target name</b> User defined name for the tape or reflectorless target</li> <li>• <b>Reflector type</b> <b>Tape</b> or <b>Refl.less</b></li> <li>• <b>Offset</b> Similar to the target constant for prisms. To be defined for cases with fixed offset that has to be considered in the measurements.</li> <li>• <b>Target height offset (mm)</b> Specify an additional height offset to ensure that the final height of the tape or reflectorless surface is correct.</li> </ul>





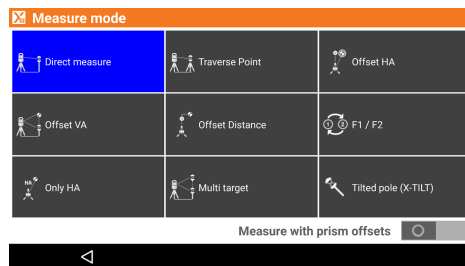

## Setting the measure mode

Allows to edit the type of measurements.

Step	Description
1.	Tap  .



Icon	Description
	<p><b>Direct measure</b> Measure directly to a point.</p>
	<p><b>Traverse Point</b> Specifies that the next point measured is a polygonal point. The polygonal points are saved to allow a rapid change of station.</p>

Icon	Description
	<b>Offset HA</b> Performs a measurement to an object for which the prism cannot be placed at the point to measure.
	<b>Offset VA</b> Performs a measurement to a point not accessible directly by the prism but above or below.
	<b>Offset Distance</b> Performs a measurement to a point not accessible directly by the prism but at a certain distance along the direction between station and prism.
	<b>Face1/Face2</b> Performs a measurement to a point in both faces and calculates the average.
	<b>Only HA</b> Performs only an angle measurement to a point.
	<b>Multi target</b> Performs a measurement using a multi target pole.
	<b>Tilted pole (X-TILT)</b> Performs a measurement to a point with two tilted pole measurements.
	<b>Measure with prism offsets</b> Performs a measurement to points applying an offset to prism measurements. The offset can be left, right or longitudinal.

### Defining the strategy for prism search step-by-step



Step	Description
1.	Tap <b>Settings</b> .
2.	Tap <b>TPS</b> .
3.	Tap <b>TPS</b> page.
4.	Define a default action for when the prism is lost. <ul style="list-style-type: none"> <li>• <b>None</b> No action is started.</li> <li>• <b>360°</b> Starts a prism search at 360°. Windows + 360</li> <li>• <b>360° search</b> A search window is started in the area where the prism was lost and then a 360° search is done.</li> <li>• <b>Return to last pos.</b> The station returns to the last direction where the prism was locked.</li> <li>• <b>Use controller's GNSS</b> Use the GPS position of the controller to search for the prism.</li> </ul>

### Use controller's GNSS

The prism is searched based on the location of the controller provided by the internal GPS of the device. The search system starts only after at least three points have been measured. This allows the automatic definition of a search system, **SmartLocalization**. The system is able to rotate the total station toward the direction in which the controller is located.

The search system continuously improves the accuracy and reliability for each measured point. An icon indicates when the system is able to search for a prism:



Icon	Description
	The system is able to search for the prism.





Icon	Description
	The system is not yet able to search for the prism.
	The correct functioning of the system depends on the quality of the GNSS position of the stored points. It is possible to cancel the current calculation system and to return to the starting point where the measurement of the three points has been started. Reset the system by opening the control window of the robotic station, hit the <b>Tools</b> and select <b>Reset SmartLocalization data</b> .



Description







If the current profile is related to a total station, a window to perform simple measurements without saving data can be opened from main menu at every moment.





Step	Description
1.	Tap  or  .

Icon	Description
	Access to the control panel of the robotic total station.
	Access to the control panel of the mechanic total station.
	Setting of an horizontal angle for the station.
	Starting measurements. At the end of the measurements, the distances measured are reported in corresponding fields.



In the upper part of the window, a panel allows to access to other functions to control the total station.

Icon	Description
	The current type of target. Tap to access a window that allows to change the type of target and the target height.
	Prism is unlocked. Tap to lock the prism. Tapping longer on the icon starts the prism search without the need to select the corresponding command in the <b>Robotic TPS</b> window. Double tapping on the icon sets the telescope horizontal and then starts the search of the prism.
	Prism is locked. Tap to unlock the prism.
	Automatic aiming of prism is deactivated. Tap to activate the automatic aiming.
	The laser pointer is deactivated. Tap to activate the laser pointer.
	The laser pointer is activated. Tap to deactivate the laser pointer.
	Current measure mode: Standard

Icon	Description
	Current measure mode: Fast
	Current measure mode: Tracking (continuous measuring)
	Sets the instrument height.
	Displays the E-Bubble.

**Description**

Making the orientation of the station is a main step perform operations of surveying, stakeout and auto measuring with total station.

Step	Description
1.	Tap <b>SURVEY</b> .
2.	Tap <b>Station setup</b> .
3.	Select a method: <ul style="list-style-type: none"> <li>Using previous setup If an orientation has been set previously, that orientation is proposed. The orientation can be accepted or a new orientation can be defined.</li> <li>Using the orientation of another job The software saves the orientation of the current job so that it can be used again when the same job or another job is opened. When another job is opened the current orientation is suggested.</li> <li>Loading the orientation stored in the station With some total stations it is possible to perform some part of the survey with the X-PAD version running on board of the instrument and the other part with the version running on the external controller. If the station orientation was performed with one of the two versions, the other version can continue to use the same orientation because the data of the latter were stored inside the station itself.</li> </ul>

**Using previous setup**

4. Tap to define a new orientation.



- Hit **Accept** to confirm current orientation.

**Using the orientation of another job**

5. Select the orientation from another job.

**Loading the orientation stored in the station**

6. Load the orientation data by specifying to use a new orientation.  
7. Select **Load internal TPS orientation**. Refer to [New orientation](#).

**Select point for station setup**

8. The procedures for the station setup share the following options for selecting one or more points.
- CAD**  
Select the point to use as reference point from the CAD window.
  - Topographic points**  
Select the point to use as reference points from the topographic point table.
  - Reference points**  
Select the reference point from the reference points table.
  - Add point**  
Insert the reference point coordinates directly.

**Description**

The procedures for the station setup share the following options for the instrument height calculation.

Step	Description
1.	Tap > of the field <b>Instrument height</b> .

**Calculate instrument height from slant height**

Measure the slant height on the TPS side marker. The instrument height is calculated using the reference width.

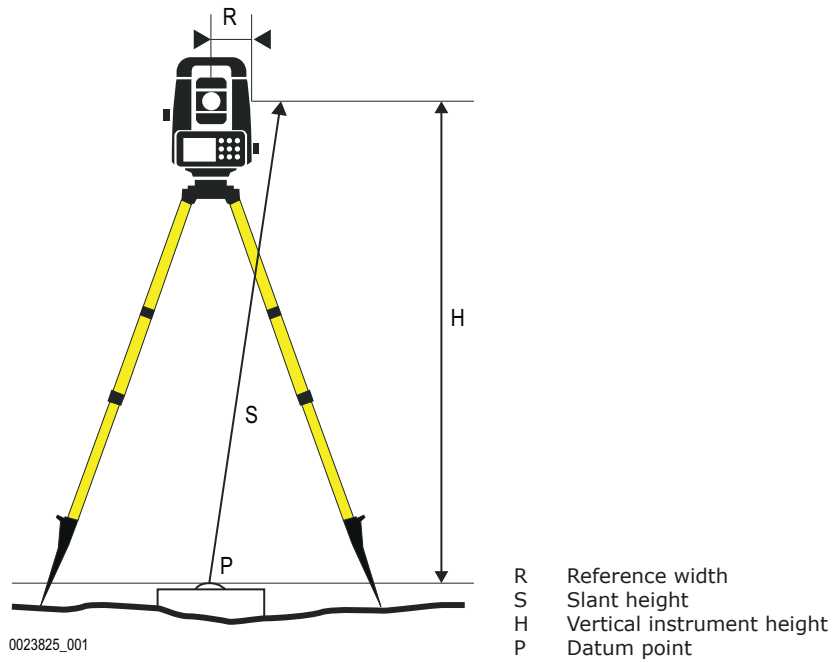

Field	Description
<b>TPS model</b>	Brand and model of the active profile
<b>TPS reference width (R)</b>	Sets the reference width.
<b>Slant height (S)</b>	Slant height
<b>Instrument height (H)</b>	Calculated instrument height

#### Calculate instrument height from keyboard height

Measure the slant height to the bottom border of the keyboard. The instrument height is calculated using the offset values.

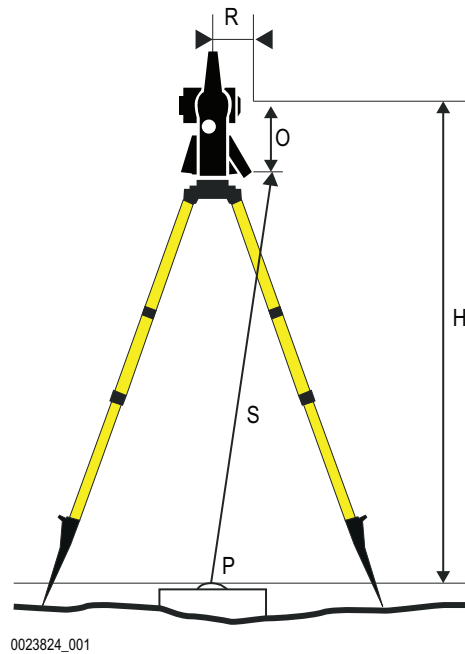

- R Keyboard horizontal offset
- O Keyboard vertical offset
- S Slant height
- H Vertical instrument height
- P Datum point

Field	Description
<b>TPS model</b>	Brand and model of the active profile
<b>Keyboard horiz. offset (R)</b>	Horizontal distance from the center of the telescope to the bottom border of the keyboard
<b>Keyboard vert. offset (O)</b>	Vertical distance from the bottom border of the keyboard to the center of the telescope
<b>Slant height (S)</b>	Slant height
<b>Instrument height (H)</b>	Calculated instrument height

### Calculate instrument height from reference point

The reference point for the calculation must be measured.

Field	Description
<b>Station elevation</b>	Elevation of the station
<b>Reference value</b>	Select: <ul style="list-style-type: none"> <li>• <b>Reference point</b> Requires either the coordinates of a known point or pointing the telescope to and measure a known point.</li> <li>• <b>Reference elevation</b> Requires pointing the telescope to a known point with the desired elevation.</li> </ul>
<b>Point</b>	Reference point for the calculation. Tap > to access to the options.
<b>Elevation</b>	Shows or sets the reference elevation according to the set reference value.
<b>Instrument height (H)</b>	Calculated instrument height

## 17.1

### Orientation

#### New orientation

Opening a job, the software allows the creation of a new orientation that can be of one of the following types.



When a job is opened, using the last station setup used is also an option.

Type	Description
<b>Station point already exists.</b>	The station is already stored as a point in the current job file or the coordinates are known.
<b>Station elevation has not been calculated.</b>	The station coordinates and the orientation needs to be calculated by measuring some reference points.
<b>No orientation</b>	The station position can be defined without any specific orientation.
<b>Load internal TPS orientation</b>	Available for Zoom 70, Zoom 75, Zoom 80, Zoom 90 and Zoom 95. The total stations can store the orientation made with other software. With this option, the internal orientation of the total station is loaded and set as the current orientation. The orientation consists of the coordinates of the station and the instrumental height. It is assumed that the correction angle is equal to 0. With this option, the orientation can be shared between different sessions of X-PAD running on the external controller or onboard.

### New orientation to known position step-by-step

#### Requirements

- The station is already stored in the current job as point.
- The coordinates of the station are known.

#### Available methods

Type	Description
<b>Backsight to known point</b>	The station has been placed on a point of known coordinates and the orientation is determined through the measurement of a reference point with known coordinates.
<b>Backsight by azimuth</b>	The station has been placed on a point with known coordinates and the orientation is determined through the measurement of a reference point with known azimuth.
<b>Orientation to multi points</b>	The station has been placed on a point with known coordinates and the orientation is determined through the measurement of some reference points with known coordinates.
<b>Backsight to known point &amp; traverse</b>	The station has been placed on a point with known coordinates and the orientation is determined through the measurement of a reference point with known coordinates and a foresight traverse point.

#### Orientation to known point



Step	Description
	The reference point must available in the list of topographic points or in the list of reference points.
1.	Define the station. <ul style="list-style-type: none"> <li>• <b>Station</b> Name of the station. Select a point existing in the job.</li> <li>• <b>Instrument height</b> Elevation of the total station from the ground. It is possible to calculate the height of the instrument in different ways, refer to <a href="#">Description</a>. To access the options tap &gt;.</li> <li>• <b>Code</b> Code to assign to the station point in case a new point is created.</li> <li>• <b>E, N, Z</b> Coordinates of the station. When an existing point was selected, the values cannot be edited.</li> </ul>
2.	Tap <b>Next</b> to proceed with the guided procedure.

Step	Description
3.	Define the reference point. <ul style="list-style-type: none"> <li>• <b>Point</b> Specify the reference point which must be measured for the calculation of the station orientation.</li> <li>• <b>Azimuth</b> The azimuth between the position of the station and the reference point is calculated.</li> <li>• <b>Circle</b> Define how to set the horizontal angle of the station:               <ul style="list-style-type: none"> <li>• <b>Current value</b> The angle of the station is not modified</li> <li>• <b>Zero</b> The angle of the station is reset to the reference point.</li> <li>• <b>Azimuth</b> The angle of the station is set to the azimuth value.</li> </ul> </li> </ul>
4.	Aim the point of orientation.
5.	Tap <b>Measure</b> .
6.	The calculated data and the differences for angle and distance are displayed.
7.	Tap <b>Accept setup</b> to confirm set data and complete procedure.
	When using with at least three points, it is not necessary to specify the name of the reference points. Aim at the points and measure them. X-PAD identifies the reference points from the list of reference points stored in the job. The free station is calculated. The results are displayed.

#### Orientation by azimuth

Step	Description
1.	Define the station. <ul style="list-style-type: none"> <li>• <b>Station</b> Name of the station. Select a point existing in the job.</li> <li>• <b>Instrument height</b> Elevation of the total station from the ground. It is possible to calculate the height of the instrument in different ways, refer to <a href="#">Description</a>. To access the options tap &gt;.</li> <li>• <b>Code</b> Code to assign to the station point in case a new point is created.</li> <li>• <b>E, N, Z</b> Coordinates of the station. When an existing point was selected, the values cannot be edited.</li> </ul>
2.	Tap <b>Next</b> to proceed with the guided procedure.
3.	Define the reference point. <ul style="list-style-type: none"> <li>• <b>Azimuth</b> The azimuth between the position of the station and the reference point is calculated.</li> <li>• <b>Circle</b> Define how to set the horizontal angle of the station:               <ul style="list-style-type: none"> <li>• <b>Current value</b> The angle of the station is not modified</li> <li>• <b>Zero</b> The angle of the station is reset to the reference point.</li> <li>• <b>Azimuth</b> The angle of the station is set to the azimuth value.</li> </ul> </li> </ul>
4.	Aim the point of orientation.
5.	Tap <b>Measure</b> .
6.	The calculated data and the differences for angle and distance are displayed.
7.	Tap <b>Accept setup</b> to confirm set data and complete procedure.

## Orientation to multi points

Step	Description
1.	<p>Define the station.</p> <ul style="list-style-type: none"> <li>• <b>Station</b> Name of the station. Select a point existing in the job.</li> <li>• <b>Instrument height</b> Elevation of the total station from the ground. It is possible to calculate the height of the instrument in different ways, refer to <a href="#">Description</a>. To access the options tap &gt;.</li> <li>• <b>Code</b> Code to assign to the station point in case a new point is created.</li> <li>• <b>E, N, Z</b> Coordinates of the station. When an existing point was selected, the values cannot be edited.</li> </ul>
2.	Tap <b>Next</b> to proceed with the guided procedure.
3.	Define the first reference point and perform the corresponding measurement. It is possible to enter the reference name, select it from the list of points, from the list of the reference points or from the graphic window.
4.	Aim at the reference point.
5.	Tap <b>Measure</b> .
6.	Perform the same operation for the second reference point.
7.	<p>The two measured points are reported in a table showing the differences calculated at each point and the total standard deviation on the orientation calculation.</p> <p> Enables and disables the use of the measurement for the orientation calculation of the station.</p> <p> Adds the measurement of other reference points to improve the quality of the calculation and for more control of the data.</p> <p> Confirmation of the calculated data. A report with the calculated data is displayed.</p>
8.	Tap <b>Accept setup</b> to confirm set data and complete procedure.

## Orientation by backsight to known point and traverse

Step	Description
1.	<p>Define the traverse settings.</p> <ul style="list-style-type: none"> <li>• <b>Measurements order</b> <ul style="list-style-type: none"> <li>• <b>BS1-FS1-BS2-FS2</b> All points are measured in face I, then measured in face II in reverse sequential order.</li> <li>• <b>BS1-FS1-BS2-FS2</b> All points are measured in face I, then measured in face II.</li> <li>• <b>BS1-BS2-FS1-FS2</b> Backsight point is measured in face I immediately followed by face II. Other points are measured in face I, face II order.</li> <li>• <b>BS1-BS2-FS2-FS1</b> Backsight point is measured in face I immediately followed by face II. Other points are measured in alternating face order.</li> <li>• <b>BS1-FS1</b> All points are measured in face I only.</li> </ul> </li> <li>• <b>Measure F1/F2</b> Option to define if only one foresight point or multiple points are used during the sets.</li> <li>• <b>Number of sets</b> Number of measured sets.</li> </ul>



Step	Description
2.	Define the station. <ul style="list-style-type: none"> <li>• <b>Station</b> Name of the station. Select a point existing in the job.</li> <li>• <b>Instrument height</b> Elevation of the total station from the ground. It is possible to calculate the height of the instrument in different ways, refer to <a href="#">Description</a>. To access the options tap &gt;.</li> <li>• <b>Code</b> Code to assign to the station point in case a new point is created.</li> <li>• <b>E, N, Z</b> Coordinates of the station. When an existing point was selected, the values cannot be edited.</li> </ul>
3.	Tap <b>Next</b> to proceed with the guided procedure.
4.	The procedure guides to measure the backsight point, the next foresight traverse point in direct and reverse face and checks the errors.
5.	When stationing is completed, the procedure guides to move to the next traverse point and continue the process with the backsight of the previous traverse point.





New orientation with a position has to be calculated step-by-step

#### Available methods

Type	Description
<b>Free station</b>	The position and the orientation of the station are determined by measuring at least two reference points with known coordinates.
<b>Auto Free station</b>	Available for robotic total stations. Performs an automatic search and measurement of all the targets around the station. The position and orientation of the station are determined by comparing the measurements with the reference points which have to be present in the job.
<b>Reference axis</b>	The position and orientation of the station are determined by measuring of two reference points. The two points set the origin and direction of the X axis.
<b>2 reference axis</b>	The position and orientation of the station are determined by measuring four reference points. The points set two axes which, intersecting each other, determine the position of the station.
<b>Batter boards</b>	The position and orientation of the station are determined by measurements of three reference lines which, intersecting each other, determine the two positions corresponding to two reference point of the project.
<b>Free station 3D</b>	The position and the orientation of the station are determined by measuring of at least three reference points with known coordinates. The software will perform a 3D spatial transformation (Helmert 3D).

#### Free station

Step	Description
1.	Define the station. <ul style="list-style-type: none"> <li>• <b>Station</b> Name of the station. A new name must be defined.</li> <li>• <b>Instrument height</b> Elevation of the total station from the ground. It is possible to calculate the height of the instrument in different ways, refer to <a href="#">Description</a>. To access the options tap &gt;.</li> <li>• <b>Code</b> Code to assign to the station point in case a new point is created.</li> </ul>
2.	Tap <b>Next</b> to proceed with the guided procedure.
3.	Define the first reference point and perform the corresponding measurement. It is possible to enter the reference name, select it from the list of points, from the list of the reference points or from the graphic window.

Step	Description
	<p><b>Select point</b></p> <p> CAD</p> <hr/> <p> Topographic Points</p> <hr/> <p> Reference Points</p> <hr/> <p> Add point</p> <p style="text-align: right;"><b>CANCEL</b></p>

- Aim at the reference point.
- Tap **Measure**.  
Tap **Accept setup** to confirm set data and complete procedure.

**Using X-Pole in X-Pole configuration**

- Use the position provided by the GPS receiver as a known position as station for the total station.  
When being asked to indicate the point of known coordinates, choose item **Measure GNSS**.
- Measure the point with GPS.
- Measure the same with the total station.
- Perform the same operation for the second reference point.
- The two points measured are displayed in a table.  
Displayed is:
  - The calculated standard deviation of every point
  - The total standard deviation for the calculated station position.

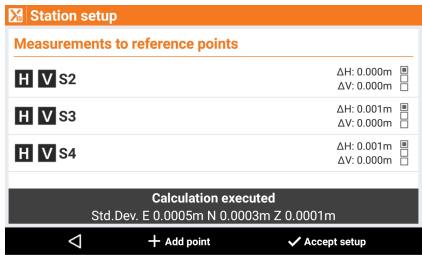

Enables and disables the use of the measurement for the orientation calculation of the station.



Enables and disables the use of the measurement for the elevation calculation of the station.



Tap to change the types of differences displayed.



Adds the measurement of other reference points to improve the quality of the calculation and for more control of the data.

Step	Description
	 Confirmation of the calculated data. A report with the calculated data is displayed.
11.	Tap <b>Accept setup</b> to confirm set data and complete the procedure.
12.	The instrument relocks to the prism automatically after the free station results have been accepted.

### Open free station

Step	Description
	 The procedure of the station setup in Free station mode can be completed at later time, during the survey operation. However, it is good practice to complete the procedure before starting the point survey, with X-PAD it is not mandatory. The possibility to leave the free station open, allows to measure the control points when in their proximity, without necessarily having to measure all the control points which could also be very far from each other.
1.	The free station setup requires the measurement of at least two control points. The software asks if you want to proceed with the measurement of control points.. Tap <b>NOT NOW</b> to postpone the measurement of the control points to a later step.
2.	Starting the free station without measuring any control points: The station assumes arbitrary local coordinates and no orientation. If only one control point has been measured: The station assumes local coordinates with respect to the control point but without any orientation. If two or more control points have been measured: The station can already have a correct position and orientation.
3.	To add new control points to a free station which has been left open: Click on the station data panel to go back to the command <b>Survey points</b> of the station setup procedure. After adding a new control point to the free station: <ul style="list-style-type: none"> <li>The position and the orientation of the station are recalculated.</li> <li>The position of all the points previously measured by the station is recalculated.</li> </ul>

### Free station 3D

The orientation mode **Free station 3D** defines the position and orientation of station based on measurements of three or more reference point. The calculation is based on a 3D transformation instead of a separate coordinate and elevation calculation.

The procedure is similar to the one for a normal free station.

### Auto free station

Available for robotic total stations.

The orientation mode **Auto Free station** performs an automatic search and automatic measurement of all targets around the station. The measurements are compared with the coordinates of the reference points, which must have been added to the job previously. Then, the software calculates the position and orientation of the station.

## Reference axis

Step	Description
1.	Define the station. <ul style="list-style-type: none"> <li>• <b>Station</b> Name of the station. A new name must be defined.</li> <li>• <b>Instrument height</b> Elevation of the total station from the ground. It is possible to calculate the height of the instrument in different ways, refer to <a href="#">Description</a>. To access the options tap &gt;.</li> <li>• <b>Code</b> Code to assign to the station point in case a new point is created.</li> </ul>
2.	Tap <b>Next</b> to proceed with the guided procedure.
3.	Enter the coordinates of the point of origin of the reference axis. OR Tap <b>Select</b> to choose a stored point. OR Tap <b>Measure</b> to measure a new reference point..
4.	Aim at the point of origin of the reference axis ( <b>REFAXIS-ORIGIN</b> ).
5.	Tap <b>Measure</b> .
6.	Aim at the point that sets the direction of the reference axis (X axis) ( <b>REFAXIS-DIRECTION</b> ).
7.	Tap <b>Measure</b> .
8.	Displayed is the calculated axis length.
9.	Tap <b>Accept setup</b> to complete the procedure.

## Two reference axes

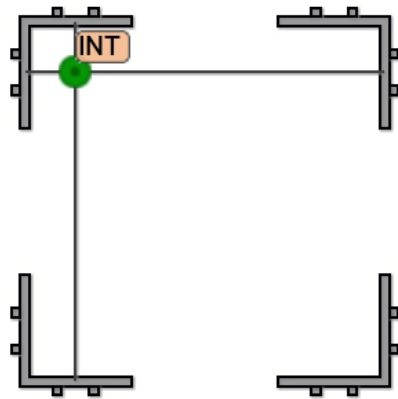

Step	Description
1.	Tap <b>Measure</b> to measure the two points, which define the first reference axis.
2.	Tap <b>Measure</b> to measure the two points, which define the second reference axis.
3.	Tap <b>Select</b> to choose the first reference line from the graphic window.
4.	Choose the second reference line from the graphic window.
5.	The two possible solutions for the position of the station are proposed.
6.	Click on the correct solution.
7.	Tap <b>Save</b> .
8.	The procedure ends with storing the position and orientation of the station.

## Batter boards

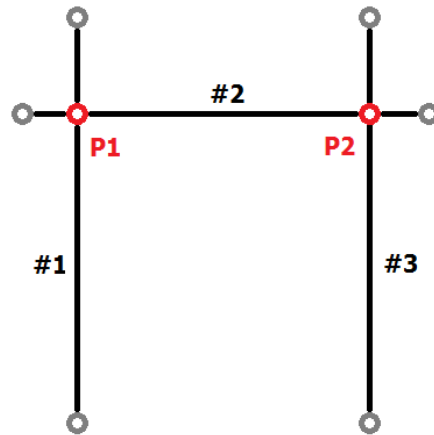

- P1 Unavailable on site, coordinates available in the job
- P2 Unavailable on site, coordinates available in the job
- #1 First reference line
- #2 Second reference line
- #3 Third reference line

Step	Description
1.	Tap <b>Measure</b> to measure the two points, which define the first reference axis.
2.	Tap <b>Measure</b> to measure the two points, which define the second reference axis.
3.	Tap <b>Measure</b> to measure the two points, which define the third reference axis.
4.	The measured lines are displayed in the graphic window.

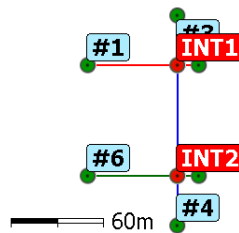

5.	Tap <b>Select</b> to choose the point that corresponds to <b>INT1</b> shown in the graphic above.
6.	Tap <b>Select</b> to choose the point that corresponds to <b>INT2</b> shown in the graphic above.

## No orientation step-by-step

Step	Description
1.	Define the station. <ul style="list-style-type: none"> <li>• <b>Station</b> Name of the station. Select a point existing in the job or create a point.</li> <li>• <b>Instrument height</b> Elevation of the total station from the ground. It is possible to calculate the height of the instrument in different ways, refer to <a href="#">Description</a>. To access the options tap &gt;.</li> <li>• <b>Code</b> Code to assign to the station point in case a new point is created.</li> <li>• <b>E, N, Z</b> Coordinates of the station. When an existing point was selected, the values cannot be edited.</li> </ul>
2.	Tap <b>Accept setup</b> to confirm set data and complete procedure.

## Tools of the orientation

### Checking the orientation

To check if the orientation of the station is still valid or if the orientation must be done again.

Step	Description
1.	Tap <b>Check orientation</b> in the window <b>Station setup</b> .
2.	Aim at the orientation point.
3.	A report with the difference is displayed.
4.	Tap <b>Continue</b> .
5.	The software asks if this measurement should be used as a new backsight orientation for subsequent measurements. It is also possible to adjust all previous measurements with the new setting.

### Changing the height of the station

Step	Description
1.	Tap <b>Set instr. height</b> in the window <b>Station setup</b> .
2.	Change the instrument height of all station measurements.
3.	The elevations of all measured points is recalculate.

### Resetting the station elevation

Step	Description
1.	Tap <b>Reset</b> in the window <b>Station setup</b> . The button is in the part of the window which shows the coordinates of the station.
2.	The value for the station elevation is set to the previous elevation.

### Setting the elevation of the station from reference point

Step	Description
	The elevation of a station can be calculated by measuring one or more reference points.
1.	Tap <b>From a single point</b> in the window <b>Station setup</b> . The button is in the part of the window which shows the coordinates of the station.

#### Setting the elevation from a single point

2. Select the reference value to perform the calculation and take the measurement.
  - **Reference value**  
Select if the point or the elevation is used as reference value.
  - **Point**  
Select a point from the job. The point is used as reference for the calculation of the station elevation.
  - **Elevation**  
Enter the elevation of the reference point.

#### Setting the elevation from multiple points

3. Select the reference point, aim at the point and measure it.
4. Tap **Add point** to add more reference points.

**Description**

This chapter explains commands for measuring points with the mechanic or robotic total station.

Step	Description
1.	Tap <b>SURVEY</b> .
2.	Tap <b>Survey points</b> .

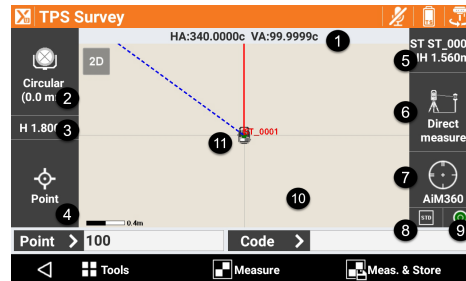

Refer to the table below for an explanation of the legend numbers.

The toolbar at the bottom provides access to a menu of advanced functions and to commands for measuring points.

The required data for recording points is:

- **Point**  
Name of the point to measure. In tracking mode, the name can be changed while measuring.
- **Code**  
Code to assign to the point to measure

Legend	Type	Description
1.	Angles	The current angles of the total station.
2.	Current target	The type of current target. Click on the panel to edit the type of target. Refer <a href="#">Setting the target type</a> .
3.	Elevation of the target	Elevation of the target. Click to modify the elevation.
4.	Smart Drawing – Drawing during survey	Displays the current status of the function Smart Drawing. Click to select a tool for drawing or the operation to perform. Refer to <a href="#">11.7 Smart Drawing - Drawing During Survey</a> .
5.	Current station	Name and elevation of the current station. Click to access a window that allows changing the orientation of the station. Refer <a href="#">17 TPS - Station Setup</a> .

6.	Measuring mode	Visualises the measure mode.
----	----------------	------------------------------



**Direct measure**

Measure directly to a point.

**Traverse Point**

Specifies that the next point measured is a polygonal point. The polygonal points are saved to allow a rapid change of station.



**Offset HA**

Performs a measurement to an object for which the prism cannot be placed at the point to measure.









**Offset VA**

Performs a measurement to a point not accessible directly by the prism but above or below.



**Offset Distance**

Performs a measurement to a point not accessible directly by the prism but at a certain distance along the direction between station and prism.

Legend	Type	Description
		<b>Face1/Face2</b> Performs a measurement to a point in both faces and calculates the average.
		<b>Only HA</b> Performs only an angle measurement to a point.
		<b>Multi target</b> Performs a measurement using a multi target pole.
7.	Status of locking of the prism (robotic station)	 Prism is unlocked. Tap to lock the prism.   Prism is locked. Tap to unlock the prism.   Automatic aiming of prism is deactivated. Tap to activate the automatic aiming.
8.	Setup station (mechanic station)	Click to access a window that allows managing the parameters for the functioning of the mechanic total station.
9.	Mode of measure	The current measurement mode: <b>Standard, Fast, Tracking</b> (continuous measure) When working in <b>Tracking</b> mode, these actions are possible while measuring without stopping the measurement. <ul style="list-style-type: none"> <li>• Changing the target height</li> <li>• Measure and store points with additional offset value. Switch from standard measurement mode to offset distance</li> </ul>
10.	Status of the bubble	The symbol in red indicates that the instrument is out of bubble.
11.	Graphic area	Graphic view with visualisation of survey and drawing. Click twice in the graphic part to access the main CAD window.
12.	Current position	Indicates the current position. Blue: All parameters of operation satisfy the preset level of accuracy. Red: The accuracy parameters are not met.

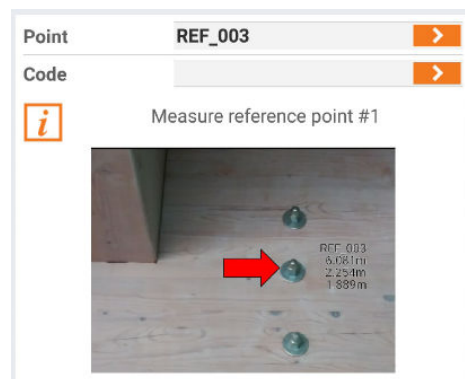



For the TPS orientation, it is required to measure one or more reference points. If a reference point has been stored with a photo, the photo is displayed as an aid to identify and measure the correct point.





### Automatic updating of the view

If remote control of the instrument is enabled, use  to show the direction from the pole to the station.

### Rapid measuring of points step-by-step

Step	Description
1.	Tap  .
2.	The point measurement starts. the point is saved automatically.
3.	Tap  to stop measuring.
4.	If GIS feature are required for a point code, a window for entering the attributes opens.



### Measuring points step-by-step





Step	Description
1.	Tap  .
2.	Measure the target.
3.	Decide if the point will be recorded. The angle measured to an inaccessible point can be edited.
4.	Tap  to stop measuring.
5.	Tap  to save the measurement and to display the data.
6.	If GIS feature are required for a point code, a window for entering the attributes opens.

### Data page

Field	Description
<b>Point</b>	Name of the point to store
<b>Target height</b>	Prism height at the moment of the acquisition of the point When working in <b>Tracking</b> mode, the target height can be changed while measuring without stopping the measurement.  Select the last used and target heights from a list. The list is generated by the software and stores the last used heights.
<b>Code</b>	Code assigned to the point. Refer to <a href="#">11.4 Survey Code Assignment</a> and <a href="#">11.5 Quick Codes</a> .
<b>Description</b>	Extended description associated to the point

### Sketch page

Icon	Description
	Deletes sketch and photo.
	Restores original content
	Adds a label with main information of the point. The label can be moved in every position.





Icon	Description
	Adds a label with a free text. The label can be moved in every position.
	Adds an arrow symbol. The arrow can be moved and turned.
	Enables the free drawing mode.
	Starts the application allowing to shoot a photo and save it.

### Result page

General information about the point to record.

### Measuring traverse points step-by-step

With this option activated, the next point measured is saved as a traverse point.

Step	Description
	Activate this option before measuring points that are used as the next stations.
1.	Tap  .
2.	Tap <b>Traverse Point</b> .
3.	When changing the station, click the panel that reports data of the current station (name and elevation).
4.	Before changing to the window of the station orientation, decide to setup the instrument one of the traverse points measured previously.
5.	Select the traverse point of the station setup.
6.	The software starts directly the procedure for the station orientation. The selected traverse point is used as station and the previous station as point of orientation.
	After the traverse point has been measured, the option <b>Traverse Point</b> is deactivated. Repeat the setting for the next polygonal point.
	The measurements are analysed, the type of traverse is defined (closed, closed-loop or open) and errors are calculated (linear and angular). Errors can be distributed along the traverse and the measured points can be recalculated.

### Measuring points with horizontal angle offset step-by-step

With this option activated, measure the position of the prism when it cannot be measured at the exact position.

When working in **Tracking** mode, measure and store points with additional offset value while measuring without stopping the measurement. Switch from standard measurement mode to offset distance.

Step	Description
1.	Tap  .
2.	Tap <b>Offset HA</b> .
3.	Position the prism at the side of the object to measure where it would normally be measured.
4.	Aim the center of the object.
5.	Measure.

Step	Description
6.	Stored is: <ul style="list-style-type: none"> <li>The measurement of the horizontal angle to the center of the object</li> <li>The distance measured to the prism</li> </ul>

### Measuring points with vertical angle offset step-by-step



With this option activated, measure the position of a point that is on the vertical line of the prism but cannot be reached by the prism itself.

When working in **Tracking** mode, measure and store points with additional offset value while measuring without stopping the measurement. Switch from standard measurement mode to offset distance.

Step	Description
1.	Tap  .
2.	Tap <b>Offset VA</b> .
3.	Position the prism vertically above or below the object to measure where it would normally be measured.
4.	Measure.
5.	Aim the center of the object.
6.	Record the measurement.
7.	Stored is: <ul style="list-style-type: none"> <li>The measurement of the vertical angle to the center of the object</li> <li>The distance measured to the prism</li> </ul>

### Measuring points with distance offset step-by-step

With this option activated, measure the position of a point not accessible directly by the prism but at a certain distance along the direction between station and prism.

Step	Description
1.	Tap  .
2.	Tap <b>Offset Distance</b> .
3.	Position the prism in a visible and measurable position from the total station
4.	Measure.
5.	Enter the offset values: <ul style="list-style-type: none"> <li><b>Forward/Back</b> Distance along the direction from station to prism</li> <li><b>Right/Left</b> Lateral offset referring to direction from station to prism</li> <li><b>Up/Down</b> Slope difference referring to position of the prism</li> </ul>  Directions <b>Forward/Back</b> and <b>Right/Left</b> have to be considered opposite when working in remote mode (controller on the pole).
6.	Record the measurement.

### Measuring points in face 1 and face 2 step-by-step

With this option activated, measure the position of a point in both faces and calculates the average.

Step	Description
1.	Tap  .
2.	Tap <b>Face1/Face2</b> .
3.	Measure the point in both faces.
4.	If the values of the two measurements differ more than the defined tolerance, a warning message appears.
5.	Record the measurement.

### Measuring points with angle only step-by-step

With this option activated, measure the values of the horizontal and vertical angle.

Step	Description
1.	Tap  .
2.	Tap <b>Only HA</b> .
3.	Measure the angles.
4.	Record the measurement.
5.	Since the distance is missing, the coordinates of the point cannot be calculated and the point cannot be visualised.

### Measuring points with multi target pole step-by-step

The multi target pole is a special pole to measure in situations where there are two or more targets such as prisms or tapes. The multi target pole is used to detect the invisible points and where the pole cannot be hold vertically. The measurement of at least two targets allows to calculate the three-dimensional position of the point.

Step	Description
1.	Tap  .
2.	Tap <b>Multi target</b> .
3.	Tap <b>Measure</b> to access the window for pole measurement with multiple targets.

#### Setting the pole parameters

4.	Tap  .
5.	Tap <b>Pole setup</b> .
6.	Define: <ul style="list-style-type: none"> <li>• <b>Length (H)</b> Total pole length</li> <li>• <b>Num. target</b> Number of targets present</li> <li>• <b>Dist. between target (h)</b> Distance between targets</li> <li>• <b>Calculation tolerance</b> Tolerance to use to accept the calculation</li> </ul>

#### Measuring the targets

7.	Select the number of targets to measure.
8.	Aim at the first target.
9.	Tap <b>Measure</b> to measure the angles.
10.	Repeat for the second target.
11.	A table is displayed showing the results of the calculation and the errors of each measurement.



Adds the measurement of a further target



Saves the measures and stores the point

### Measuring points with X-Tilt for TPS

Measure an inaccessible point by inclining the pole in two directions and measuring the corresponding position. The position of the point is automatically calculated.

Field	Description
<b>E-Bubble (X-TILT)</b>	Exploiting the internal inclinometer, an electronic bubble is displayed directly on the screen. The operator can keep the attention on the display instead of constantly looking at the controller and the physical bubble placed on the pole. Moreover, the software is able to prevent the acquisition of measurements when the pole is located outside the bubble condition.

Field	Description
-------	-------------

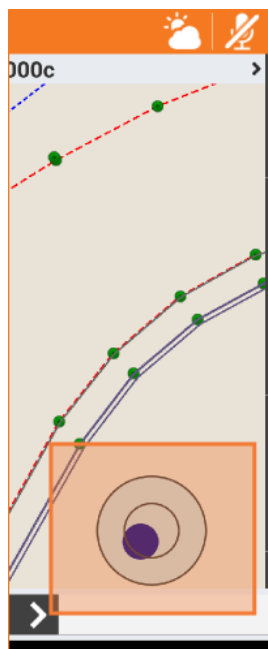

<b>Dual</b>	Exploiting the internal inclinometer, a double measurement of the point with inclined pole (up to and beyond 30°) can be done and determine the position of the point. This mode requires no system calibration and is not sensitive to external factors. The measurement of points runs automatically.
<b>Single</b>	Exploiting the internal inclinometer and the internal compass the system is able to determine the three-dimensional position and direction of the pole and to calculate the coordinates of the point on the ground even when the pole is inclined (up to 15 °). The system requires the compass calibration and may be subject to external factors such as magnetic fields generated by the elements present on the site to be surveyed. For more information on the calibration mode and the operating procedures to be followed in the field, see the documentation supplied with the receiver. To measure points with <b>Single</b> mode activate the <b>Tilted pole (X-TILT)</b> option. Before using this mode it is necessary that a calibration of the internal compass has been executed.



### Electronic bubble

Step	Description
1.	Tap  .
2.	Tap <b>Survey settings</b> .
3.	Tap <b>TPS</b> page.
4.	Tap <b>Accuracy check</b> .
5.	For <b>Sensors mode</b> , select <b>E-bubble (GNSS receiver)</b> .
6.	In the survey and stakeout windows, the bubble is displayed. During the phases of acquisition of the position, if the inclination of the pole is higher than the set tolerance, the position is not acquired.
7.	Click the electronic bubble, to disable the use of the bubble, enable the calibration or switch to <b>Single</b> mode.

### Dual mode

This measuring mode allows measuring points without having to keep the pole vertical. It requires two inclined measurements in two directions while keeping the tip of the pole on the point.

The measurement of points runs automatically.

Step	Description
1.	Tap  .
2.	Tap <b>Hidden point</b> .
3.	Tap <b>Tilted pole</b> .
4.	First measurement Place the tip of the pole on the point to measure. Tilt the pole to a position that allows the receiver to fix the position. Do not go beyond 30 to 40°. Stay stable to acquire the first position automatically.
5.	Second measurement Keep the tip of the pole on the point and the pole inclined rotate around the point. A circle appears on the map representing the first measurement and a second circle representing the second measure. Act so that the two circles have an overlapping zone and two points of intersection. Stay stable until the second position is acquired.
6.	Third measurement If necessary or to improve the accuracy of the calculated data, perform a third measure always with the previous modes.
7.	Calculation The intersections of the two circles are calculated. Bring back slightly the pole in a vertical direction to allow the software to automatically select the intersection related to measured point.
	During this procedure it is not necessary to press any button.

#### Single mode

Step	Description
1.	Tap  .
2.	Tap <b>Survey settings</b> .
3.	Tap <b>TPS</b> page.
4.	Tap <b>Sensors mode</b> .
5.	Select <b>Tilted pole (X-TILT)</b> . In the survey and stakeout windows, the bubble is displayed. If the calibration is correct, the calculated position is always the position of the point on the ground at any angle (up to 15°).
6.	Click the electronic bubble, to disable the use of the bubble, enable the calibration or switch to <b>Dual</b> mode.

#### Measuring points with prism offsets step-by-step

Measure walls and corners with TPS and prisms in a single step.

Step	Description
1.	Activate <b>Measure with prism offsets</b> .
2.	Verify that the correct prism is selected.
3.	In the new bar, tap on the corresponding offset to apply: <ul style="list-style-type: none"> <li>• <b>STD</b> Offset is not applied, standard measurement</li> <li>• <b>LEFT</b> Prism is to the left of the point</li> <li>• <b>RIGHT</b> Prism is to the right of the point</li> <li>• <b>LONG</b> Point is in the direction from TPS to prism</li> <li>• <b>DOWN</b> Point is measured with prism upside-down</li> </ul>
4.	Tap <b>Measure</b> or <b>Measure &amp; Save</b> to record the point, applying the selected offset.

# 19

## TPS - Stakeout

### Description

Stakeout procedures provide information in graphic, numeric and vocal format, to reach a point, an element or in general a particular position. A wide range of options and operative modes are available.

Before proceeding with stakeout, it is necessary to define the precise orientation of the station in order to guarantee the correct matching between surveyed positions and positions to stakeout.

### 19.1

### Stakeout Information

### Description



Information provided by the software during stakeout of a position is similar in all modes. Whether staking out a point, an element or a position by offset, the software provides indications to reach the position to stakeout using a common scheme.

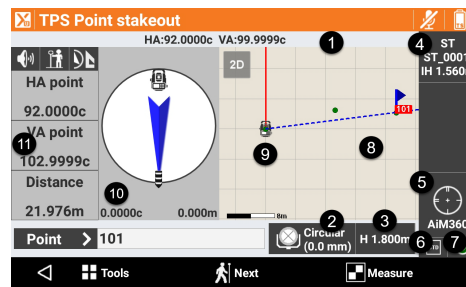

Step	Description
1.	Tap <b>SURVEY</b> .
2.	Tap <b>STAKEOUT</b> .



Refer to the table below for an explanation of the legend numbers.

The toolbar at the bottom provides access to a menu of advanced functions and to commands for measuring points.

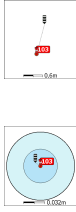
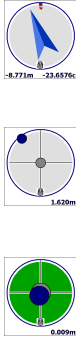
Legend	Type	Description
1.	Angles	The current horizontal angle of the total station
2.	Current target	The type of current target. Click to edit the type of target. Refer to <a href="#">Setting the target type</a> .
3.	Elevation of target	Elevation of the target. Click to modify the elevation.
4.	Current station	Name and elevation of current station.
5.	Status of locking of the prism (robotic station)	<div style="display: flex; align-items: center;">            Prism is unlocked. Tap to lock the prism.         </div> <div style="display: flex; align-items: center; margin-top: 10px;">            Prism is locked. Tap to unlock the prism.         </div>
6.	Setting station (mechanic station)	Click to manage the parameters of how the mechanic total station works.
7.	Mode of measure	The current measurement mode: <b>Standard</b> , <b>Fast</b> , <b>Tracking</b> (continuous measure) When working in <b>Tracking</b> mode, these actions are possible while measuring without stopping the measurement. <ul style="list-style-type: none"> <li>Storing a stakeout point</li> </ul>
8.	Status of the bubble	The symbol in red indicates that the instrument is out of bubble.

Legend	Type	Description
9.	Graphic area	Graphic view with visualisation of survey and drawing. 
10.	Station position	Indicates the current position. Blue: All parameters of operation satisfy the preset level of accuracy. Red: The accuracy parameters are not met.
11.	Current direction	This panel shows the current direction of the total station referring to direction of the stakeout point. Rotate the station toward the stakeout position. In the lower part is the distance in meters and the difference in angle to the point Blue: When more than a meter distance from the position to reach  When a measurement is done, the position of the target referring to the station and referring to the stakeout position is displayed. In the lower part, the distance between the target and the stakeout position is indicated.  The background becomes green, when the position is reached within the tolerance values. 
12.	Numeric indications to reach position	Indications refer to the station toward the target or from the target toward the station. First value refers to distance <b>Forward/Back</b> . Second value refers to distance <b>Right/Left</b> . Third value specifies the elevation difference. 



When working with remote control with the controller on the pole, previous data are visualised in the opposite direction. The operator is looking at the station.

### Stakeout tolerance





A position is reached when the distance between the current position and the position to reach is less or the same as **Tolerance**. The **stakeout tolerance** is set in the Stakeout settings. From every stakeout procedure it is possible to enter in the stakeout parameters and to check tolerance value.

### Information referring to North, the sun or to a reference point

The information provided in the panel on the right refer to the position of target, the total station, North or a reference point. Click a button to change the reference element.



Icon	Description
	Position of the target From position of the target look with the controller toward the total station



Icon	Description
	Total station From the total station look toward the target.
	North Look with the controller toward North.
	Reference point Look with the controller toward the reference point.
	Change to previous measured point
	Change to reference line.



### Graphic and analytic view

Buttons allow to change between analytic and graphic view.

Icon	Description
	Enables the view of analytical mode only, which indicates the distance from the point.
	Enables the graphic window display.
	Enables the mixed display that shows distance from the point and the graphical window.

### Vocal information



The software guides by vocal information allowing, most of all when you are far from the point, to arrive near the point without having to look always on the controller. A tone tells when the desired position is reached considering the defined tolerance limits.

Icon	Description
	Enables vocal information.
	Disables vocal information.

## 19.2

### Common Operations in Stakeout

#### Measuring points step-by-step

Step	Description
1.	Reach the stakeout position with the prism.
2.	Tap  <b>Measure</b> to start measuring the stakeout point.
3.	Tap  <b>Accept</b> to record the point when the stakeout position is reached. When working in tracking mode, accepting and storing can be done without interrupting the tracking procedure. Refer to <a href="#">Stakeout parameters step-by-step</a> for information about accuracy check.

Step	Description
4.	When the number of defined epochs is reached, confirm the stakeout data displayed.
5.	Tap <b>Next</b> to proceed and define the data of the point to record.
6.	Stakeout data are saved. If required, export the data from window <b>Stakeout results</b> .
7.	The next point to stakeout is automatically proposed by the software.

#### Stakeout parameters step-by-step

Step	Description
1.	Tap  .
2.	Tap <b>Survey settings</b> .
3.	Tap <b>Stakeout</b> .
4.	Refer to <a href="#">Tab Stakeout</a> for a description of the options.
5.	Tap <b>Accept</b> to save the modifications.
6.	When working in <b>Tracking</b> mode, the current measured position can be stored without the need to stop the measurement. As soon as the point is stored it is possible to stake out the next one.

#### Turning toward point step-by-step

Step	Description
1.	Tap  .
2.	Tap <b>Turn towards point</b> .
3.	The motorised instrument turns automatically toward the direction of the point to stake.

#### Inserting a note step-by-step

Step	Description
1.	Tap  .
2.	Tap <b>Add note</b> .
3.	Add to the fieldbook: <ul style="list-style-type: none"> <li>• Measurements</li> <li>• Descriptive notes</li> <li>• Sketches that can be a valid reference at the moment of elaborating the measured data in the office</li> </ul>

#### Points and measurements step-by-step

Step	Description
1.	Tap  .
2.	Tap <b>Points &amp; Measurements</b> .
3.	Refer to <a href="#">Points</a> , <a href="#">Measurements</a> , <a href="#">Survey Codes</a> and <a href="#">GIS Features Management</a> .

#### Showing up and down target buttons step-by-step

Step	Description
1.	Tap  .
2.	Tap <b>Show up/down target buttons</b> .
3.	Two buttons are displayed at the bottom of the screen. In reflectorless measurement mode, the buttons help to find the position on the ground when the real position is covered by material. The buttons allow to move up and down the height of the target in order to determine the correct position of the point above the material. In this case, the stacking out concerns the X and Y coordinates but not the elevation.
4.	Click a button once to change the height of the target by 1 cm. Click and hold the button longer to change the height by 10 cm.

Step	Description
5.	Every time the height is changed, the vertical angle of the station is corrected accordingly.

## 19.3

### Staking out points step-by-step

### Stakeout

Define the mode how to reach the position. The software guides to the position in the most efficient way.

Step	Description
1.	Tap <b>STAKEOUT</b> .
2.	Tap <b>Points</b> .
3.	Select a mode: <ul style="list-style-type: none"> <li>• <b>Point from CAD</b> Select the point to stake directly from the graphic window.</li> <li>• <b>Point from Table</b> Select the point to stake from a list of points.</li> <li>• <b>Automatic by position</b> The nearest point to stake out is selected automatically according to position of the prism pole.</li> <li>• <b>Define points list</b> Create a list of topographic points to stake.</li> <li>• <b>Coordinates</b> Manual definition of East, North and elevation to stake. Coordinates can be selected from the CAD drawing.</li> </ul>

#### Stakeout of points from a table

4. Select a point from the list.  
The icon beside the point indicates if the point is to stake or already staked.



Point that must be staked.



Point already staked.

5.	Tap  <b>Tools</b> for operations in the list.
6.	Select an operation: <ul style="list-style-type: none"> <li>• <b>Load all points</b> Adds all topographic points from the job to the list.</li> <li>• <b>Select from table</b> Select topographic points from the job to add to the list.</li> <li>• <b>Select from CAD</b> Select topographic points in the graphic window to add to the list.</li> <li>• <b>Delete points</b> Select points from the list to delete.</li> <li>• <b>Clear list</b> Deletes content of the list.</li> <li>• <b>Load list from file</b> Load a list of points from a file saved previously.</li> <li>• <b>Save list to file</b> Saves the list of points on an external file to be loaded later.</li> <li>• <b>Delete points</b> Deletes the content of the list.</li> <li>• <b>Load all points</b> Loads all topographic points from the job into the list.</li> </ul>

#### Stakeout of ENZ coordinates

7.	<b>E, N, Z</b> Enter the coordinates of the position to stake.
8.	Tap <b>Select</b> to define coordinates by selecting from the graphic window.

#### Stakeout procedure

9. After having defined the position to stake, the main stakeout window appears.

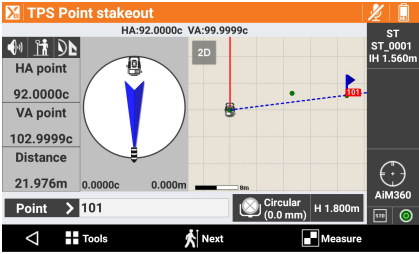
Step	Description
	 <p>The preferred layout of the stakeout screen is stored and used in all jobs until it is changed.</p>

Stakeout of the next point	
10.	Select another object to stakeout by selecting it on the current graphic view. OR Tap <b>Next</b> .
11.	Select the next point to stake in one of the following modes: <ul style="list-style-type: none"> <li><b>Next</b> The next point is suggested, according to recording order.</li> <li><b>Previous</b> The previous point is suggested, according to recording order.</li> <li><b>Nearest</b> The nearest point, which has not been staked yet, is suggested.</li> <li><b>Select from CAD</b> Manual selection of the point to stake in the graphic window.</li> <li><b>Select from table</b> Manual selection of the point to stake from the table.</li> </ul>

**Staking out lines/arcs/objects step-by-step**

Stake out with precision along geometric elements such as lines, arcs or drawing elements.

Step	Description
1.	Tap <b>STAKEOUT</b> .
2.	Tap <b>Objects</b> .
3.	Select a mode: <ul style="list-style-type: none"> <li><b>Line (2 points)</b> Line defined by two topographic points.</li> <li><b>Arc (3 points)</b> Arc defined by three topographic points.</li> <li><b>Arc (2 points+R)</b> Arc defined by two topographic points and by the radius.</li> <li><b>Drawing object</b> Select a line, polyline, arc or circle in the graphic window.</li> </ul>

Stakeout a line by two points	
4.	Select: <ul style="list-style-type: none"> <li><b>Point 1</b> First point of the reference line</li> <li><b>Point 2</b> Second point of the reference line</li> <li><b>Invert</b> Inverts the direction of the line.</li> <li><b>Info...</b> Shows the information of the object.</li> </ul>

Stakeout of arc by three points	
5.	Select: <ul style="list-style-type: none"> <li><b>Point 1</b> First point of the reference arc</li> <li><b>Point 2</b> Second point of the reference arc</li> <li><b>Point 3</b> Third point of the reference arc</li> <li><b>Invert</b> Inverts the direction of the line.</li> <li><b>Info...</b> Shows the information of the object.</li> </ul>

Step	Description
------	-------------

**Stakeout of arc by two points and radius**

6. Select:
  - **Point 1**  
Starting point of the reference arc
  - **Point 2**  
Ending point of the reference arc
  - **Radius**  
Radius of the reference arc
  - **Arc clockwise**  
Direction of the reference arc
  - **Invert**  
Inverts the direction of the line.
  - **Info...**  
Shows the information of the object.

**Stakeout of CAD element**

7. Select the drawing element to stake from the graphic window.

**Offset**

8. After defining the stakeout element, an additional offset to the right or to the left can be defined.
  - **Offset**  
Distance to observe referring to reference element
  - **Height diff.**  
Vertical offset. Start from a reference object and apply a 3D offset.
  - **Multiplier**  
Activates the stakeout of multiple offsets according to the set value of reference offset. When the option is active, the software shows the distance from the nearest offset and displays the multiplication factor of the offset distance.

**Stakeout procedure**

9. After having defined the position to stake, the main stakeout window appears.

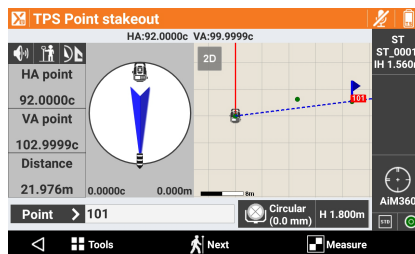

Information of stakeout:



Current position is on the left referring to the reference element.



Current position is on the right referring to the reference element.



Current position is on the reference element.

Icon



To visualise the distance from the end of the object.

## Staking out station and offset step-by-step

Step	Description
	 To visualise the distance from the beginning of the object.
Stake out positions referring to a station distance and an offset distance on a reference element.	
Step	Description
1.	Tap <b>STAKEOUT</b> .
2.	Tap <b>Chainage &amp; offset</b> .
3.	Select a mode: <ul style="list-style-type: none"><li>• <b>Line (2 points)</b> Line defined by two topographic points.</li><li>• <b>Arc (3 points)</b> Arc defined by three topographic points.</li><li>• <b>Arc (2 points+R)</b> Arc defined by two topographic points and by the radius.</li><li>• <b>Drawing object</b> Select a line, polyline, arc or circle in the graphic window.</li></ul>
Stakeout by offset referring to a line by two points	
4.	Select: <ul style="list-style-type: none"><li>• <b>Point 1</b> First point of the reference line</li><li>• <b>Point 2</b> Second point of the reference line</li><li>• <b>Invert</b> Inverts the direction of the line.</li><li>• <b>Info...</b> Shows the information of the object.</li></ul>
Stakeout by offset referring to an arc by three points	
5.	Select: <ul style="list-style-type: none"><li>• <b>Point 1</b> First point of the reference arc</li><li>• <b>Point 2</b> Second point of the reference arc</li><li>• <b>Point 3</b> Third point of the reference arc</li><li>• <b>Invert</b> Inverts the direction of the line.</li><li>• <b>Info...</b> Shows the information of the object.</li></ul>
Stakeout by offset referring to an arc by two points and radius	
6.	Select: <ul style="list-style-type: none"><li>• <b>Point 1</b> Starting point of the reference arc</li><li>• <b>Point 2</b> Ending point of the reference arc</li><li>• <b>Radius</b> Radius of the reference arc</li><li>• <b>Arc clockwise</b> Direction of the reference arc</li><li>• <b>Invert</b> Inverts the direction of the line.</li><li>• <b>Info...</b> Shows the information of the object.</li></ul>
Stakeout by offset referring to a CAD element	
7.	Select the drawing element to stake from the graphic window.
Offset parameters	

Step	Description
8.	Define: <ul style="list-style-type: none"> <li>• <b>Chainage</b> Distance on the reference element on which is the position to reach.</li> <li>• <b>Interval</b> Distance between the stakeout points along the reference element. Use the button on the right to calculate the interval dividing the length of the reference element in a defined number of parts.</li> <li>• <b>Offset</b> Distance perpendicular to the reference element. Use the button on the right to define if the desired position is on the right or on the left of the reference element.</li> <li>• <b>Height diff.</b> Elevation difference to apply to the calculated point. The software interpolates the elevation on the reference element with the defined station distance. A slope can be added to the interpolated elevation.</li> <li>• <b>Use vertices</b> Option to stakeout vertexes of the object (start point, end point, intermediate vertexes).</li> </ul>
9.	Tap <b>Next</b> to start staking out of the calculated position.

### Stakeout procedure

10. After having defined the reference element and the offset parameters, the main stakeout window appears. The distance from the station and the offset of the position are displayed at the bottom. When staking with offset, change the distance and the offset directly in the stakeout window.

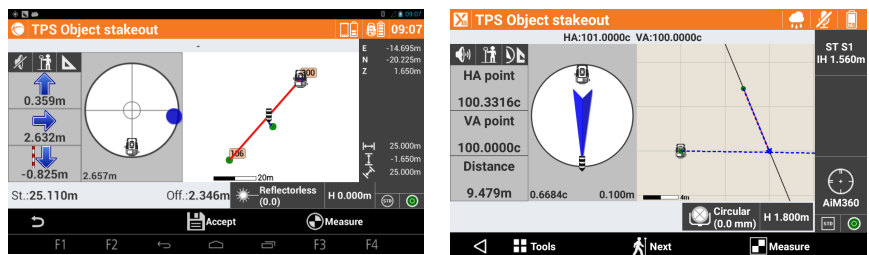

11. Select another object to stakeout by selecting it on the current graphic view.  
OR  
Tap **Next** to stake out the next point.  
The procedure returns to the panel where the station distance and the offset are defined. A station distance increased of the interval value is suggested.
-  Changing the offset can also be done directly in the stakeout window without going back to the previous window.

### Staking out side slopes step-by-step

Calculate and stake out positions of the point of intersection of the project side slope with the existing terrain.

The stakeout position is calculated from the following information:

- From the point position to the projection of the slope
- Distance to the stakeout element

Step	Description
1.	Tap <b>STAKEOUT</b> .
2.	Tap <b>Sideslopes</b> .
3.	The requests that are performed are exactly the same as for stakeout by offset. Refer to <a href="#">Staking out station and offset step-by-step</a> . A tab for the definition of the slopes is added.

### Slopes



Step	Description
4.	Define: <ul style="list-style-type: none"> <li>• <b>Cut</b> Slope value in the cut condition (receiver elevation above the starting elevation of the slope).</li> <li>• <b>Fill</b> Slope value in the fill condition (receiver elevation under the starting elevation of the slope).</li> </ul>

5. Tap **Next** to start staking out of the calculated position.

#### Stakeout procedure

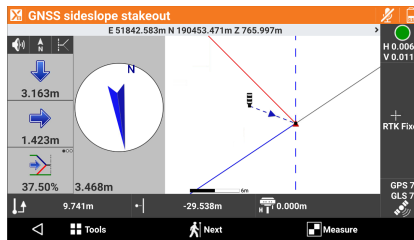
6. After having defined the reference element, the offset parameters and slopes, the main stakeout window appears.



In addition to the visualisation mode described in previous paragraphs, this graphical view contains the cross section of the side slope and current position. To change the visualisation mode tap the icons , , and .



The side panel contains the information to get the point of intersection. First value refers to the vertical distance from the position to side slope. Second value refers to the horizontal distance from the position to side slope. Third value shows the current value of the slope and the direction to take, on the perpendicular to the reference element, to achieve the project slope value. It is possible to change the shown information: hit it or scroll.

### Staking out side slopes for excavation step-by-step

Stakeout side slopes that start from a closed polyline and that represent, for example, the bottom of an excavation.

- Finding the catch point with the existing ground
- Checking side slopes created by the excavator

Step	Description
1.	Tap <b>STAKEOUT</b> .
2.	Tap <b>Sideslopes automatic</b> .
3.	The requests that are performed are exactly the same as for stakeout by offset. Refer to <a href="#">Staking out station and offset step-by-step</a> . Select the polyline. A tab for the definition of the slopes is added.

#### Slopes

4. Define:

- **Offset**  
Horizontal distance from the position to side slope.
- **Slope**  
Slope between the polyline and the current position
- **Ref. elevation**  
Sets the reference elevation to use for the elevation check.



Step	Description
------	-------------

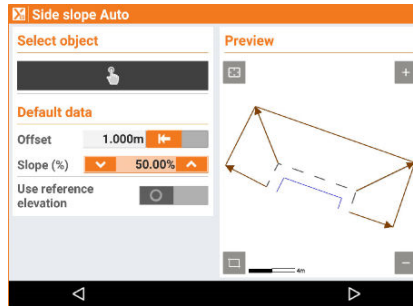

5. Tap **Next**.

### Stakeout procedure

6. The position along the side slope is calculated and displayed.

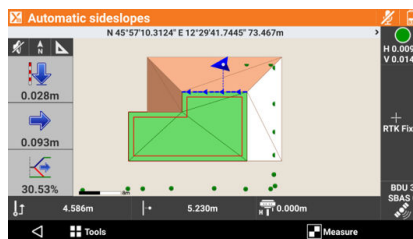

First value refers to the current elevation below or above the reference elevation. Second value refers to the horizontal distance from the position to side slope. Third value shows the current value of the slope and the direction to take, on the perpendicular to the reference element, to achieve the project slope value.

### Stake out surfaces step-by-step

Determine in the field the design elevation of a three-dimensional surfaces loaded in current job. For every position, the elevation of the current position is compared with the elevation interpolated on the surface and the difference of elevation is calculated.

The surfaces stakeout can be used for:

- Stakeout of a planned surface in the field
- Quality check to test the correspondence between the built and the plan

Step	Description
------	-------------

1. Tap **STAKEOUT**.

2. Tap **Surfaces**.

3. Select a surface to stake from the ones loaded in the job.

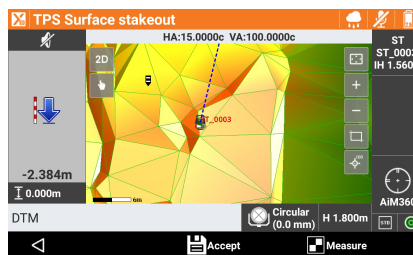

4. The side panel visualises in real-time the difference of elevation between the current position and the elevation interpolated on the surface.

5. In the input field, manage the point name.

Step	Description
------	-------------

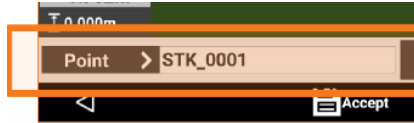

### Stake out BIM surfaces step-by-step

Step	Description
1.	Select the IFC/BIM model to be checked.
2.	Proceed with the measurement.
3.	The distance between the measured point and the plane of the selected surface is displayed.

### Stakeout report step-by-step

All stakeout data related to stakeout of points or elements are recorded in the job.

This command allows reading and exporting the data. Available output formats:

- ASCII
- CSV for Excel
- XML for Excel
- PDF
- HTML

Step	Description
1.	Tap <b>STAKEOUT</b> .
2.	Tap <b>Report</b> .
3.	A table presents the list of all stakeout points with differences, in distances and elevations, between the design coordinate and the stakeout coordinate.
4.	Tap  <b>Share</b> to create an ASCII, CSV, XML or PDF document, with all stakeout data of every point.

## 20

## TPS - Auto Measuring

### Description

Auto measuring allows checking in real-time, based on defined parameters, movements of slopes, dams, constructions, bridges and other structures.

Measured are reference points from a known station to check their position. A scale factor is applied to correct the distances measured after the environmental temperature and pressure have been added. The measurement of the reference point is automatic and follows a defined sequence.

At the end of a measuring session, a report is generated. For every measured point, the deviations measured in every session are listed.

When problems are found during the measuring sessions, e-mail or SMS notification can be sent.

## 20.1

### Settings

### Description

The auto measuring procedure has several parameters and options that are fully customisable.

#### Access

Step	Description
1.	Tap <b>Auto Measuring</b> .
2.	Tap <b>Settings</b> .

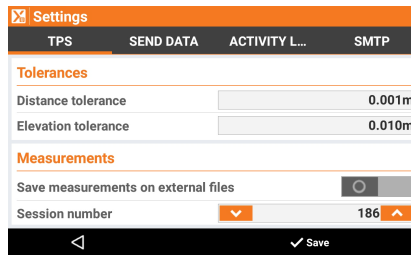

Parameters and options are organised in pages.

#### TPS page

Field	Description
<b>Tolerances</b>	
<b>Distance tolerance</b>	Maximum horizontal distance between current position and the position of the point to measure. If the distance between the current position and the position measured is more than the tolerance, the software notifies.
<b>Elevation tolerance</b>	Maximum acceptable difference between the current elevation and the elevation of the point to measure. If the difference of elevation is more than the tolerance, the software notifies.
<b>Measurements</b>	
<b>Save measurements on external files</b>	Save data to a file other than the job file to avoid that too much data is saved to the current job.
<b>Session number</b>	Sets the session ID number.
<b>Face1 &amp; Face2</b>	Measure the position of a point in both faces and calculates the average.
<b>ATR searching mode</b>	Sets the auto-collimation state of the prism.
<b>Measurements per point</b>	Number of measurements to perform per point.

Field	Description
<b>Measure rate</b>	Defines the interval of time between the measuring sessions. <ul style="list-style-type: none"> <li>• <b>Never</b> Automatic measuring procedure is never executed</li> <li>• <b>Every 15 minutes</b></li> <li>• <b>Every 30 minutes</b></li> <li>• <b>Hourly</b></li> <li>• <b>Every 2 hours</b></li> <li>• <b>Every 4 hours</b></li> <li>• <b>Every 8 hours</b></li> <li>• <b>1 time a day</b></li> <li>• <b>2 times a day</b></li> </ul>
<b>Reference time</b>	Reference time of starting of measuring session. Example: Reference time: 8:00 Frequency of sending data: <b>Hourly</b> The sessions starts at 8:00 o'clock, then hourly at 9:00, 10:00, etc.

#### Send data page

Field	Description
<b>Report data format</b>	
<b>Format</b>	Set the format for exporting the session results. The software generates and sends the files of the report to destinations (e-mail, FTP) automatically.
<b>Sessions to export</b>	Select between exporting all sessions or only the last session.
<b>Notification e-mail</b>	
<b>Notification e-mail</b>	Send the measurement notifications to an e-mail address.
<b>e-mail</b>	E-mail address for sending the measurement notifications.
<b>Attach data</b>	Attach a post-processing file downloaded during the measuring session to the notification e-mail.
<b>Server FTP1/Server FTP2</b>	
<b>Use the FTP server</b>	Send the post-processing files to an FTP area.
<b>Host</b>	Address of the FTP server.
<b>UserID</b>	User to login to the FTP server.
<b>Password</b>	Password to login to the FTP server.
<b>Check connection</b>	Tap to check if the parameters of the FTP server are correct.
<b>SMS notification</b>	
<b>Use SMS notification</b>	Send notifications by SMS to the indicated telephone numbers.
<b>Number</b>	The telephone number to which notifications of eventual problems found during the sessions are sent. More than one number can be entered separated by ";". Example: 3331234567;3318901234
<b>Sound notification</b>	
<b>Use sound notification</b>	Activates a notification by sound emitted by the controller when a measurement is out of the tolerance.
<b>Sounds</b>	Select the sound to use. Tap  to play an example of the sound.

## Activity log page

Field	Description
<b>Send data rate</b>	Frequency of sending of the measuring activity log to a certain e-mail box. <ul style="list-style-type: none"> <li>• <b>Never</b> Activity log is never sent</li> <li>• <b>After each session</b> At the end of every session, the activity log is sent to the e-mail</li> <li>• <b>1 time a day</b> The activity log is sent only once per day at 12:00 o'clock.</li> </ul>
<b>e-mail</b>	E-mail address for sending the activity logs.

## SMTP page

Field	Description
<b>Name</b>	Name of the SMTP server for sending the e-mail. Example account Google SMTP server: smtp.gmail.com
<b>UserID</b>	User to login to the SMTP server.
<b>Password</b>	Password to login to the SMTP server.

## 20.2

## Procedure

### Auto measuring - step-by-step

To perform a correct auto measuring procedure (manual or automatic), follow the steps listed in the table. Refer to the sections in this chapter for a detailed description.

Step	Description
1.	Define the control points.
2.	Set the station orientation based on the defined control points.
3.	Measure the points.
4.	Start the auto measuring procedure.

### Control points step-by-step

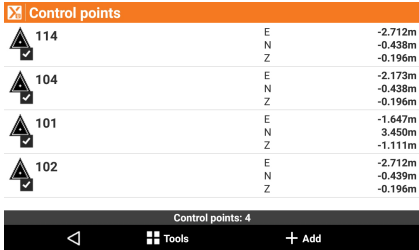

Control points are required to recalculate the position of the station in every auto measuring session.

Step	Description
1.	Tap <b>Auto Measuring</b> .
2.	Tap <b>Control points</b> .
3.	

4. Select a point from the list. The icon aside the point indicates if the point is activated or deactivated. Tap the icon to change the status.



Control point deactivated.

Step	Description
	Control point activated. 
<b>Inserting a check point</b>	
5.	Tap  <b>Add</b> to insert a point manually or by direct measurement.
<b>Editing a check point</b>	
6.	Tap <b>Edit</b> .
7.	In addition to the properties of the points, the following settings can be changed on the <b>Auto Measuring</b> tab. <ul style="list-style-type: none"> <li>• <b>Define target</b> Enables the choice of target type for the selected check point.</li> <li>• <b>Define tolerance</b> Enables the customisation of distance and elevation tolerances for the selected check point.</li> </ul>

### Points to measure step-by-step

Points to measure are the points that are measured and checked during the session.

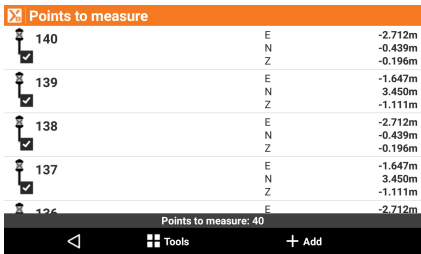
Step	Description
1.	Tap <b>Auto Measuring</b> .
2.	Tap <b>Points to measure</b> .
3.	

4. Activate or deactivate points for the auto measuring procedure. The icon aside the point indicates if the point is activated or deactivated. Tap the icon to change the status.

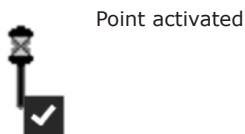
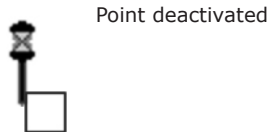

<b>Inserting a point</b>	
5.	After setting the station orientation, points can be added by direct measurement. Tap  <b>Add</b> .
<b>Editing a point</b>	
6.	Tap <b>Edit</b> .

Step	Description
7.	In addition to the properties of the points, the following settings can be changed on the <b>Auto Measuring</b> tab. <ul style="list-style-type: none"> <li>• <b>Define target</b> Enables the choice of target type for the selected check point. Customised prisms can be used.</li> <li>• <b>Define tolerance</b> Enables the customisation of distance and elevation tolerances for the selected check point.</li> </ul>

### Station orientation step-by-step

This procedure allows to set manually the orientation of the station.

Step	Description
1.	Tap <b>Auto Measuring</b> .
2.	Tap <b>Station setup</b> .

#### Orientation mode

3. The orientation mode is predefined to **Free station**. The position and orientation of the station is determined by measuring of at least two reference points with known coordinates.

#### Station data

4. Define the station.

- **Station**  
Name of the station. A new name must be defined.
- **Instrument height**  
Elevation of the total station from the ground. It is possible to calculate the height of the instrument in different ways, refer to [Description](#). To access the options tap >.
- **Code**  
Code to assign to the station point in case a new point is created.

#### Measuring reference points

5. Specify the first reference point. Type in the name or select it from the list of points or from list of check points.

6. Aim the reference point.

7. Tap **Measure**.

8. Perform the same operation for the second reference point.

9. The points measured are listed in a table. Displayed is:

- The calculated standard deviation of every point
- The total standard deviation for the calculated station position.

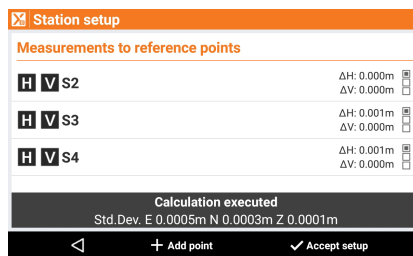

10. Tap **+ Add**.  
Adds the measurement of other reference points to improve the quality of the calculation and for more control of the data.

11. Tap **Accept setup** to confirm set data and complete the procedure.



During auto measuring, the orientation of the station is automatically calculated based on the check points.



### Automatic measurement step-by-step

Step	Description
1.	Tap <b>Auto Measuring</b> .

Step	Description
2.	Tap <b>Automatic Measuring</b> .
3.	Tap <b>Start measuring</b> to start the automatic measurement procedure based on defined parameters.
4.	At the defined time intervals, the connection to the station is activated and the reference points are measured.
5.	The position of the station is checked. A scale factor is applied to correct the distances measured after the environmental temperature and pressure have been added.
6.	The defined points are measured automatically.
7.	At the end of a measuring session, a report is generated that can be sent by e-mail or saved on an FTP area.
8.	When problems are found during the measuring sessions, e-mail or SMS notification can be sent. Problems are for example points not measured or exceeded tolerance.
9.	Tap <b>Stop measuring</b> to stop the automatic measurement procedure.

### Single, manual measurement step-by-step

The measurement of points can be started manually by the operator who occasionally goes on site and positions the station. The operations performed by the software are the same as for the automatic mode.

Step	Description
1.	Tap <b>Auto Measuring</b> .
2.	Tap <b>Single Measuring</b> .
3.	Tap  to start the session.
4.	Tap  to stop the session.
If a point cannot be measured completely or with the right accuracy, it can be measured again without having to repeat the measurements for all points.	
5.	Select the point in the list <b>Results - Δfrom Average</b> . Tap <b>Repeat measurement</b> .
If a point does not provide the right accuracy, it can be excluded from the calculation.	
6.	Select the point in the list <b>Results - Δfrom Average</b> . Tap on <b>Details</b> . Select the set to be used.
	During manual sessions, notifications about problems are not sent.

## 20.3

### Reports

#### Reports step-by-step





See the results of the sessions.

Step	Description
1.	Tap <b>Auto Measuring</b> .
2.	Tap <b>Report</b> .

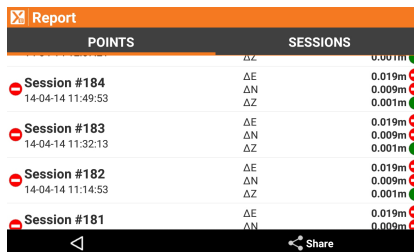

#### Points tab

- Displayed is:
  - The calculated standard deviation of every point



POINTS		SESSIONS	
	ΔZ		0.001m
Session #184 14-04-14 11:49:53	ΔE ΔN ΔZ	0.019m 0.009m 0.001m	
Session #183 14-04-14 11:32:13	ΔE ΔN ΔZ	0.019m 0.009m 0.001m	
Session #182 14-04-14 11:14:53	ΔE ΔN ΔZ	0.019m 0.009m 0.001m	
Session #181	ΔE ΔN	0.019m 0.009m	



Step	Description
	 The deviation is within the defined tolerance.
	 The deviation is outside the defined tolerance.

### Sessions tab

4. Displayed is:
- For every session, the measured points with deviations

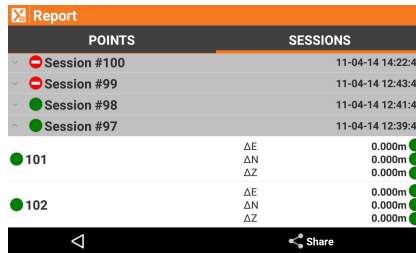

Report		
POINTS	SESSIONS	
Session #100	11-04-14 14:22:46	
Session #99	11-04-14 12:43:40	
Session #98	11-04-14 12:41:40	
Session #97	11-04-14 12:39:40	
101	$\Delta E$	0.000m
	$\Delta N$	0.000m
	$\Delta Z$	0.000m
102	$\Delta E$	0.000m
	$\Delta N$	0.000m
	$\Delta Z$	0.000m



The deviation is within the defined tolerance.



The deviation is outside the defined tolerance.

### Exporting and sharing reports

5. Tap  **Share** to export and share by e-mail, Bluetooth or similar an ASCII, CSV, XML, PDF or HTML document.

### Activity log step-by-step

Step	Description
1.	Tap <b>Auto Measuring</b> .
2.	Tap <b>Activity log</b> .
3.	Displayed are all operations performed during the sessions in a chronological way.





Activity log	
	Measuring in face F1 successfully #1 - 101
	15/04/2016 11:03:51 Complete rotation to 101
	15/04/2016 11:03:48 Measuring (Points to measure)
	15/04/2016 11:03:48 Scale factor:1.000000
	15/04/2016 11:03:48 Standard deviation E:0.0001 Standard deviation N:0.0003 Standard deviation Z:0.0001
	15/04/2016 11:03:48 Calculation of station position and orientation



Information  
The operations are done and executed without problems.



Attention  
Problems have been identified, or example the calculation of the new position of the station.

Step	Description
	 Error Errors came up during the measurements, for example impossible connecting with the instrument.
4.	Tap  <b>Activity log</b> to update the activity log.
5.	Tap  <b>Activity log</b> to update the activity log.

**Description**

COGO commands allow:

- Creating points according to different methods
- Get information related to positions of the points such as distances or angles.
- Get information related to the current position of the receiver.

**Quick distance step-by-step**



Calculate the distance only between two points quickly. Also available from survey and stakeout.





Step	Description
1.	Tap <b>COGO</b> .
2.	Tap <b>Quick distance</b> .
3.	Select: <ul style="list-style-type: none"> <li>• <b>Point 1</b> Starting point of the distance</li> <li>• <b>Point 2</b> End point of the distance</li> </ul>
4.	Tap <b>Progressive</b> to change the first or second point and to display the new calculations.
5.	The results are displayed on the right side of the panel.
6.	Tap <b>Compact</b> to reduce the information visualised.
7.	Tap <b>Clear</b> to delete all previous calculations.
8.	Tap <b>Report</b> to save the calculations in ASCII, CSV, XML, PDF or HTML format.
9.	The results are displayed on the right side of the panel.

**Distances step-by-step**

Calculates the distance and other information between a reference element and a base point or between a reference element and current position. The reference element can be another point, a line, an arc or a drawing element.

Step	Description
1.	Tap <b>COGO</b> .
2.	Tap <b>Distances</b> .
3.	<ul style="list-style-type: none"> <li>• <b>Reference object</b> Specify the reference element to which the calculation of the distance and of the other information refer to. The reference element can be:               <ul style="list-style-type: none"> <li>• <b>Point</b> Distance between a base point and a reference point or between the current position and the reference point.</li> <li>• <b>Line (2 points)</b> Distance between a base point or the current position and a line defined by two points</li> <li>• <b>Arc (3 points)</b> Distance between a base point or the current position and an arc defined by three points</li> <li>• <b>Arc (2 points+R)</b> Distance between a base point or the current position and an arc defined by two points with known radius</li> <li>• <b>Drawing object</b> Distance between a base point or the current position and a drawing element selected in the graphic window</li> </ul> </li> <li>• <b>Antenna height</b> Receiver antenna elevation. The field is shown if the option <b>Current position</b> is enabled.</li> </ul>
<b>Distance referring to a point</b>	
4.	Calculation parameters <ul style="list-style-type: none"> <li>• <b>Point 1</b> Reference point. Calculated is the distance between the base point and the reference point or between current position and the reference point.</li> <li>• <b>Info...</b> Shows the coordinates of the point.</li> </ul>
5.	Tap <b>Measure</b> .















Step	Description
6.	Reference point <ul style="list-style-type: none"> <li>• <b>Current position</b> Enables the use of the instrument position to calculate the distance in real time. If the option is not active, the software uses the reference point setting.</li> <li>• <b>Ref.point</b> Sets the reference point from which to calculate the distance.</li> </ul>
7.	Tap <b>Next</b> to execute the calculation.
<b>Distance referring to a line by two points</b>	
8.	Calculation parameters <ul style="list-style-type: none"> <li>• <b>Point 1</b> First point of the reference line.</li> <li>• <b>Point 2</b> Second point of the reference line.</li> <li>• <b>Invert</b> Inverts the direction of the line.</li> <li>• <b>Info...</b> Shows information about the object.</li> </ul>
9.	Tap <b>Tools</b> .
10.	Select the first and second point of the line. Select one of the following options: <ul style="list-style-type: none"> <li>• <b>Current position</b> Enables the use of the instrument position to calculate the distance in real time. If the option is not active, the software uses the <b>Reference point</b> setting.</li> <li>• <b>Ref.point</b> Sets the reference point from which to calculate the distance.</li> </ul>
11.	Tap <b>Next</b> to execute the calculation.
12.	 Activates the creation of a point on the projection of the base point, or of the current position, on the reference line.   Activates the stakeout procedure of the calculated position on the projection of the base point, or of the current position, on the reference line.
<b>Distance referring to an arc by three points</b>	
13.	Calculation parameters <ul style="list-style-type: none"> <li>• <b>Point 1</b> First point of the reference arc</li> <li>• <b>Point 2</b> Second point of the reference arc</li> <li>• <b>Point 3</b> Third point of the reference arc</li> <li>• <b>Invert</b> Inverts the direction of the arc.</li> <li>• <b>Info...</b> Shows information about the object.</li> </ul>
14.	Tap <b>Tools</b> .
15.	Select the first and second point of the arc. Select one of the following options: <ul style="list-style-type: none"> <li>• <b>Current position</b> Enables the use of the instrument position to calculate the distance in real time. If the option is not active, the software uses the <b>Reference point</b> setting.</li> <li>• <b>Ref.point</b> Sets the reference point from which to calculate the distance.</li> </ul>
16.	Tap <b>Next</b> to execute the calculation.
17.	 Activates the creation of a point on the projection of the base point, or of the current position, on the reference arc.



Step	Description
	 <p>Activates the stakeout procedure of the calculated position on the projection of the base point, or of the current position, on the reference arc.</p>
<b>Distance referring to an arc by two points and radius</b>	
18.	<p>Calculation parameters</p> <ul style="list-style-type: none"> <li>• <b>Point 1</b> Start point of the reference arc</li> <li>• <b>Point 2</b> End point of the reference arc</li> <li>• <b>Radius</b> Radius of the reference arc</li> <li>• <b>Arc clockwise</b> Direction of the reference arc</li> <li>• <b>Invert</b> Inverts the direction of the arc.</li> <li>• <b>Info...</b> Shows information about the object.</li> </ul>
19.	Tap <b>Tools</b> .
20.	<p>Select the first and second point and the radius of the arc. Select one of the following options:</p> <ul style="list-style-type: none"> <li>• <b>Current position</b> Enables the use of the instrument position to calculate the distance in real time. If the option is not active, the software uses the <b>Reference point</b> setting.</li> <li>• <b>Ref.point</b> Sets the reference point from which to calculate the distance.</li> </ul>
21.	Tap <b>Next</b> to execute the calculation.
22.	 <p>Activates the creation of a point on the projection of the base point, or of the current position, on the reference arc.</p>
	 <p>Activates the stakeout procedure of the calculated position on the projection of the base point, or of the current position, on the reference arc.</p>
<b>Distance referring to a CAD element</b>	
23.	<p>Select the reference drawing element from the graphic window. The distance between the reference drawing element and a base point, the current position or a reference point is calculated.</p>
24.	<p>If the selected element is a polyline: Decide whether to use the selected segment or the entire object.</p>
25.	Tap <b>Next</b> to execute the calculation.
26.	<p>Displayed is:</p> <ul style="list-style-type: none"> <li>• The distance</li> <li>• Other values calculated in real time basing on the position of the receiver.</li> </ul>
27.	 <p>Activates the creation of a point on the projection of the base point, or of the current position, on the reference element.</p>
	 <p>Activates the stakeout procedure of the calculated position on the projection of the base point, or of the current position, on the reference element.</p>

### Reference line step-by-step

Calculates the distance and other information between the current position and a reference element. The reference element can be a line, an arc or a drawing element.

Step	Description
1.	Tap <b>COGO</b> .
2.	Tap <b>Reference line</b> .
3.	<ul style="list-style-type: none"> <li>• <b>Reference object</b> Specify the reference element to which the calculation of the distance and of the other information refer to. The reference element can be: <ul style="list-style-type: none"> <li>• <b>Line (2 points)</b> Line defined by two topographics points</li> <li>• <b>Arc (3 points)</b> Arc defined by three topographics points</li> <li>• <b>Arc (2 points+R)</b> Arc defined by two topographics points and a radius</li> <li>• <b>Drawing object</b> Drawing element (line, polyline, arc, circle) selected in the graphic window</li> </ul> </li> </ul>
<b>Line by two points</b>	
4.	<p>Calculation parameters</p> <ul style="list-style-type: none"> <li>• <b>Point 1</b> First point of the reference line.</li> <li>• <b>Point 2</b> Second point of the reference line.</li> <li>• <b>Invert</b> Inverts the direction of the line.</li> <li>• <b>Info...</b> Shows information about the object.</li> </ul>
<b>Arc by three points</b>	
5.	<p>Calculation parameters</p> <ul style="list-style-type: none"> <li>• <b>Point 1</b> First point of the reference arc.</li> <li>• <b>Point 2</b> Second point of the reference arc.</li> <li>• <b>Point 3</b> Third point of the reference arc.</li> <li>• <b>Invert</b> Inverts the direction of the line.</li> <li>• <b>Info...</b> Shows information about the object.</li> </ul>
<b>Arc by two points and radius</b>	
6.	<p>Calculation parameters</p> <ul style="list-style-type: none"> <li>• <b>Point 1</b> Start point of the reference arc</li> <li>• <b>Point 2</b> End point of the reference arc</li> <li>• <b>Radius</b> Radius of the reference arc</li> <li>• <b>Arc clockwise</b> Direction of the reference arc</li> <li>• <b>Invert</b> Inverts the direction of the arc.</li> <li>• <b>Info...</b> Shows information about the object.</li> </ul>
<b>CAD element</b>	
7.	Select the drawing element to stakeout from the graphic window.
8.	Enter an offset value. Click the direction buttons to apply the offset right or left.
<b>Offset</b>	
9.	<p>After defining the reference element, an offset to the right or to the left can be applied.</p> <ul style="list-style-type: none"> <li>• <b>Offset</b> Distance to observe referring to reference element</li> <li>• <b>Height diff.</b> Vertical offset. Start from a reference object and apply a 3D offset.</li> <li>• <b>Multiplier</b> Activates the stakeout of multiple offsets according to the set value of reference offset. When the option is active, the software shows the distance from the nearest offset and displays the multiplication factor of the offset distance.</li> </ul>
<b>Stakeout information for the reference line</b>	

Step	Description
10.	 <p>Distance from the beginning of the reference element. Press <b>↑</b> to visualise the distance from the end of the element.</p>
	 <p>Distance from the end of the reference element. Press <b>↓</b> to visualise the distance from the beginning of the element.</p>
	 <p>Current position is on the left referring to the reference element.</p>
	 <p>Current position is on the left referring to the reference element.</p>
	 <p>Current position is on the right referring to the reference element.</p>
	 <p>Current position is on the right referring to the reference element.</p>
	 <p>Current position is on the reference element.</p>
	 <p>Current position is on the reference element.</p>
	 <p>The elevation is on the reference elevation.</p>
	 <p>The current elevation is below the reference elevation.</p>
	 <p>The current elevation is above the reference elevation.</p>
	 <p>The reference elevation is calculated on the reference element.</p>
	 <p>The reference elevation is the elevation at the beginning of the reference element.</p>
	 <p>The reference elevation is the elevation at the end of the reference element.</p>

Step	Description
	Enables the view of analytical mode only, which indicates the distance from the point.
	Enables the graphic window display.
	To to project the position on the reference element. Available with the TPS and the reflectorless measurement mode. The TPS rotates to the projected position and points to it with the laser pointer.

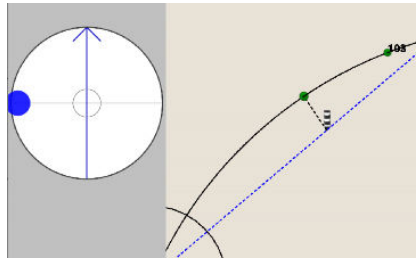



### Distance and offset step-by-step

Calculates coordinates of a point along a reference element and at a certain distance from the reference element.

Step	Description
1.	Tap <b>COGO</b> .
2.	Tap <b>Distance &amp; offset</b> .
3.	<ul style="list-style-type: none"> <li>• <b>Reference object</b> Specify the reference element. The reference element can be: <ul style="list-style-type: none"> <li>• <b>Line (2 points)</b> Line defined by two points</li> <li>• <b>Arc (3 points)</b> Arc defined by three points</li> <li>• <b>Arc (2 points+R)</b> Arc defined by two points and a radius</li> <li>• <b>Drawing object</b> Drawing element selected in the graphic window</li> </ul> </li> </ul>
<b>Line by two points</b>	
4.	Calculation parameters <ul style="list-style-type: none"> <li>• <b>Point 1</b> First point of the reference line.</li> <li>• <b>Point 2</b> Second point of the reference line.</li> <li>• <b>Invert</b> Inverts the direction of the line.</li> <li>• <b>Info...</b> Shows information about the object.</li> </ul>
<b>Arc by three points</b>	
5.	Calculation parameters <ul style="list-style-type: none"> <li>• <b>Point 1</b> First point of the reference arc.</li> <li>• <b>Point 2</b> Second point of the reference arc.</li> <li>• <b>Point 3</b> Third point of the reference arc.</li> <li>• <b>Invert</b> Inverts the direction of the line.</li> <li>• <b>Info...</b> Shows information about the object.</li> </ul>
<b>Arc by two points and radius</b>	





Step	Description
6.	Calculation parameters <ul style="list-style-type: none"> <li>• <b>Point 1</b> Start point of the reference arc</li> <li>• <b>Point 2</b> End point of the reference arc</li> <li>• <b>Radius</b> Radius of the reference arc</li> <li>• <b>Arc clockwise</b> Direction of the reference arc</li> <li>• <b>Invert</b> Inverts the direction of the arc.</li> <li>• <b>Info...</b> Shows information about the object.</li> </ul>
<b>CAD element</b>	
7.	Select the drawing element from the graphic window.
8.	Tap <b>Next</b> to proceed with the guided procedure.
9.	Parameters: <ul style="list-style-type: none"> <li>• <b>Distance along ref.ce</b> Distance at which the point is located along the reference element</li> <li>• <b>Offset on right</b> Lateral distance at which the point is located referring to the reference element</li> <li>• <b>Offset direction</b> Position of the point to the right or left of the reference element</li> <li>• <b>Height difference</b> Elevation difference to apply to the interpolated elevation of the point</li> <li>• <b>Ellipsoidal distance</b> Distance referring to the selected ellipsoid</li> <li>• <b>Ellipsoidal azimuth</b> Azimuth referring to the selected ellipsoid</li> </ul>
10.	The coordinates of the point and a graphic preview of the position are displayed.
11.	Tap <b>Next</b> to proceed with calculation of the point.
12.	 Activates the creation of the calculated point.
	 Activates the stakeout procedure for the calculated point.



### Intersection step-by-step

Calculates coordinates of a point on the intersection between straight lines.

Step	Description
1.	Tap <b>COGO</b> .
2.	Tap <b>Intersection</b> .
3.	<ul style="list-style-type: none"> <li>• <b>Method</b> Select the method to use. The method can be:               <ul style="list-style-type: none"> <li>• <b>Double distance</b> The intersection position is calculated based on two distances referring to two reference points</li> <li>• <b>Distance and Azimuth</b> The intersection position is calculated based on the distance of a reference point along a straight line and a second reference point</li> <li>• <b>Double Azimuth</b> The intersection position is calculated on the intersection of two straight lines and two reference points</li> <li>• <b>4 points</b> The intersection position is calculated on the intersection of two straight lines and four reference points</li> </ul> </li> </ul>
<b>Double distance</b>	



Step	Description
4.	First point: <ul style="list-style-type: none"> <li>• <b>Point 1</b> First reference point</li> <li>• <b>Distance 1</b> Distance from the first reference point</li> </ul>
5.	Tap <b>Next</b> to proceed with the guided procedure.
6.	Second point: <ul style="list-style-type: none"> <li>• <b>Point 2</b> Second reference point</li> <li>• <b>Distance 2</b> Distance from the second reference point</li> </ul>
7.	Tap <b>Next</b> to proceed with calculation of the point.
8.	The two possible solutions are displayed. Select the desired solution in the graphic window.
9.	 Activates the creation of the calculated point.   Activates the stakeout procedure for the calculated point.

#### Distance and azimuth



10.	First point: <ul style="list-style-type: none"> <li>• <b>Point 1</b> First reference point</li> <li>• <b>Distance 1</b> Distance from the first reference point</li> </ul>
11.	Tap <b>Next</b> to proceed with the guided procedure.
12.	Second point: <ul style="list-style-type: none"> <li>• <b>Point 2</b> Second reference point</li> <li>• <b>Azimuth 2</b> Azimuth of the straight line going through the point</li> <li>• <b>Offset</b> Distance to the straight line going through the point</li> <li>• <b>Offset direction</b> Position of the point to the right or left of the straight line going through the point</li> </ul>
13.	Tap <b>Next</b> to proceed with calculation of the point.
14.	The two possible solutions are displayed. Select the desired solution in the graphic window.
15.	 Activates the creation of the calculated point.   Activates the stakeout procedure for the calculated point.

#### Double azimuth

16.	First point: <ul style="list-style-type: none"> <li>• <b>Point 1Next</b> First reference point</li> <li>• <b>Azimuth 1</b> Azimuth of the straight line going through the point</li> <li>• <b>Offset</b> Distance to the straight line going through the point</li> <li>• <b>Offset direction</b> Position of the point to the right or left of the straight line going through the point</li> </ul>
-----	--

Step	Description
17.	Tap <b>Next</b> to proceed with the guided procedure.
18.	Second point: <ul style="list-style-type: none"> <li>• <b>Point 2</b> Second reference point</li> <li>• <b>Azimuth 2</b> Azimuth of the straight line going through the point</li> <li>• <b>Offset</b> Distance to the straight line going through the point</li> <li>• <b>Offset direction</b> Position of the point to the right or left of the straight line going through the point</li> </ul>
19.	Tap <b>Next</b> to proceed with calculation of the point.
20.	The coordinates of the calculated point are displayed.
21.	 Activates the creation of the calculated point.   Activates the stakeout procedure for the calculated point.



#### Four points

22.	First segment: <ul style="list-style-type: none"> <li>• <b>Point 1</b> First reference point of the first straight line</li> <li>• <b>Point 2</b> Second reference point of the first straight line</li> <li>• <b>Offset</b> Distance to the straight line going through the two points</li> <li>• <b>Offset direction</b> Position of the point to the right or left of the straight line going through the two points</li> </ul>
23.	Tap <b>Next</b> to proceed with the guided procedure.
24.	Second segment: <ul style="list-style-type: none"> <li>• <b>Point 1</b> First reference point of the second straight line</li> <li>• <b>Point 2</b> Second reference point of the second straight line</li> <li>• <b>Offset</b> Distance to the straight line going through the two points</li> <li>• <b>Offset direction</b> Position of the point to the right or left of the straight line going through the two points</li> </ul>
25.	Tap <b>Next</b> to proceed with calculation of the point.
26.	The coordinates of the calculated point are displayed.
27.	 Activates the creation of the calculated point.   Activates the stakeout procedure for the calculated point.

#### Area subdivision step-by-step

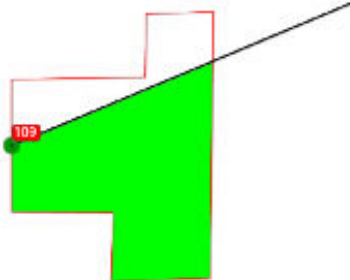

Divides an area on a surface defined by a polyline, a parcel or a sequence of points. The dividing line can be parallel or perpendicular to the reference points.

Step	Description
1.	Tap <b>COGO</b> .
2.	Tap <b>Area subdivision</b> .

Step	Description
3.	<ul style="list-style-type: none"> <li>• <b>Area to subdivide</b> <ul style="list-style-type: none"> <li>• <b>Area type</b> Select the contour defining the area to divide.</li> </ul> </li> </ul>
4.	Tap <b>Next</b> to proceed with the guided procedure.
5.	Dividing line: <ul style="list-style-type: none"> <li>• <b>Method</b> Specify the position of the dividing line referring to the reference points.               <ul style="list-style-type: none"> <li>• <b>Parallel by 2 points</b> The dividing line is parallel to the line through the reference points.</li> <li>• <b>Perpendic. by 2 points</b> The dividing line is perpendicular to the line through the reference points.</li> <li>• <b>Hinge point</b> The calculation is based on a fixed point and the size of the area to be subdivided. Using the fixed point as the center of rotation, the correct position of the dividing line delimiting the defined area, is calculated.</li> </ul> </li> </ul>
	
	<ul style="list-style-type: none"> <li>• <b>Point 1 and Point 2</b> Reference points defining the dividing line</li> <li>• <b>Area to subdivide</b> Select the area to divide in the graphic preview</li> </ul>
6.	Tap <b>Next</b> to proceed with the guided procedure.
7.	Area to divide: <ul style="list-style-type: none"> <li>• <b>Area type</b> How the value of division is entered:               <ul style="list-style-type: none"> <li>• <b>Value</b> Actual size of the area</li> <li>• <b>% Percentage</b> Size entered in percent of the whole area</li> </ul> </li> <li>• <b>Total area</b> Size of the whole area</li> <li>• <b>Area (value)</b> Actual size of the divided area</li> <li>• <b>Area (%)</b> Size of the divided area in percent</li> </ul>
8.	Tap <b>Next</b> to display the position of the crossing points.
9.	Select the crossing point to record or to use for stakeout in the graphic window.
10.	Activates the creation of the calculated point. <div style="text-align: center; margin: 10px 0;">  </div>
	Activates the stakeout procedure for the calculated point. <div style="text-align: center; margin: 10px 0;">  </div>

### Area and length step-by-step

Calculates, during the survey operation, the circumference of an area and the length between the points forming the area.







Step	Description
1.	Tap <b>COGO</b> .
2.	Tap <b>Area &amp; Length - Volume</b> .
3.	Tap <b>Measure</b> to measure the points defining the area.
4.	Tap <b>Delete last</b> to cancel the measurement of the last stored point.
5.	During the measurement, the corresponding volume and the area of the walls can be displayed: <ul style="list-style-type: none"> <li>• <b>Volume</b> The calculated volume using the points measured so far</li> <li>• <b>Area walls</b> The calculated area of the walls surrounding the volume using the points measured so far. One side is open.</li> <li>• <b>Area walls(closed)</b> The calculated area of the walls surrounding the volume using the points measured so far. The area is closed from the last point measured to the first point.</li> </ul>
6.	Areas and lengths: <ul style="list-style-type: none"> <li>• <b>Perimeter 2D</b> Displays the plane length of the circumference</li> <li>• <b>Perimeter 3D</b> Displays the three-dimensional length of the circumference</li> <li>• <b>Length 2D</b> Displays the plane length of the line between the points</li> <li>• <b>Length 3D</b> Displays the three-dimensional length of the line between the points</li> </ul>
7.	<div style="display: flex; align-items: center; margin-bottom: 10px;">  <span>Displays two-dimensional data</span> </div> <div style="display: flex; align-items: center;">  <span>Displays three-dimensional data</span> </div>

### Check planes step-by-step

Check drawing elements or measured positions on site. The checks can relate to elevations, distances, angles or surfaces.

Step	Description
1.	Tap <b>COGO</b> .
2.	Tap <b>Check planes</b> .
3.	<ul style="list-style-type: none"> <li>• <b>Method</b> Select the method to use. The method can be: <ul style="list-style-type: none"> <li>• <b>Horizontal level</b> Checks the elevation difference between the reference elevation and the elevation measured by the instrument. The software uses a horizontal level passing through the reference elevation to perform the control.</li> <li>• <b>Vertical plane</b> Available for TPS instruments. Checks the elevation difference between the reference elevation and the elevation measured by the instrument. The software uses a vertical level passing through the reference points.</li> <li>• <b>Level with 1 slope</b> Checks the elevation difference between a defined level by applying a gradient along a reference direction and the current measured elevation.</li> <li>• <b>Level with 2 slopes</b> Checks the elevation difference between a defined level and the elevation measured by instrument. A reference plane is defined by applying a first slope on a reference axis and a second slope on the axis perpendicular to it.</li> <li>• <b>Level by 3 points</b> Checks the elevation difference between a reference level and the measured current elevation. The reference level is defined by measuring three references points.</li> </ul> </li> <li>• <b>Antenna height</b> Antenna elevation of the receiver. The field is shown if the option <b>Current position</b> is enabled.</li> </ul>
<b>Control of elevation on horizontal level</b>	
4.	<ul style="list-style-type: none"> <li>• <b>Ref. elevation</b> Sets the reference elevation to use for the elevation check.</li> </ul>

Step	Description
5.	Tap <b>Measure</b> to measure the current elevation and use it as reference elevation.
6.	Displayed is in real time: <ul style="list-style-type: none"> <li>• Difference between the measured elevation and the reference elevation</li> <li>• Distance between the reference point and the current position</li> <li>• Slope between the reference point and the current position</li> </ul>
<b>Control of elevation on vertical level</b>	
	Available for TPS instruments.
7.	<b>Ref. elevation</b> Sets the reference elevation to use for the elevation check.
8.	Tap <b>Measure</b> to measure the current elevation and use it as reference elevation. OR Tap <b>Select</b> .
9.	Measure the point which sets the direction of vertical axis. Tap <b>Measure</b> .
10.	Measure the second reference point. Tap <b>Measure</b> .
11.	Tap <b>Measure</b> .
12.	Displayed is in real time: <ul style="list-style-type: none"> <li>• Difference between the measured elevation and the reference elevation</li> <li>• Distance between the reference point and the current position</li> <li>• Slope between the reference point and the current position</li> </ul>
<b>Control of elevation on level with one slope</b>	
13.	Define the origin point of the axis along which to apply the slope. Tap <b>Measure</b> . OR Tap <b>Select</b> .
14.	Define the direction of the axis along which to apply the slope. Measure the position which defines the direction. Tap <b>Measure</b> .
15.	Set the longitudinal slope on the axis.
16.	Displayed is in real time: <ul style="list-style-type: none"> <li>• Difference between the measured elevation and the reference elevation</li> <li>• Distance between the origin and the reference line</li> <li>• Slope</li> </ul>
<b>Control of elevation on level with two slopes</b>	
17.	Define the origin point of the axis along which to apply the slope. Tap <b>Measure</b> . OR Tap <b>Select</b> .
18.	Define the direction of the axis along which to apply the slope. Measure the position which defines the direction. Tap <b>Measure</b> .
19.	Set the longitudinal and transversal slope on the axis.
20.	Displayed is in real time: <ul style="list-style-type: none"> <li>• Difference between the measured elevation and the reference elevation</li> <li>• Distance between the origin and the reference line</li> <li>• Slope</li> </ul>
<b>Control of elevation on level by three points</b>	
21.	Define the first point of the plane. Tap <b>Measure</b> . OR Tap <b>Select</b> .
22.	Define the second point of the plane. Tap <b>Measure</b> . OR Tap <b>Select</b> .
23.	Define the third point of the plane. Tap <b>Measure</b> . OR Tap <b>Select</b> .

Step	Description
<b>Display of elevation controls</b>	
24.	After the reference plane has been created, icons appear at the bottom of the window.
	The current elevation is below the reference elevation.
	The current elevation is above the reference elevation.
	The elevation is on the reference elevation.
	Distance on the X-axis of the plane to the measured point.
	Distance on the Y-axis of the plane to the measured point.
	Slant distance from the point to the point of origin of the plane.
	Slope between the measured point and the origin of the plane.

### Move, rotate & scale step-by-step

Performs different rotations and transformations of points and drawing elements.

Step	Description
1.	Tap <b>COGO</b> .
2.	Tap <b>Move, Rotate &amp; Scale</b> .
3.	<ul style="list-style-type: none"> <li><b>Method</b> Select the method to use. The method can be: <ul style="list-style-type: none"> <li><b>Manual entry</b> Enter values for rotation, scaling and shifting to transform points and selected objects.</li> <li><b>Select matching points</b> Create a list of pairs of points used to calculate the parameters to transform points and selected objects.</li> </ul> </li> </ul>
<b>Manual entry</b>	
4.	Parameters and options are organised in pages. Enter the parameters to perform the transformation.
<b>Page 1</b>	
5.	<p><b>1. Move</b> The shifting values can be calculated as difference from existing topographic points or as difference from entered coordinates.</p> <ul style="list-style-type: none"> <li><b><math>\Delta E/\Delta N/\Delta Z</math></b> Shifting value of the three axes</li> </ul> <p><b>Starting point</b></p> <ul style="list-style-type: none"> <li><b>E/N/Z</b> Coordinates of the first point to move.</li> </ul> <p><b>Destination point</b></p> <ul style="list-style-type: none"> <li><b>Point</b> Name of the point where the first point must be moved to.</li> </ul>

Step	Description
6.	Tap <b>Next</b> .
<b>Page 2</b>	
7.	<p><b>2. Rotate</b> The rotation angle can be calculated as difference of azimuths. Azimuths can be calculated as direction from existing topographic points.</p> <ul style="list-style-type: none"> <li>• <b>Rotation angle</b> Value for the rotation</li> </ul> <p><b>Rotation and Scale point</b></p> <ul style="list-style-type: none"> <li>• <b>Point</b> Reference point for the rotation and scaling. This point stays fixed. Enter the point or tap &gt; to select the point.</li> <li>• <b>E/N</b> Coordinates of the reference point</li> </ul> <p><b>Starting direction</b></p> <ul style="list-style-type: none"> <li>• <b>Direction</b> Direction for the scaling</li> <li>• <b>From</b> Beginning for the scaling. Enter the point or tap &gt; to select the point.</li> <li>• <b>To</b> End for the scaling. Enter the point or tap &gt; to select the point.</li> </ul>
8.	Tap <b>Next</b> .
9.	<p><b>Select points/objects</b> page</p> <ul style="list-style-type: none"> <li>• <b>All points</b> The transformation is applied to all points of current job.</li> <li>• <b>Select points</b> The transformation is applied to the points selected from the list of topographic points.</li> <li>• <b>All points/drawings</b> The transformation is applied to all points and drawing objects of current job.</li> <li>• <b>Select points/drawings</b> Select points and drawing objects, that have to be transformed, from the CAD view.</li> <li>• <b>Only drawings</b> The transformation is applied to all drawing entities of current job.</li> <li>• <b>IFC documents</b> The transformation is applied a selected IFC file. Define the start and target position. The IFC model is moved to the right position, even if it has local coordinates. The moved, shifted and rotated elements are displayed in the CAD view.</li> </ul>
10.	Tap <b>Next</b> .
11.	<p><b>Save options</b> page</p> <ul style="list-style-type: none"> <li>• <b>Overwrite points/drawings</b> The points and the drawing objects are updated with the new calculated positions.</li> <li>• <b>Backup job and Overwrite points/drawings</b> A backup of current job is stored without transformation. The points and the drawing objects are updated with the new calculated positions in the current job.</li> <li>• <b>Save as new points</b> The points with the new calculated positions are stored as new points in the current job.</li> <li>• <b>Prefix</b> Define a prefix for the points that are stored when selecting the <b>Save as new points</b>.</li> </ul>
<b>Select matching points</b>	
12.	Parameters and options are organised in pages. Enter the parameters to perform the transformation.
13.	<ul style="list-style-type: none"> <li>• <b>Calculation mode</b> Select the method to use. The method can be: <ul style="list-style-type: none"> <li>• <b>Rigid (scale = 1)</b> Performs one rotation and one barycentric translation.</li> <li>• <b>Conformal (scaled)</b> Performs the fitting of the survey based on the set reference points. A transformation and a scale factor are applied.</li> </ul> </li> </ul>
14.	Tap  to enter a new point and the required data.



Step	Description
15.	<p><b>Add point</b> page</p> <ul style="list-style-type: none"> <li>• <b>Source</b> Select the method to use. The method can be: <ul style="list-style-type: none"> <li>• <b>Select position from CAD</b> Select the point from the CAD window.</li> <li>• <b>Select point</b> Enter the point name.</li> </ul> </li> <li>• <b>Select point</b> Select the name of the point or the position.</li> <li>• <b>Target</b> Select the method to use. The method can be: <ul style="list-style-type: none"> <li>• <b>Select position from CAD</b> Select the point from the CAD window.</li> <li>• <b>Select point</b> Enter the point name.</li> </ul> </li> <li>• <b>Select point</b> Select the name of reference point or the position.</li> <li>• <b>Use HV</b> Select the calculation parameters to use. <ul style="list-style-type: none"> <li>• <b>H + V</b> The coordinates are used for the horizontal and vertical transformation.</li> <li>• <b>Only H</b> The coordinates are used for the horizontal transformation only.</li> <li>• <b>Only V</b> The coordinates are used for the vertical transformation only.</li> <li>• <b>None</b> The values of the transformation are not be used.</li> </ul> </li> </ul>
16.	Tap <b>Add</b> to repeat the operation for the other matching points.
17.	Tap <b>Next</b> .
18.	<p><b>Select points/objects</b> page</p> <ul style="list-style-type: none"> <li>• <b>All points</b> The transformation is applied to all points of current job.</li> <li>• <b>Select points</b> The transformation is applied to the points selected from the list of topographic points.</li> <li>• <b>All points/drawings</b> The transformation is applied to all points and drawing objects of current job.</li> <li>• <b>Select points/drawings</b> Select points and drawing objects, that have to be transformed, from the CAD view.</li> <li>• <b>Only drawings</b> The transformation is applied to all drawing entities of current job.</li> <li>• <b>IFC documents</b> The transformation is applied a selected IFC file. Define the start and target position. The IFC model is moved to the right position, even if it has local coordinates. The moved, shifted and rotated elements are displayed in the CAD view.</li> </ul>
19.	Tap <b>Next</b> .
20.	<p><b>Save options</b> page</p> <ul style="list-style-type: none"> <li>• <b>Overwrite points/drawings</b> The points and the drawing objects are updated with the new calculated positions.</li> <li>• <b>Backup job and Overwrite points/drawings</b> A backup of current job is stored without transformation. The points and the drawing objects are updated with the new calculated positions in the current job.</li> <li>• <b>Save as new points</b> The points with the new calculated positions are stored as new points in the current job.</li> <li>• <b>Prefix</b> Define a prefix for the points that are stored when selecting the <b>Save as new points</b>.</li> </ul>

**Description**

**Volumes**

Calculates the movement of material according to different modes. The calculation is based on a triangular, three-dimensional surface built by points from the archive or imported from different formats.

**Surfaces**

Required element for the volumes calculation.

It is possible to create and manage different surfaces inside the same job.

Options to create a surface:

- Automatic calculation basing on the points available in the archive and on the defined breaklines.
- Manual creation to obtain a result most to the real surface by improving the calculation results.

Options to represent a surface:

- Only with lines
- With shading
- With color based on the elevation
- With contour lines

**22.1**

**Surfaces**

**Access**

Step	Description
1.	Tap <b>Volume &amp; Surface</b> .
2.	Tap <b>Surfaces</b> .
3.	Listed are all surfaces available in the archive including the minimum and maximum elevation, the 2D surface and the 3D surface.

**Creating a surface step-by-step**

**Access**

Step	Description
1.	Tap  .
2.	Parameters and options are organised in pages. Enter the data on the pages listed below this table.
3.	Tap <input checked="" type="checkbox"/> <b>Accept</b> to calculate the surface. At the end of calculation, the surface is displayed inside a specific graphic viewer.
4.	If <b>Manual triangulation</b> is selected, no calculation is done. Only the points available in the archived are displayed in the graphic viewer. Use the commands of the viewer to build and modify the surface.

**Properties page**

Field	Description
<b>Name</b>	Name to assign to the surface
<b>Style</b>	Representation of the surface <ul style="list-style-type: none"> <li>• <b>Wireframe</b> The segments of the triangles composing the surface are drawn.</li> <li>• <b>Shade</b> The faces of the triangles are colored based on the direction of light exposure.</li> </ul>

Field	Description
<b>Color</b>	<p>Colour to use for the surface</p> <ul style="list-style-type: none"> <li>• <b>Original</b> The colour of the layer containing the triangles is used.</li> <li>• <b>By elevation (terrain)</b> The faces are coloured based on the elevation of the centre of gravity. The colour scale starts from green, passes through yellow and ends with red.</li> <li>• <b>Surface</b> A color can be defined in the field <b>Surface color</b>.</li> <li>• <b>By elevation (sea)</b> The faces are coloured based on the elevation on sea level. The colour scale starts from green, passes through blue and ends with white.</li> </ul>
<b>Surface color</b>	Colour to use for the surface if the option <b>Surface</b> is chosen.



### Points & lines page



Field	Description
<b>Manual triangulation</b>	Activate this option to build the triangles composing the surface manually.
<b>Points</b>	<p>Define the set of points to use in case of automatic building. Press the button on the right of the input field to access the list of points or to a menu allowing to select points.</p> <ul style="list-style-type: none"> <li>• <b>Load all points</b> All points from the archive are used to calculate the surface.</li> <li>• <b>Select from table</b> Select points from the points table.</li> <li>• <b>Select from CAD</b> Select points from the graphic window.</li> <li>• <b>Delete points list</b> Delete the points loaded as vertexes of triangles</li> </ul>
<b>Breaklines</b>	<p>Specify the breaklines to check the shape of the surface. The breaklines must be inserted previously as polylines in the graphic window. Press the button on the right of the input field to access to a menu:</p> <ul style="list-style-type: none"> <li>• <b>Select from CAD</b> Select breaklines from the graphic window.</li> <li>• <b>Clear all</b> Delete the previously selected breaklines.</li> </ul>
<b>Boundaries</b>	<p>Specify contour lines as border of the surface. The breaklines must be inserted previously as polylines in the graphic window. Press the button on the right of the input field to access to a menu:</p> <ul style="list-style-type: none"> <li>• <b>Select from CAD</b> Select the contour lines from graphic window.</li> <li>• <b>Delete all</b> Delete the previously selected contour lines.</li> </ul>

### Editing a surface step-by-step

Step	Description
1.	Select a surface in the list of surfaces.
2.	Tap <b>View</b> .
3.	Use the commands of the graphic viewer for editing the surface.

### Buttons



Button	Description
	<p><b>Data</b> Tap  to edit parameters for the visualisation of the surface.</p>

Button	Description
	<b>New</b> Build a new triangle. Indicate the three points composing the triangle.
	<b>Swap</b> Change the direction of the faces of two triangles having a common side.
	<b>Delete</b> Select triangles to delete.



### Visualisation of surface on Google Map step-by-step





To visualise the surface on Google Map, a coordinate system must be defined allowing the transformation of the coordinates in WGS84 used by Google Map.

Step	Description
1.	Tap  .
2.	Tap  .

### Visualisation of a surface in 3D step-by-step

Step	Description
1.	Tap  .
2.	Tap  .
3.	Tap  .
4.	Tap <b>3D View</b> .
5.	Use the commands of the graphic viewer for editing the surface.

### Buttons

Button	Description
	<b>Data</b> Tap  to edit parameters for the visualisation of the surface.
	<b>Views</b> Select one of the predefined views using the faces of the cube.

### Editing visualisation parameters step-by-step

Step	Description
1.	Select the corresponding line in the list of the surfaces.
2.	Tap <b>Properties</b> .
3.	Edit the data on the pages listed below this table.

### Properties page

Field	Description
<b>Name</b>	Name to assign to the surface

Field	Description
<b>Style</b>	Representation of the surface <ul style="list-style-type: none"> <li><b>Wireframe</b> The segments of the triangles composing the surface are drawn.</li> <li><b>Shade</b> The faces of the triangles are colored based on the direction of light exposure.</li> </ul>
<b>Color</b>	Colour to use for the surface <ul style="list-style-type: none"> <li><b>Original</b> The colour of the layer containing the triangles is used.</li> <li><b>By elevation (terrain)</b> The faces are coloured based on the elevation of the centre of gravity. The colour scale starts from green, passes through yellow and ends with red.</li> <li><b>Surface</b> A color can be defined in the field <b>Surface color</b>.</li> <li><b>By elevation (sea)</b> The faces are coloured based on the elevation on sea level. The colour scale starts from green, passes through blue and ends with white.</li> </ul>
<b>Surface color</b>	Colour to use for the surface if the option <b>Surface</b> is chosen.

### Contour lines page



Field	Description
<b>Contour lines</b>	Activates the visualisation of the contour lines of the surface.
<b>Contour step</b>	Step to use to draw the contour lines.
<b>Contour color</b>	Colour to use to draw the contour lines.

### Deleting a surface step-by-step

Step	Description
1.	Select the corresponding line in the list of surfaces.
2.	Tap <b>Delete</b> .

### Staking out a surface step-by-step

The procedure of stakeout of surfaces allows to determinate, in every position, the difference of elevation between the existing ground and the surface planned.

Step	Description
1.	Select the corresponding line in the list of the surfaces.
2.	Tap <b>Stakeout</b> .
3.	<div style="display: flex; align-items: center;">  <div style="margin-left: 10px;"> <p>Displayed is:</p> <ul style="list-style-type: none"> <li>The offset difference between the current measured elevation and the target surface elevation</li> <li>The target value at the current location</li> </ul> </div> </div>
4.	Tap  .
5.	Tap <b>Autoselect surface by position</b> . Selects the next surface to stakeout according to the current position without having to know the name of the surface.

### Importing a surface step-by-step

Import defined surfaces from files in DXF or LandXML format.

Step	Description
1.	Tap  .

Step	Description
2.	Tap <b>Tools</b> .
3.	Select the format to use to import.
4.	Select the file to import.
5.	The imported surface is displayed in the table.

### Exporting a surface step-by-step

Export a DXF file that contains the selected surface. Use this option to share the surfaces with other teams and software tools in the field (like excavators).

Step	Description
1.	In the list of surfaces select a surface.
2.	Tap the surface.
3.	Tap <b>Export DXF</b> .

### Viewing the surfaces in CAD step-by-step

In the main graphic window, it is possible to manage the visualisation of the surfaces present in the archive.

Step	Description	On a Smartphone
1.	Tap <b>Project Info</b> .	Tap <b>Data</b> .
2.	Tap .	
3.	The appearing table displays a list of the present surfaces.	
4.	Visible surfaces are marked by . Invisible surfaces are marked by .	
5.	Click the symbol to change the visibility of a surface.	
6.	Tap  to modify visualization parameters or to start to stakeout procedures.	

## 22.2

### Volumes

#### Access

Perform volume calculations and display the results as calculated value and as graphic representation.

Step	Description
1.	Tap <b>Volume &amp; Surface</b> .
2.	Tap <b>Volume</b> .
3.	Listed are all calculated volumes available in the archive including the type of calculation used and the volumes of cut and fill.

#### Volume referring to a reference elevation step-by-step

Calculate the volume between a reference surface and a horizontal plane to an established elevation.

Step	Description
1.	Tap <b>New</b> .
2.	Tap <b>Ref.Elevation</b> .
3.	<b>Ref.Elevation</b> Reference elevation referring to which to execute the volume calculation.

#### Volume referring to a reference point step-by-step

Calculate the volume between a reference surface and a horizontal plane at an established elevation by a reference point.

Step	Description
1.	Tap <b>New</b> .

Step	Description
2.	Tap <b>Ref.Point</b> .
3.	<b>Ref.Point</b> Point from the archive referring to the elevation of which to execute the volume calculation.

### Volume of a stockpile or pit step-by-step

Calculate, in reference to the reference surface, a second surface considering only the points present in the perimeter of the reference surface. Calculated is the volume between the reference surface and a second surface representing the bottom, in case of stockpile, or representing the top, in case of pit.

Step	Description
1.	Tap <b>+ New</b> .
2.	Tap <b>Stockpile/Pit</b> .
3.	Set the calculation parameters
4.	Tap <b>Accept</b> .

### Volume referring to a reference level step-by-step

Calculate the volume between a reference surface and a plane passing by three points.

Step	Description
1.	Tap <b>+ New</b> .
2.	Tap <b>Reference plane</b> .
3.	Volume calculation <ul style="list-style-type: none"> <li>• <b>Point 1</b> First reference point of the project plane</li> <li>• <b>Point 2</b> Second reference point of the project plane</li> <li>• <b>Point 3</b> Third reference point of the project plane</li> </ul>
4.	Tap <b>Next</b> to proceed in the guided procedure.

### Volume by thickness step-by-step

Calculate the volume between a reference surface and a plane considering the thickness of the surface.

Step	Description
1.	Tap <b>+ New</b> .
2.	Tap <b>By thickness</b> .
3.	Enter the thickness value.
4.	Tap <b>Next</b> to proceed in the guided procedure.

### Volume by surface difference step-by-step

Calculate the volume between two surfaces. The two surfaces can have different shapes. The volume is calculated in the overlapping area. The two surfaces can belong to two different jobs.

Step	Description
1.	Tap <b>+ New</b> .
2.	Tap <b>Surfaces difference</b> .
3.	Volume calculation <ul style="list-style-type: none"> <li>• <b>Surface 1</b> The first surface for the calculation.</li> <li>• <b>Surface 2</b> <ul style="list-style-type: none"> <li>• <b>Source</b> Select if the second surface is stored in the same or in another job.</li> <li>• <b>Reference job</b> In case of another job, select the name of the job.</li> </ul> </li> <li>• <b>Surface 2</b> The second surface for the calculation.</li> </ul>

Step	Description
4.	Tap <b>Next</b> to proceed in the guided procedure.

### Volume calculation step-by-step

Step	Description
1.	<p>After having selected the type of calculation and set the corresponding parameters.</p> <ul style="list-style-type: none"> <li>• <b>Name</b> Name to assign to elaboration</li> <li>• <b>Cut swell factor</b> Expansion factor for the cut volumes. The expansion factor can be inserted manually or chosen from a list of preset materials.</li> <li>• <b>Calculate weight</b> Activates the calculation of the weight of the material excavated and filled considering the specific weight.</li> <li>• <b>Weight (t/m<sup>3</sup>)</b> Specific weight in tons per cubic meter. The specific weight can be inserted manually or chosen from a list of preset materials.</li> <li>• <b>Auto adjust cut/fill</b> In the case of volume calculation with reference plane, it is possible to activate the adjustment of cut and fill. Keeping the defined slopes of the plane, the plane is moved vertically to balance cut and fill volumes.</li> <li>• <b>Calculation type/direction</b> The volume calculation of a surface can be interpreted as excavation (cut) or as a filling of material. Example: To calculate the material that must be removed that has already been removed (cut), calculate the volume of a surface below the reference elevation. To calculate the filling material to cover the excavation (fill), the amount is the same but the meaning is different. Select a case so that the volume is displayed as cut or fill. <ul style="list-style-type: none"> <li>• <b>Excavation to fill</b></li> <li>• <b>Excavation to be executed</b></li> <li>• <b>Fill material to remove</b></li> <li>• <b>Fill material to build</b></li> <li>• <b>Surface to elevation</b></li> <li>• <b>Elevation to surface</b></li> </ul> </li> </ul>
2.	Tap <input checked="" type="checkbox"/> <b>Accept</b> .
3.	Displayed is the list of surfaces available in the archive. Select the surface reference referring to which performing the volume calculation.
4.	At the end of the calculation, all results are reported concerning volumes as well as cut and fill surfaces.
5.	<p>Tap <b>View</b> to access to graphic visualisation of calculated volumes. The colour of triangles depends on the elevation difference in cut and fill:</p> <ul style="list-style-type: none"> <li>• Red Maximum excavation zones</li> <li>• Yellow Zones with no excavation or filling</li> <li>• Green Zones of maximum filling</li> </ul>

### Viewing calculated data step-by-step

Step	Description
1.	Tap <b>Details</b> to access information of an elaboration.
2.	<p>Calculated data</p> <ul style="list-style-type: none"> <li>• <b>Details</b> List of data of the elaboration. Tap <b>Report</b> to obtain a report in different formats of calculated data.</li> <li>• <b>View</b> Graphic visualisation of the elaboration. <ul style="list-style-type: none"> <li>• Red areas Refer to a pit zone</li> <li>• Areas in green Refer to a zone of stockpile</li> <li>• For GPS: Cross-section view in 3D at the current position See screenshot below.</li> </ul> </li> </ul> <p>A button in the toolbar activates the query mode: by clicking on graphic area it displays the cut and fill differences.</p>



Step	Description
------	-------------

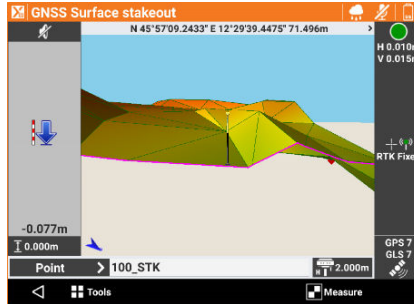

At the current position, the surface is cut by a vertical plane perpendicular to the current direction. The cross-section view shows the exact shape of the surface.

### Deleting a calculated volume step-by-step

Step	Description
------	-------------

1. Select the corresponding line in the list of volumes.
2. Tap **Delete**.

**Description****Functionality**

- Managing road design data in the field
- Performing all stakeout operations without using point coordinates but using original design data  
Stakeout and obtaining road design information is possible at any station.

**Import**

- From LandXML format
- From local road design software data format
- From CAD polyline available in the current job

**Managing design data**

- Import road model from external files  
Design road models by defining the main elements as horizontal and vertical alignment, cross-section templates, superelevation and widening rules
- Directly on the controller
- More than one axis can be managed at the same time
- All design data are displayed in plan view, longitudinal profile view and cross-section view.

**Modes**

Field	Description
<b>Cross sections</b>	The interpolated cross-section is calculated at any station.
<b>Road edges</b>	Cross-sections are calculated, at any stations, from the intersection with road edge polylines.
<b>Cross-sections templates</b>	One or more cross-section template can be applied along the center line. A cross-section template can be fully customised defining the cross-section shape including information such as superelevations and widenings.

**Stakeout**

Stakeout the road design data and side slopes at any station and with any offset.

The point to stakeout can be specified on the cross-section view. The current position is displayed in three different views: plan, longitudinal profile, cross-sections.

**Where am I?**

The command allows to have all design information about the current position along the road:

- Station
- Offset
- Horizontal alignment element
- Vertical alignment element
- Elevation difference from design elevation
- Elevation difference from current surface

**Using Roading together with Volume & Surface**

It is possible to stakeout road design data and use a three-dimensional design model (surface) as reference for the elevations.





**23.1****Road Manager****Access**

**Road manager** is the control panel of all data of the road project.

Step	Description
1.	Tap <b>ROADS</b> .
2.	Tap <b>Road manager</b> .
3.	Listed are all axes and all side polylines that have been loaded.

### Importing road data step-by-step

The project data can be imported from different formats.

Step	Description
<b>Importing road project from LandXML format</b>	
1.	Tap  .
2.	Tap <b>Import road data</b> .
3.	Tap <b>LandXML Format</b> .
4.	Select the LandXML file to import.
5.	All axes and side polylines are loaded and displayed in the list.
<b>Importing road axis from DXF file</b>	
6.	Tap  .
7.	Tap <b>Import road data</b> .
8.	Tap <b>DXF type</b> .
9.	Polylines from the DXF file are imported and become road axes with the planimetric development but without longitudinal profile or sections. The polylines can be used for stakeout, but without reference to the elevations.
<b>Transformation of a polyline into a road axis or side polyline</b>	
10.	Tap  .
11.	Tap <b>Import road data</b> .
12.	Tap <b>Polyline CAD</b> .
13.	Select a polyline in the graphic window.
14.	The polyline is transformed to a road axes with the planimetric development but without longitudinal profile or sections. The axis can be used for stakeout, but without reference to the elevations.
<b>Importing road project from local format</b>	
15.	Tap  .
16.	Tap <b>Import road data</b> .
17.	Tap <b>Local formats</b> .
18.	Select a format file. Possible formats: <ul style="list-style-type: none"> <li>• <b>REB (Germany)</b> Includes REB DA21 for vertical alignments, REB DA40 for horizontal alignments, REB DA45, DA58, REB DA66 for cross-sections</li> <li>• <b>CLIP (Spain)</b></li> <li>• <b>ISTRAM/ISPOL (Spain)</b></li> <li>• <b>Fiksu (Finland)</b></li> <li>• <b>XRoad (Finland)</b></li> </ul>
19.	All axes and edge polylines are loaded and displayed in the list.

### Creating road data step-by-step

Step	Description
<b>Define the main elements such as horizontal and vertical alignment, cross-sections, super elevation and widening rules.</b>	
1.	Tap  <b>Add</b> .
2.	Enter the road name.
3.	Define the start point defining the starting station and the coordinates. Enter the values manually. OR Tap <b>Point</b> to select an existing topographic point.

Step	Description
4.	Enter <b>Cross section width</b> . This represents the width X-PAD considers when visualising the cross-sections.
<b>Define the horizontal alignment</b>	
5.	Open <b>Horizontal alignment</b> page.
6.	Tap <b>Add</b> .
7.	Select the horizontal element of the design to create. <ul style="list-style-type: none"> <li>• <b>Straight</b> Define the straight element entering azimuth and length, or the final coordinate or point. If a previous element exists, use the button <b>Keep tangent</b> to make this element tangent to the previous one.</li> <li>• <b>Curve</b> Define the curve element entering direction, length and radius, or entering curve center point and end point.</li> <li>• <b>Clothoid</b> Define the clothoid element entering direction, radius and length, parameter A and length.</li> <li>• <b>Clothoid-Curve-Clothoid</b> Define in sequence a clothoid, followed by a curve, followed by a clothoid. Clothoids are defined entering the starting and ending radius and length, or length and parameter A. Curve is defined entering length and radius.</li> </ul>
8.	According to the selected element, enter the required value to define the geometry.
9.	Tap <b>Accept</b> to save the element.
10.	Tap <b>Add</b> to add the following alignment element..
<b>Define the vertical alignment</b>	
11.	Open <b>Vertical alignment</b> page.
12.	Tap <b>Add</b> .
13.	Tap <b>PVI</b> to add the first PVI.
14.	Define the PVI entering the station where PVI is defined and the elevation.
15.	Tap <b>Accept</b> to save the entries.
16.	Tap <b>Add</b> to enter following elements. <ul style="list-style-type: none"> <li>• <b>PVI</b> Define the PVI entering the station where PVI is defined and the elevation.</li> <li>• <b>Parabola</b> Define the parabola entering the length of the parabola element. Enter the elevation and the radius of its vertex.</li> <li>• <b>Curve</b> Define the curve by entering the length or the radius of the curve element. Enter the elevation and the radius of its vertex.</li> </ul>
<b>Define the cross sections</b>	
17.	Open <b>Cross-sections templates</b> page.
18.	Tap <b>Add</b> .
19.	Enter the station to which to start the application of the cross-section model. Select the left and right sides of the cross section selecting it from list of existing cross sections templates. Refer to <a href="#">23.5 X-Section Templates</a> for more information to create cross sections templates.
20.	Define the PVI entering the station where PVI is defined and the elevation.
21.	Tap <b>Save</b> .
22.	The cross section is used until next defined station.
<b>Define the superelevations</b>	
23.	Open <b>Superelevations</b> page. The tab allows to specify the superelevations (side slope) to be used in the elements of the section model.
24.	Tap <b>Add</b> .
25.	Enter the station to which refer the values of the superelevation. Enter the left superelevation. Enter the right superelevation.
26.	Tap <b>Save</b> to save the entries.

Step	Description
<b>Define the widenings</b>	
27.	Open <b>Widenings</b> page. The tab allows to specify the widenings to be used in the elements of the section model.
28.	Tap <b>+ Add</b> .
29.	Enter the station to which refer the values of the widening. Enter the left widening. Enter the right widening.
30.	Tap <b>Save</b> to save the entries.

Once the models of the sections to be used and the superelevation values have been defined, the program is able to determine the project cross-section for any chainage: By the chainage the model section is obtained and the interpolated values of superelevation and widening are applied to the corresponding elements of the section model.

The calculated values of superelevation and widening are applied only to elements of the model section that are identified as items to rotate and enlarge.

**Station equations**

Forward and backward station equations are available to adjust stations along an alignment.

Chainage or station equations are used to adjust the alignment chainage or station. The most common reason for doing so is the insertion or removal of curves during the design process. Inserting or removing a curve would require recalculating the chainage or station of an entire alignment. Using chainage or station equations eliminates this need. Chainage or station equations can create either a gap or an overlap as shown in the following diagrams.

Gap chainage or station equation  
 Chainage or station back 10 = chainage or station ahead 15

- a Old
- b New

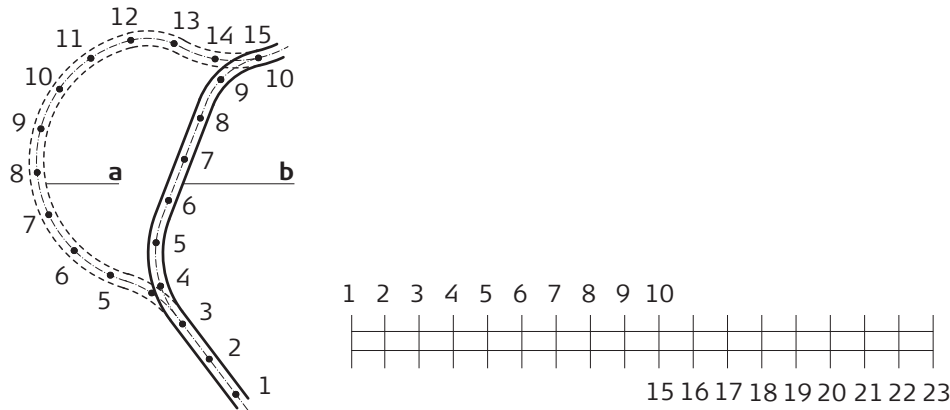

Road\_062

Overlap chainage or station equation  
 Chainage or station back 13 = chainage or station ahead 7

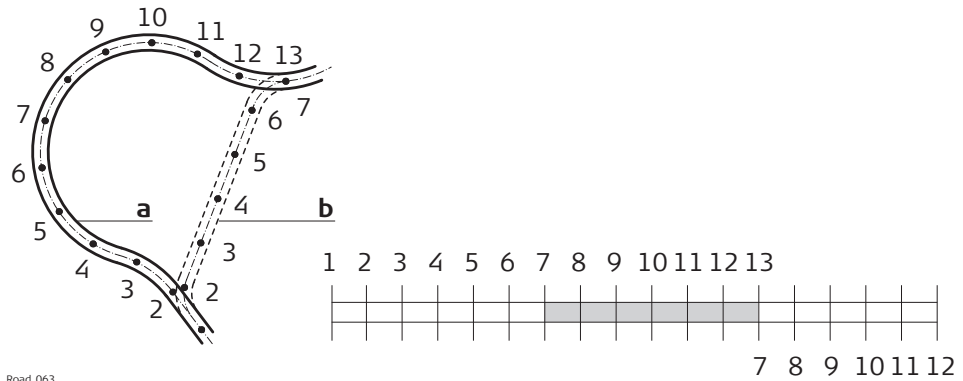

- a New
- b Old



Road\_063

### Editing a road axis step-by-step

Editable		Not editable	
<ul style="list-style-type: none"> <li>• Adding additional information to the design. For example:                             <ul style="list-style-type: none"> <li>• Section models to be used</li> <li>• Raising in curves</li> <li>• Widening in curves</li> </ul> </li> </ul>		<ul style="list-style-type: none"> <li>• Project elements of the horizontal track</li> <li>• Project elements of the vertical track (profile)</li> </ul>	
Step	Description		
1.	Select the axis to be edited.		
2.	Tap <b>Modify</b> . The project data is organised in pages.		
<b>Road page</b>			
3.	<ul style="list-style-type: none"> <li>• <b>Name</b> Name of the axis</li> <li>• <b>Start Station.</b> Chainage of beginning of the axis</li> <li>• <b>East / North</b> Coordinates of the starting point of the axis</li> </ul>		
<b>Horizontal alignment page</b>			
4.	Listed are the planimetric elements of the project. The graphic window displays the planimetric track. The selected element is brought to the front in the graphic window.		
<b>Vertical alignment page</b>			
5.	Listed are the longitudinal elements of the project. The graphic window displays the altimetry track. The selected element is brought to the front in the graphic window.		
<b>Cross sections page</b>			
6.	Listed are the the cross sections of the project.		
7.	Tap <b>View</b> to obtain a list of the coordinates for the lines and vertexes composing the cross section.		
8.	The list of vertexes for each cross section element is displayed in a new window.		
9.	Tap <b>☒</b> .		
10.	Tap <b>Play</b> .		

Step	Description
11.	<p>The cross sections are displayed in sequential order.</p> <ul style="list-style-type: none"> <li>• <b>Station</b> Sets the station from which to start the sequence. When the sequence is started, the station of the axis is displayed in the preview.</li> <li>• <b>Interval</b> Set the station interval.</li> </ul> <p> Activates the sequence.</p> <p> Stops the sequence.</p>

---

**Cross-sections templates** page

12.	<p>Additional cross-sections can be defined. Specify the section models to be used along the track.</p> <ul style="list-style-type: none"> <li>• <b>Chainage</b> Chainage from which on the section model is applied</li> <li>• <b>Left</b> Section model to be used on the left side of the section</li> <li>• <b>Right</b> Section model to be used on the right side of the section</li> </ul>
13.	<p>The defined section model is applied by the chainage of application until the end of the track, or until the next interval.</p>

---

**Superelevation** page and **Widenings** page

14.	<p>Specify the superelevations (side slope) and widenings to be used in the elements of the section model.</p> <ul style="list-style-type: none"> <li>• <b>Chainage</b> Chainage to which refer the values of superelevation and widening</li> <li>• <b>Left</b> Left superelevation and widening</li> <li>• <b>Right</b> Right superelevation and widening</li> </ul>
15.	<p>Once the models of the section to be used and the superelevation values have been defined, the program is able to determine for any chainage the project cross-section.</p> <p>By the chainage, the model of the section is obtained. The values of superelevation and widening are interpolated and applied to the corresponding elements of the section model.</p> <p>The calculated values for superelevation and widening are applied only to those elements of the section model that are identified as items to rotate and enlarge.</p>

---

**Road edges** page

16.	<p>Define, among all polylines of side, those which belong to the axis and which must be used to obtain the cross section.</p> <p>At each chainage, the program performs an intersection with the side polylines to obtain the cross section to be used in stakeout.</p>
-----	--

**Deleting a road axis step-by-step**

Step	Description
1.	Select the axis or side polyline from the list.
2.	Tap <b>Delete</b> . All axis data are deleted.

## 23.2





### Description

### Stakeout

Stakeout of a road axis is similar to stakeout of an element by chainage and offset.

After having selected the reference axis, specify the chainage and the stakeout distance.

## Staking out a road axis step-by-step

Step	Description
1.	Tap <b>ROADS</b> .
2.	Tap <b>Road Stakeout</b> .
3.	Select the reference axis.
4.	Define the chainage and the stakeout distance. <ul style="list-style-type: none"> <li>• <b>Chainage</b> Stakeout chainage</li> <li>• <b>Interval</b> Interval to use for the chainage increase</li> <li>• <b>Surface</b> When cross sections are available, specify the section line to be used for stakeout.</li> </ul>
5.	According to the entered chainage, the corresponding cross section is interpolated and displayed.
6.	For the calculated section, specify the distance from the axis. <ul style="list-style-type: none"> <li>• <b>Offset</b> Vertex of the section to stakeout. Select from the graphic view.</li> <li>• <b>Offset</b> Distance from the axis. Add an additional offset.</li> <li>• <b>Slope from segment</b> When entering an offset. Defines the offset with the same slope of the previous or following segment from the reference point.</li> <li>• <b>Elev.</b> Elevation of stakeout. Add an additional vertical offset. <ul style="list-style-type: none"> <li>•  Activates the display preview of plane alignment elements.</li> <li>•  Activates the display preview of longitudinal profile.</li> <li>•  Activates the display preview of cross sections.</li> </ul> </li> </ul>
7.	The procedure continues with the same functions explained in the chapter on stakeout. Refer to <a href="#">14 GPS - Stakeout</a> and <a href="#">19 TPS - Stakeout</a> .
8.	Tap  <b>Store point</b> to create a new topographic point at the calculated position in order to perform additional operations and calculations.
9.	Select the next point directly in the stakeout panel.

## 23.3

### Side Slopes

#### Description

Calculate and stakeout the point of intersection of the project side slope with the existing terrain.



The position is calculated on the basis of a slope of project and referring to a chainage and to a distance (offset) on the reference axis.

#### Staking out a side slope step-by-step

Step	Description
1.	Tap <b>ROADS</b> .
2.	Tap <b>Sideslope stakeout</b> .
3.	The requests that are performed are exactly the same as for stakeout. Refer to <a href="#">23.2 Stakeout</a> . A tab for the definition of the slopes is added.

**Slopes**





Step	Description
4.	<p>Define:</p> <ul style="list-style-type: none"> <li>• <b>Cut</b> Slope value in the cut condition. The receiver elevation is above the starting elevation of the side slope.</li> <li>• <b>Fill</b> Slope value in the fill condition. The receiver elevation is below the starting elevation of the side slope.</li> <li>• <b>Slope from segment</b> The slope value is calculated according to the selected segment. The side slope is considered as an extension of the segment. It could be useful to place the stake not exactly on the correct position but more external with an additional offset. The offset has to maintain the slope of the segment. If the stake has to be placed 1 m out of the correct position, the elevation is calculated considering the current slope of the segment.</li> </ul> <p>Activates the display preview of plane alignment elements.</p>  <p>Activates the display preview of longitudinal profile.</p>  <p>Activates the display preview of cross sections.</p> 
5.	Tap <b>Next</b> to start staking out of the calculated position.

### Stakeout procedure

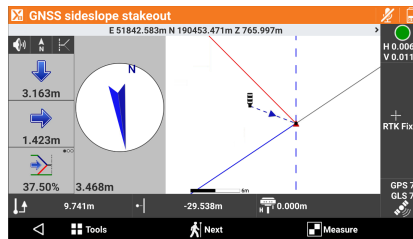
- After having defined the reference element, the offset parameters and slopes, the main stakeout window appears.



In addition to the visualisation mode described in previous paragraphs, this graphical view contains the cross section of the side slope and current position. To change the visualisation mode tap the icons , , and .



The side panel contains the information to get the point of intersection. First value refers to the vertical distance from the position to side slope. Second value refers to the horizontal distance from the position to side slope. Third value shows the current value of the slope and the direction to take, on the perpendicular to the reference element, to achieve the project slope value.

It is possible to change the shown information: hit it or scroll.

- Select the next point directly in the stakeout panel.

## 23.4

### Current Position

#### Description

Provides information about the current position in relation to the selected road project (road design) or a 3D surface.

#### Current position step-by-step

Step	Description
1.	Tap <b>ROADS</b> .
2.	Tap <b>Where am I?</b>
3.	Select the road design or the 3D surface.

Step	Description
4.	Select the reference axis to be used for the calculation. The reference axis can be any line, not necessarily the centre line.
5.	When using a total station, measure to have a position of calculation.
6.	Basing on the position, information is displayed. <ul style="list-style-type: none"> <li>• Chainage of the current position</li> <li>• Distance from the reference axis</li> <li>• Element of the plane track</li> <li>• Element of the altimetry track</li> <li>• Absolute elevation, axis elevation, elevation difference</li> <li>• Right or left side of the track</li> </ul>

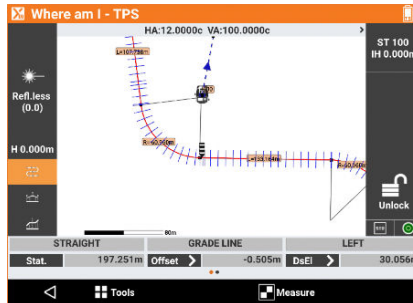

- Change the view by tapping on the points at the bottom of the view. Further information is displayed:
  - **Surface**  
Change the surface
  - **Reference**  
Annotation with the possibility to switch to multiple values

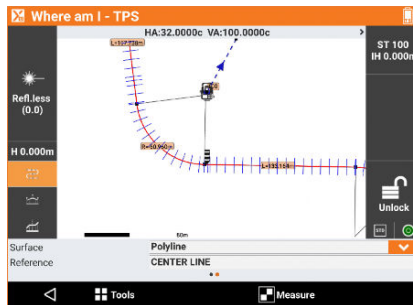

- Three graphic views are available:
  - Plane
  - Profile
  - Section

## 23.5

### X-Section Templates

#### Description

Defines the shape and the characteristics of the section to be applied along a track

Through the composition of simple linear elements, it is also possible to define models of complex sections that can be subject to superelevations and widenings in curves.



The section model must be defined only for the right side of the section. The definition can then be used for the left side.

#### X-section template step-by-step

Step	Description
1.	Tap <b>ROADS</b> .
2.	Tap <b>X-Sections Templates</b> .
<b>General</b> page	

Step	Description
3.	<p>Define the section model name and distance of the point of rotation.</p> <ul style="list-style-type: none"> <li>• <b>Name</b> page Name of the section model</li> <li>• <b>Rotation Point</b> Distance of the point of rotation referring to the central axis of the project. <ul style="list-style-type: none"> <li>• <b>Double pitch roadway</b> The point of rotation coincides with the axis of the road. The distance of the point of rotation is 0.</li> <li>• <b>Separated roadways with rotation of roadways at the inner edge</b> The distance of the point of rotation coincides with the width of the internal edge.</li> <li>• <b>Separated roadways with rotation in correspondence of the axis of each roadway</b> The distance of the point of rotation corresponds to the width of the inner edge plus the width of the half-roadway</li> </ul> </li> </ul>

---

#### Vertices page

---

4.	<p>Define the section shape. Each vertex is defined by the horizontal and vertical distance referring to the previous vertex.</p> <ul style="list-style-type: none"> <li>• <b>Type</b> Type of input <ul style="list-style-type: none"> <li>• <b>Offset X &amp; Y</b> Horizontal and vertical distance</li> <li>• <b>Offset X &amp; Slope</b> Horizontal distance and slope</li> </ul> </li> <li>• <b>Offset X</b> page Horizontal vertex distance from previous vertex</li> <li>• <b>Offset Y</b> page Vertical vertex distance from previous vertex</li> <li>• <b>Slope</b> page Slope of the vertex from previous vertex</li> <li>• <b>Apply Superelevation &amp; Widening</b> page Applies the superelevation and widening values on the segment. Enable this option for parts which represent the roadway.</li> </ul>
----	--

---

#### Editing an X-section template step-by-step

Step	Description
1.	Select an template from the list.
2.	Tap <b>Modify</b> .

---

#### Deleting an X-section template step-by-step

Step	Description
1.	Select an template from the list.
2.	Tap <b>Delete</b> .

---

## 23.6

### Report

#### Stake out report step-by-step

All stakeout data related to stakeout of points or elements are recorded in the job.

This command allows reading and exporting the data to a file \*.csv extension that can be opened also with software such as Microsoft Excel.



Step	Description
1.	Tap <b>ROADS</b> .
2.	Tap <b>Stakeout report</b> .
3.	A table presents the list of all stakeout points with differences, in distances and elevations, between the design coordinate and the stakeout coordinate.
4.	Tap  <b>Share</b> to create an ASCII, CSV, XML, PDF or HTML document, with all stakeout data of every point.

---

**Description**

Within the software, it is possible to enter the login details of the X-PAD 365 account, always be automatically connected to receive messages in chat and notifications and to have access to the storage area.

**Login to X-PAD 365 step-by-step**

Step	Description
1.	Tap <b>JOB</b> .
2.	Tap <b>X-PAD 365</b> .
3.	Tap  .
4.	<b>Profile</b> page <ul style="list-style-type: none"> <li>• <b>UserID</b> Identification of the user registered to the service</li> <li>• <b>Password</b> Password assigned to the registered user by the service</li> <li>• <b>Automatic login</b> Activate an automatic login when accessing this panel.</li> </ul>
5.	Tap <b>Login</b> .
6.	Tap  .
7.	<b>Tools</b> page <ul style="list-style-type: none"> <li>• <b>X-PAD 365.com</b> Access to X-PAD 365 web portal</li> <li>• <b>Collaborative</b> Survey or stakeout on the same project by different users at the same time</li> <li>• <b>Assets</b> Register hardware and licenses to keep the information available in one place.</li> <li>• <b>Technical resources</b> Access to technical and educational resources available in the field</li> <li>• <b>Backup &amp; Restore</b> Make a copy of the settings and job data so that they can be restored if necessary.</li> <li>• <b>Used:</b> and <b>Free</b> Information about the storage area</li> </ul>

**Notifications step-by-step**

Notifications are received with immediate access to the content.

Step	Description
1.	Tap  .
2.	<b>Notification</b> page <ul style="list-style-type: none"> <li>• Licence related information</li> <li>• Expiry date</li> <li>• Low disk space</li> <li>• Revision required for the hardware</li> <li>• Manual notifications sent to defined users (distribution partners) with important information related to the hardware or the software</li> </ul>

**X-CHAT step-by-step**

X-CHAT is a communication channel between X-PAD 365 users and is fully integrated in X-PAD Ultimate and in X-PAD Fusion.



X-CHAT replaces the X-Live solution.

Step	Description
1.	Tap  .
2.	Possible is: <ul style="list-style-type: none"> <li>• Exchange messages among single users and groups of users</li> <li>• Exchange files among single users and groups of users.</li> </ul>

**Collaborative survey or stakeout in X-PAD 365 step-by-step**

Any connection must be configured previously. Each user can invite another as described below.

Multiple users can cooperate together to complete a survey or stakeout activity.

Collaborative survey session	Collaborative stakeout session
One user invites other users to cooperate on the same job file.	
Stored points and drawings are shared in real-time with all participants.	When a point is successfully staked out, its status changes for all participants in real-time.
Each participant can see what the others are doing.	
	Useful for big projects where multiple teams are working simultaneously.

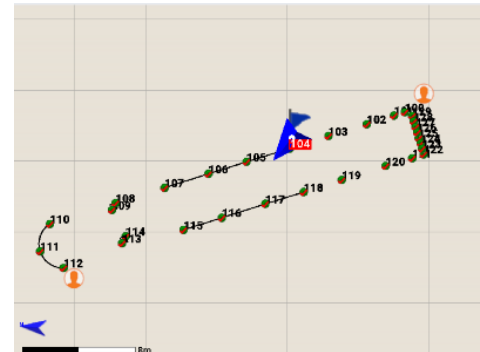
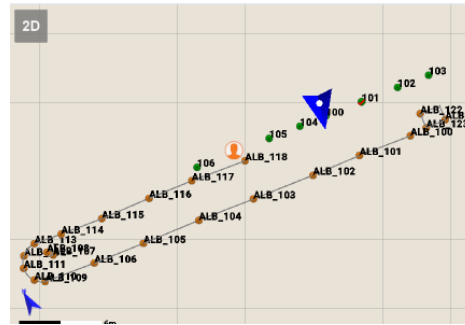

Step	Description
1.	Tap <b>Collaborative</b> in the <b>Tools</b> menu.
2.	Select: <ul style="list-style-type: none"> <li>• <b>Collaborative survey</b></li> <li>• <b>Collaborative</b></li> </ul>
3.	As initiator, tap <b>New session</b> . As participant, tap <b>Join session</b> .

### Assets in X-PAD 365 step-by-step

The X-PAD Ultimate license and all hardware devices connected can be registered in X-PAD 365. Having the software and the hardware registered means that all information is stored and maintained in one place.

Notifications about the license expiry date and specific information related to the registered hardware is sent.

Step	Description
1.	Tap <b>Assets</b> in the <b>Tools</b> menu.
2.	Tap  .
3.	Enter: <ul style="list-style-type: none"> <li>• <b>EquipmentID</b> The equipment number of the hardware to register</li> <li>• <b>Serial</b> The serial number of the hardware to register</li> </ul>
4.	Tap <b>Accept</b> .
5.	Tap on a registered item to display related information.

### Technical and educational resources available in the field step-by-step

GeoMax academy has prepared many technical and educational resources related to X-PAD Ultimate. Videos and documents explain in detail how to work with the software. X-PAD 365 users can access these resources not only via the web platform, but also directly in the field from X-PAD Ultimate.

Step	Description
1.	Tap <b>Technical resources</b> in the <b>Tools</b> menu. The information is organised in pages.
2.	Tap  to open a resource.

**Backup and restore in X-PAD 365 step-by-step**

Tablets and controllers are exposed to some risks especially when they are used in construction sites. They can be irreparably damaged or stolen. In both cases, data is lost with all consequences.

The backup and restore function allows:

- Make a copy of the settings in X-PAD 365
- Make a copy of the job data in X-PAD 365
- Restore the items if necessary
- Transfer data and settings from an old controller to a new one

 A Wi-Fi connection is required.

Step	Description
1.	Tap <b>Backup &amp; Restore</b> in the <b>Tools</b> menu. The information is organised in pages.
<b>X-PAD 365 backup</b> page	
2.	<ul style="list-style-type: none"> <li>• <b>Device name</b> The device from which a backup must be done.</li> </ul>
3.	Tap <b>+</b> to create a new backup.
<b>Automatic</b> page	
4.	<p>Allows to save the most updated data in X-PAD 365 and be able to restore when needed. The automatic backup procedure checks for files and data that are changed since the previous backup and upload these changes to X-PAD 365. Define:</p> <ul style="list-style-type: none"> <li>• <b>Device name</b> Name of the hardware from which the backup was done.</li> <li>• <b>Last automatic backup</b> Date and time of the last backup.</li> <li>• <b>Files copied</b> Number of files saved.</li> <li>• <b>Automatic backup status</b> Indicates if the backup was successful.</li> </ul>
5.	Tap <b>Start service</b> .

**Organising the storage area in X-PAD 365 step-by-step**

The amount of cloud space available depends on the X-PAD 365 subscription. The cloud space can be managed through this section.

Step	Description
1.	Tap <b>Used:</b> and <b>Free:</b> in the <b>Tools</b> menu.
2.	Use the file manager for import and export operations. The X-PAD 365 Professional or Enterprise account allows to manage and organise the storage area.

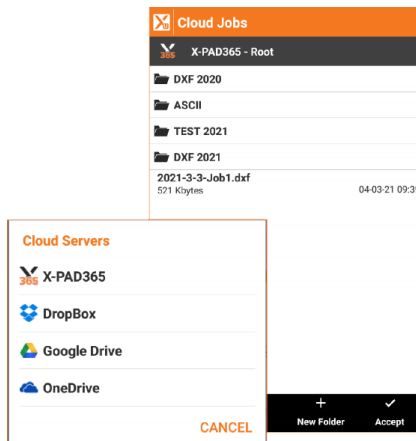

3. Notifications are sent when the remaining free space is running low.

**Description**

External references are connections that are created between:

- The current job and other jobs of X-PAD
- The current job and other data files in AutoCAD DXF format
- The current job and other data files in raster maps

Instead of importing data to the current job, it is possible to manage the reference to the data and load it temporarily when needed. When opening the main job, the data can be loaded from the linked files.

External reference is a very flexible way of managing the data required for the phases of the job. The external references allow:

- Loading only what is needed without changing the main file
- Loading the updated version of the reference file
- Sharing the same reference files between multiple jobs



The elements imported by an external reference cannot be modified.

After defining a reference to an external file, the following actions can be done:

Action	Description
Download data	The reference remains active but the data is downloaded from the memory.
Load data	Load the data file to the memory
Change visibility status	Make the external reference data visible or invisible
Restore link	If the external reference file has been moved to a new folder, it is possible to specify the new location and to restore the connection.

Step	Description
1.	Tap <b>JOB</b> .
2.	Tap <b>External references</b> .

**Adding an external reference step-by-step**

Step	Description
1.	Tap <b>New</b> .
2.	A new reference is added to an external document that is uploaded along with the current job.
3.	Define: <ul style="list-style-type: none"> <li>• <b>[SWNAME] document</b> or <b>AutoCAD DXF</b> or <b>Raster map</b> Select the type of document to be added as an external reference.</li> </ul>

**Importing an AutoCAD DXF file or an X-PAD job step-by-step**

Step	Description
1.	Select folder and file to load.

Step	Description
2.	Define: <ul style="list-style-type: none"> <li>• <b>Mode</b> Choose between importing all data of the selected document into a single layer or keeping the original layer</li> <li>• <b>Layer</b> Only one layer to use to group the document data</li> <li>• <b>Layer color</b> Colour of the layer</li> <li>• <b>Use original colors</b> Load all data on a single layer and keep the original color of the drawing</li> <li>• <b>Import points</b> Add points of the document list to the jobs points</li> <li>• <b>Points prefix</b> Prefix to be added to the names of the points loaded from the document</li> </ul>
	The DWG drawings with cartographic coordinates are not supported. In this case it is required to use the AUTOCAD DXF format.

### Import an IFC file step-by-step

The IFC format file (Industries Foundation Classes) is the reference for the BIM methodology. Files of this type have a data structure divided into classes. Each class contains objects. Using an IFC file as an external reference makes all classes and objects available in the CAD window, that are in the IFC file. In the project manager, it is possible to handle the visibility status of a class or objects.



DWG and IFC files cannot be imported by X-PAD Ultimate in controllers equipped with Android version lower than 5. All other features are still available for all controllers with Android higher or equal to 4.1.

### Importing a raster image step-by-step

Step	Description
1.	Select folder and file to load.
2.	Define position and scale: <ul style="list-style-type: none"> <li>• <b>Top-left corner</b> Coordinates of the top-left corner in which to position the image</li> <li>• <b>Scale map 1:</b> Scale factor to assign to the map for correct representation</li> <li>• <b>Map width</b> Width of the image in real coordinates</li> <li>• <b>Map height</b> Elevation of the map in real coordinates</li> </ul>
3.	If the file of the image comes with the World file, the positioning parameters allowing to visualise the image in the correct position and dimension are just visualised.

### Deleting an external reference step-by-step

Step	Description
1.	Select document.
2.	Tap <b>Delete</b> .
3.	The external document data is downloaded and the reference to the external document is deleted.

### Loading external reference data step-by-step

Step	Description
1.	Select document.
2.	Tap <b>Load</b> .
3.	The external document data is loaded into the current document.

### Downloading data of an external reference step-by-step

Step	Description
1.	Select document.
2.	Tap <b>Unload</b> .





---

Step	Description
3.	The data is downloaded to the current document and the memory is cleaned up. The reference to the external document remains.

---

### Changing visibility status of an external reference step-by-step

In the graphic window, it is possible to manage the visualisation of the external documents.

Step	Description
1.	Visible external documents are marked by  . Invisible external documents are marked by  .
2.	Click the symbol to change the visibility of an external document.

---

### Reconnecting an external reference step-by-step

An external document can change the storage path and be present in another folder.

Step	Description
1.	Select document to recover the link.
2.	Select the item.
3.	Tap <b>Connect</b> .
4.	Specify the new file path.

---

**Description**

Import procedures allow to load points, drawings and other information from files in several format types. Files to import can be present in device folders or on cloud servers.

**Importing an AutoCAD DXF/DWG file or a job step-by-step**

A DXF/DWG file containing drawing information and points can be loaded in the current job.



DWG and IFC files cannot be imported by X-PAD Ultimate in controllers equipped with Android version lower than 5. All other features are still available for all controllers with Android higher or equal to 4.1. Controllers with architecture ARM64-v8A fully support DWG import. All latest generations of controllers support this architecture.

Step	Description
1.	Tap <b>Job</b> .
2.	Tap <b>Import data</b> .
3.	Tap <b>AutoCAD DXF/DWG file import</b> .
4.	Select the DXF file to load.
5.	Define the import options regarding topographic points.

**Imports as topographic points**

- 6.
  - **Drawing points**  
Activates the import of drawing points (POINT entity) as topographic points
  - **Blocks**  
Activates the import of blocks and block reference (INSERT entity)
    - **No**  
No import
    - **As topographic points**  
The information from blocks is imported as simple points.
    - **As blocks**  
Blocks are imported as reference of the corresponding block
    - **Exploded**  
Block references are extracted to the original basic entities.
  - **Recognize name**  
Activates the automatic recognition of the name of the point by searching of a text near the point. For every point to import, the software checks if a text exists near the position of the point. The text found is identified as the name of the point. Activate this option to keep the original point names from the drawings in DXF format.
  - **Objects vertexes**  
Activates the automatic creation of topographic points on objects vertexes.
  - **Start name**  
Name to assign to the first point that is imported.





**Import options**

- 7.
  - **Invisible layers**  
Allows to import layers that are invisible in the CAD file.
  - **Select layers to import**  
Allows to choose the layers for import in a separate window.
  - **Import 3D**  
Activates the import of CAD entities including information related to the elevation. If this option is not active, all entities are imported with an elevation of zero.
  - **Distance unit**  
Set the unit for the measurements of the drawing. During the import, the software performs the conversion in the unit of the job.

**Importing from file in ASCII format step-by-step**

Import a file of points in text format as topographic points or reference points. Import parameters can be saved in a template which can be loaded for other import and export procedures.

Step	Description
1.	Tap <b>Job</b> .
2.	Tap <b>Import data</b> .
3.	Tap <b>Text file (ASCII)</b> .
4.	Select the text file to load.

Step	Description
5.	Define the import options regarding topographic points.
6.	Define the parameters: <ul style="list-style-type: none"> <li>• <b>Data</b> Select if you want to load the points as topographic points or as reference points. <ul style="list-style-type: none"> <li>• Topographic points</li> <li>• Reference points</li> <li>• Codes</li> </ul> </li> <li>• <b>Schema</b> The currently available import scheme is suggested. Select a scheme or choose <b>* Customized *</b> to create a scheme.</li> <li>• <b>Separator character</b> Character separating fields with content</li> <li>• <b>Heading rows</b> Number of rows composing the heading in the file. Heading rows are not imported.</li> <li>• <b>Overwrite points</b> The existing points are deleted during the import phase.</li> <li>• <b>Layer</b> The layer in which the points are saved. Selecting a layer allows a logical organisation of the points.</li> </ul>
7.	The list of the fields that can be imported is displayed in a table.
8.	For <b>* Customized *</b> scheme: Select the fields to import and change the order using the buttons. <div style="margin-left: 20px;">  Select fields to import </div> <div style="margin-left: 20px;">  Move the selected field up </div> <div style="margin-left: 20px;">  Move the selected field down </div>
9.	A preview of the importing result is displayed.
10.	For <b>* Customized *</b> scheme: <ul style="list-style-type: none"> <li>• <b>Save scheme</b> To save the settings in a scheme.</li> <li>• <b>Name</b> Name of the scheme to create</li> </ul>  Import and export schemes are saved as files with *.psc extension in the \SCHEMES folder of the software.
11.	Tap <input checked="" type="checkbox"/> to start the import procedure.

### Importing from files in GSI format step-by-step

Step	Description
1.	Tap <b>JOB</b> .
2.	Tap <b>Import data</b> .
3.	Tap <b>GIS data</b> .
4.	Select the GSI file to load.
5.	Specify to import data as topographic points or as reference points.

### Importing from files in LandXML format step-by-step

LandXML can include several types of data: topographic points and measurements, terrain and design surfaces, road design data. All types of data saved in a LandXMLfile and imported.

Step	Description
1.	Tap <b>JOB</b> .

Step	Description
2.	Tap <b>Import data</b> .
3.	Tap <b>LandXML Format</b> .
4.	Select the LandXML file to load.

#### Importing from files in ESRI Shape format step-by-step

From ESRI shape format, points, polylines and polygons can be imported.

Step	Description
1.	Tap <b>JOB</b> .
2.	Tap <b>Import data</b> .
3.	Tap <b>ESRI Shape file</b> .
4.	Select the shape file to load.

#### Importing from files in Google Earth KML/KMZ format step-by-step

Step	Description
1.	Tap <b>JOB</b> .
2.	Tap <b>Import data</b> .
3.	Tap <b>Google Earth KML/KMZ</b> .
4.	Select the file to load.

#### Importing a raster map step-by-step

Import a file for a map in raster format. When also a Word file with visualised positioning parameters is available, the image is displayed with the correct positions and dimensions.

Step	Description
1.	Tap <b>JOB</b> .
2.	Tap <b>Import data</b> .
3.	Tap <b>Raster image</b> .
4.	Select the folder and the file of the image to load.
5.	Define position and scale: <ul style="list-style-type: none"> <li>• <b>Top-left corner</b> Coordinates of the top-left corner of the image</li> <li>• <b>Scale map 1:</b> Scale with which the image is acquired</li> <li>• <b>Map width</b> Width of the map in real coordinates</li> <li>• <b>Map height</b> Elevation of the map in real coordinates</li> </ul>
6.	The image is displayed in the graphic window of the CAD.

#### Importing from file in Trimble DC format step-by-step

From Trimble DC format, points and calibrations of the GPS site can be imported.

Step	Description
1.	Tap <b>JOB</b> .
2.	Tap <b>Import data</b> .
3.	Tap <b>Trimble DC</b> .
4.	Select the file to load.

#### Importing from file in SurvCE RW5 format step-by-step

From SurvCE RW5 format, points and calibrations of the GPS site can be imported.

Step	Description
1.	Tap <b>JOB</b> .
2.	Tap <b>Import data</b> .

**Importing from file in Sokkia SDR format step-by-step**

---

Step	Description
3.	Tap <b>SurvCE RW5</b> .
4.	Select the file to load.

---

---

Step	Description
1.	Tap <b>JOB</b> .
2.	Tap <b>Import data</b> .
3.	Tap <b>Sokkia SDR Format</b> .
4.	Select the file to load.

---

**Description**

Export procedures allow exporting points, drawings and other information to files in various formats. Exported files can be used in other applications. Exported files can be shared and opened directly.

**Common settings for all formats**

Step	Description
1.	Tap <b>JOB</b> .
2.	Tap <b>Export &amp; Share</b> .
3.	Define: <ul style="list-style-type: none"> <li>• <b>Device/Cloud</b> Files can be exported to the controller or saved in a cloud platform. When saving to the controller, define the folder in which to save the file.</li> <li>• <b>Share file</b> The file can be sent to other users in different ways:                             <ul style="list-style-type: none"> <li>• E-mail</li> <li>• Bluetooth</li> <li>• WiFi</li> <li>• Other modes available on the controller</li> </ul> </li> <li>• <b>Open with</b> For some formats, the files can be opened and visualised directly with apps available on the controller.</li> </ul>

**Exporting a file in X-PAD exchange format step-by-step**

The format ensures better data transfer and collaboration between office and field software:

- X-PAD Ultimate Survey
- X-PAD Ultimate
- X-PAD Office Fusion

Step	Description
1.	Tap <b>Job</b> .
2.	Tap <b>Export &amp; Share</b> .
3.	Tap <b>X-PAD Exchange</b> .
4.	The format consolidates all information stored in the field including photos and raw data.

**Exporting a file in X-PAD Office Fusion format step-by-step**

Export the points of the job and the drawing to X-PAD Office Fusion format.

Step	Description
1.	Tap <b>JOB</b> .
2.	Tap <b>Export &amp; Share</b> .
3.	Tap <b>X-PAD Office Fusion</b> .
4.	All job files, including images associated with the points, are combined into a single file with XPAD extension. The file can be imported with the office software X-PAD Office Fusion.

**Exporting a file in AutoCAD DXF format step-by-step**

Export the points of the job and the drawing in AutoCAD DXF format, also in AutoCAD 2018.





Step	Description
1.	Tap <b>JOB</b> .
2.	Tap <b>Export &amp; Share</b> .
3.	Tap <b>AutoCAD DXF</b> .
<b>Other</b>	

Step	Description
4.	<ul style="list-style-type: none"> <li>• <b>Version</b> Version of the DXF format to create.</li> <li>• <b>Survey drawing</b> Activate the export of all the drawing elements that were created during the measurement operations with <b>Smart drawing</b>.</li> <li>• <b>Drawing</b> Activates the export of the drawings in the job.</li> <li>• <b>Export 3D</b> Activates the export of data with elevation.</li> </ul>
<b>Points</b>	
5.	<ul style="list-style-type: none"> <li>• <b>Export points</b> Activates the export of topographic points</li> <li>• <b>Labels size (m)</b> Size of the text for the labels of the topographic points</li> <li>• <b>Block with attributes and symbol</b> Activates the export of topographic points as AutoCAD blocks with attributes</li> <li>• <b>Export sketches</b> Activates the export of the images associated with the points. The images are linked to the points to be opened as a reference (hyperlink) from AutoCAD.</li> <li>• <b>Export X-Live points</b> Activates the export of measured points also by the other members of the X-Live team and that have been shared in the session.</li> <li>• <b>Labels on layer of points</b> Activates the export of all labels on the same layer of the reference point.</li> </ul>
<b>Labels to export</b>	
6.	<ul style="list-style-type: none"> <li>• <b>Point Name</b> Activates the export of the label with point names</li> <li>• <b>Point Elevation</b> Activates the export of the label with point elevations</li> <li>• <b>Point Code</b> Activates the export of the label with point codes</li> <li>• <b>Point Description</b> Activates the export of the label with point descriptions</li> </ul>

### Exporting a file in ASCII format step-by-step

Export topographic points, reference points and TPS measurements in ASCII customisable format. Export parameters can be saved in a template which can be loaded for other import and export procedures.

Step	Description
1.	Tap <b>JOB</b> .
2.	Tap <b>Export &amp; Share</b> .
3.	Tap <b>Text file (ASCII)</b> .
4.	Define the parameters: <ul style="list-style-type: none"> <li>• <b>Data</b> Select the type of data to export: <ul style="list-style-type: none"> <li>• Topographic points</li> <li>• Reference points</li> <li>• GPS measurements</li> <li>• TPS measurements</li> <li>• Bathymetric session</li> </ul> </li> <li>• <b>Scheme</b> The currently available export scheme is suggested. Select a scheme or choose <b>* Customized *</b> to create a scheme.</li> <li>• <b>Separator character</b> Character separating fields with content</li> <li>• <b>Heading row</b> Activates the export of a heading row containing the name of the fields.</li> </ul>
5.	Define the decimals: <ul style="list-style-type: none"> <li>• <b>Angles, Coordinates, Elevation and Distances</b> Export data with a number of decimal different from what is defined in the settings and normally used by the application.</li> </ul>
6.	The list of the fields that can be exported is displayed in a table.
7.	For <b>* Customized *</b> scheme: Select the fields to export and change the order using the buttons.

Step	Description
	 Select fields to export
	 Move the selected field up
	 Move the selected field down
8.	A preview of the exporting result is displayed.
9.	For * <b>Customized</b> * scheme: <ul style="list-style-type: none"> <li>• <b>Save scheme</b> To save the settings in a scheme.</li> <li>• <b>Scheme name</b> Name of the scheme to create</li> </ul>  Import and export schemes are saved as files with *.psc extension in the \SCHEMES folder of the software.
10.	Tap <input checked="" type="checkbox"/> to start the import procedure.

### Exporting a file in GSI format step-by-step

Export topographic points, reference points and TPS measurements in GSI format.

Step	Description
1.	Tap <b>JOB</b> .
2.	Tap <b>Export &amp; Share</b> .
3.	Tap <b>GSI format</b> .
4.	Define the parameters: <ul style="list-style-type: none"> <li>• <b>Data</b> Select the type of data to export:               <ul style="list-style-type: none"> <li>• Topographic points</li> <li>• Reference points</li> <li>• TPS measurements</li> </ul> </li> <li>• <b>Export model</b> For topographic points, select an export model:               <ul style="list-style-type: none"> <li>• <b>Points for Phytagoras</b></li> <li>• <b>Points for CodeGrafik (rmData)</b></li> </ul>               For TPS measurements, select an export model:               <ul style="list-style-type: none"> <li>• <b>TPS measurements Phytagoras</b></li> <li>• <b>TPS measurements LSS</b></li> <li>• <b>TPS measurements CodeGrafik (rmData)</b></li> </ul> </li> <li>• <b>Export attributes</b> Activate the export of the point codes as attribute of GSI format</li> <li>• <b>Separator</b> Separator used for composed codes. In the code of the point, more than one code can be saved separated by characters such as point, comma, space or other. During export of attributes, the complete code is divided in sub-codes based on separation characters.</li> <li>• <b>Merge attributes</b> Activates the export of single codes composing the complete code. A separation character is not considered.</li> </ul>
5.	Tap <b>Export GSI</b> to start the export.

### Exporting a file in LandXML format step-by-step

Export:

- Topographic points and reference points in LandXML format
- Surfaces initially created with **Volume & Surface** module



Step	Description
1.	Tap <b>JOB</b> .
2.	Tap <b>Export &amp; Share</b> .
3.	Tap <b>LandXML format</b> .

**Exporting a file in Google Earth KML/KMZ format step-by-step**

Export topographic points and reference points in KML format for Google Earth.

Step	Description
1.	Tap <b>JOB</b> .
2.	Tap <b>Export &amp; Share</b> .
3.	Tap <b>Google Earth KML</b> .
4.	Define: <ul style="list-style-type: none"> <li>• <b>Format</b> Select the KML or KMZ export format. The KMZ format can also export images.</li> <li>• <b>Altitude mode</b> Elevations can be defined in three ways: <ul style="list-style-type: none"> <li>• <b>Clamp to ground</b> Elevation is however leaned to 3D model of Google Earth</li> <li>• <b>Relative to ground</b> Elevations refer to a 3D model of Google Earth</li> <li>• <b>Absolute</b> Elevations are absolute</li> </ul> </li> <li>• <b>Export GIS attributes</b> Activates the export of GIS attributes if present.</li> <li>• <b>Export images</b> Activates the export of the images present in the job.</li> <li>• <b>Image type</b> Choose the type of image to export: <ul style="list-style-type: none"> <li>• Sketch</li> <li>• Original</li> <li>• Tag Image</li> </ul> </li> </ul>
5.	If Google Earth is installed on the device, the content of the file can be opened and displayed.

**Exporting file in Garmin GPX format step-by-step**

Export topographic points and reference points in Garmin GPX format.

Step	Description
1.	Tap <b>JOB</b> .
2.	Tap <b>Export &amp; Share</b> .
3.	Tap <b>Garmin GPX format</b> .

**Exporting a file in ESRI Shape file format step-by-step**

Export topographic points and reference points in ESRI Shape format.

For topographic points which have a photo attached, the points are exported including the name of the photo name as additional attribute. The files of the photos files are included in the final export file. The photos can then be managed within a GIS tool which can import Shape files.

Step	Description
1.	Tap <b>JOB</b> .
2.	Tap <b>Export &amp; Share</b> .
3.	Tap <b>ESRI Shape file</b> .
4.	Choose whether to export coordinates in plane format (ENZ) or as latitude, longitude, altitude (LLH).

**Exporting a file in Leica IDX/IDEX format step-by-step**

Export topographic points and reference points in IDX/IDEX format.

Step	Description
1.	Tap <b>JOB</b> .
2.	Tap <b>Export &amp; Share</b> .
3.	Tap <b>IDX/IDEX format</b> .

### Exporting a file in GVX format step-by-step

Export GNSS measurement data in the new GVX (GNSS Vector Exchange) format.

This NGS (National Geodetic Survey, USA) defined format allows users to integrate RTK Vectors into OPUS-Projects along with static data for combined network least squares adjustment.

Step	Description
1.	Tap <b>JOB</b> .
2.	Tap <b>Export &amp; Share</b> .
3.	Tap <b>GVX format</b> .

### Exporting file in Sokkia SDR format step-by-step

Export topographic points and reference points in Sokkia SDR format.

Step	Description
1.	Tap <b>JOB</b> .
2.	Tap <b>Export &amp; Share</b> .
3.	Tap <b>Sokkia SDR Format</b> .

### Exporting a file in SurvCE RW5 format step-by-step

Export topographic points and reference points in SurvCE RW5 format.

Step	Description
1.	Tap <b>JOB</b> .
2.	Tap <b>Export &amp; Share</b> .
3.	Tap <b>SurvCE RW5</b> .

### Exporting a file in STAR\*NET format step-by-step

Export TPS measurements in STAR\*NET format.

Step	Description
1.	Tap <b>JOB</b> .
2.	Tap <b>Export &amp; Share</b> .
3.	Tap <b>STAR*NET Format</b> .

### Exporting measurements step-by-step

There is no explicit function to export measurements acquired in the field. The information for measurements is not uniform between GPS measurements, hidden points measurements, TPS measures and so on.

However, every time a job is closed, the X-PAD RAW file is created automatically. The RAW file is a text file. It contains:

- The main settings of the job
- The coordinates of the points
- The chronological list of measurements acquired with all the available information



To use measurements and survey data with third party software, use the RAW file. For further information about RAW file format of X-PAD, refer to corresponding guide.

### Exporting measurements step-by-step

Data exports are available in many different formats depending on the selected language. Also new export formats are constantly added.

**Description**

MEP stands for mechanical, electrical, engineering.

It comprises a set of commands:

- Perform plumbing
- Transferring heights
- Creating a parallel line
- Moving on a surface
- Scanning a line

A GeoMax motorised total station is required.

Option	Description
<b>Plumb point</b>	To determine, for the measured point, the corresponding plumb point (toward the top or toward the bottom).
<b>Level point</b>	To get a reference height and transfer it on every other surface. Measure a reference height on the first wall, turn the telescope with the laser pointer to the next wall. The same height is indicated on the wall.
<b>Parallel line</b>	To determine parallel lines to a reference line on every surface. Measure the reference line and define the distance.
<b>Distance &amp; offset</b>	To determine new positions and distances related to a starting point on vertical surfaces. Having a starting point, set a horizontal relative distance and a vertical relative distance. The laser pointer positions itself exactly on the requested point.

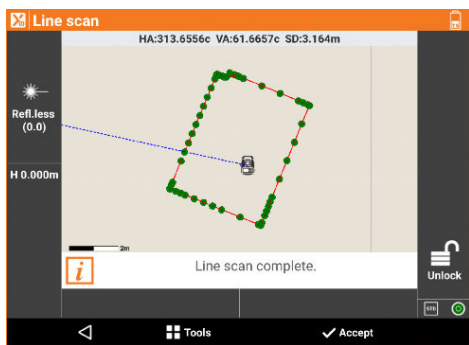

Option	Description
<b>Line scan</b>	To perform automatic measurements by pre-setting distance intervals of a defined plane. The plane can be horizontal, vertical or inclined. The scan can be complete (360°) or partial. The direction changes of the surfaces are determined and vertexes (corners) are measured. The scan interval can be changed while measuring.
	

Step	Description
1.	Tap <b>MEP</b> .

Icons	Description
	<b>Ref. elevation</b> Transfer an elevation from one surface to another surface. The reference elevation can be measured or entered manually.



**975948-1.0.0en**

Original text (975948-1.0.0en)

© 2022 GeoMax AG is part of Hexagon AB.  
All rights reserved.



**GeoMax AG**

Espenstrasse 135  
9443 Widnau  
Switzerland

[geomax-positioning.com](http://geomax-positioning.com)

