

CB.D2.CAN

SINGLE MACHINE CONTROL PANEL WITH AUXILIARY OUTPUT



OPERATOR'S MANUAL





This manual is an important part of your purchase. Please read it thoroughly before using your CB.D2 System.

We recommend that you record details of your purchase here so that the information is readily available if you ever need to contact your supplier.

Serial Number _____

Date of Purchase _____

Purchased from _____

Telephone _____

Facsimile _____

Email _____

Published By:

MOBA Mobile Automation Australia Pty Ltd
90 Willandra Drive
Epping 3076
Victoria, Australia

Copyright © 2020 MOBA Australia

MCE Lasers ® is a registered trademark of MOBA Australia.

All rights reserved. No part of this manual may be reproduced in any form or by any means without prior written permission from the publishers.

July 2020

Stock number: CB.D2

Document number: 012-84-000-17-001-10



WARRANTY

STATEMENT OF LIMITED WARRANTY

MOBA Australia warrants all equipment of its manufacture to be free of defects in material and workmanship for a period of twelve months. This warranty period is twelve months from the date of invoice. Items covered by this warranty are: sensors, transmitters, electronic levels, receivers, masts, control boxes, displays and accessories. All other components not manufactured by MOBA Australia but sold as a part of the installation package, such as hydraulic or electrical components, hoses, fittings and clamps, will carry the original manufacturer's warranty.

MOBA Australia or its authorised service centre will repair or replace, at its option, any defective part or component of which notice has been given during the warranty period. A warranty registration card must be filled out properly and be on file with the MOBA Australia service department before warranty repair or replacement can be approved. If service in the field is necessary to repair machine-mounted equipment under warranty, MOBA Australia may authorize on-site repairs at no charge for parts and labour. Travel time, accommodation and other expenses incurred to and from the place where repairs are made will be charged to the purchaser at the prevailing rates. If warranty service can be done at a factory authorised service centre, the customer will pay only one way freight charges.

Any evidence of negligence or abnormal use, accident or an attempt to repair equipment by other than factory authorised personnel even when using MOBA Australia's certified or recommended parts, automatically voids the warranty.

The foregoing states the entire liability of MOBA Australia regarding the purchase and use of its equipment. MOBA Australia will not be held responsible for any consequential loss or damage of any kind.

This warranty is in lieu of all other warranties, except as set forth above, including any implied warranty of merchantability or fitness for a particular purpose, are hereby disclaimed. This warranty is in lieu of all other warranties, expressed or implied.



TABLE OF CONTENTS

1. Product Overview	7
2. Operating Elements	8
2.1. Graphic Display	8
2.2. Key Functions	8
2.3. Key Legend	9
2.4. LED Indication	10
2.5. Sensor Lights	10
2.6. Configuration Menu	11
3. First Steps	12
3.1. Basic Setup	12
3.2. Cable Connections	13
3.3. Connecting DUO ²	13
3.4. Hydraulic Valve Configuration	14
3.5. Powering Up	19
3.6. Working Screen	20
3.7. Setting Up Hydraulics	20
3.7.1. Selecting Type of Hydraulics	21
3.7.2. Adjusting Settings for Hydraulic Response	22
3.7.2.1 General Settings for VO Hydraulics	23
3.7.2.2 General Settings for IO Hydraulics	24
3.7.2.3 General Settings for ON/OFF Hydraulics	25
3.7.3. Calibration - Hydraulics	26
3.7.3.1 Min Pulse Calibration (Hydraulics)	26
3.7.3.2 Max Pulse Calibration (Hydraulics)	27
3.7.4. Advanced Settings - Hydraulics	28
4. Working with Panel	29
4.1. Manually Moving the Blade	29
4.2. Setting the Valve Control Mode	29
4.3. Grade to zero operation	30



TABLE OF CONTENTS (continued)

4.4. Reference, Offset & Set Target	31
4.4.1. To Select Reference	31
4.4.2. To Adjust Reference/Offset	31
4.4.3. To Transfer Current Sensor value into Reference/Offset	32
4.4.4. To Zero Reference/Offset value	32
4.5. Auxiliary Control	33
5. Sensor Settings	34
5.1. General Settings	35
5.1.1. Response	35
5.1.2. Dead Band	35
5.1.2.1 Setting Dead Band	36
5.1.3. Proportional Range Adjustment	37
5.1.4. Control Range Adjustment	37
5.1.5. Measurement Mode	38
5.1.6. Offset	38
5.1.7. Units	38
5.2. Calibrating Slope & Tracer Sensors	39
5.2.1 Before Calibrating Slope Sensor	39
5.2.2 Before Calibrating Tracer Sensor	40
5.3. LCD/LED Settings	42
5.4. Mast Mode of Operation	45
5.4.1. Mast Working Screen	45
5.4.2. Mast Function Keys	45
5.4.3. Adjusting Mast Position	46
5.4.4. Relative Offset	47

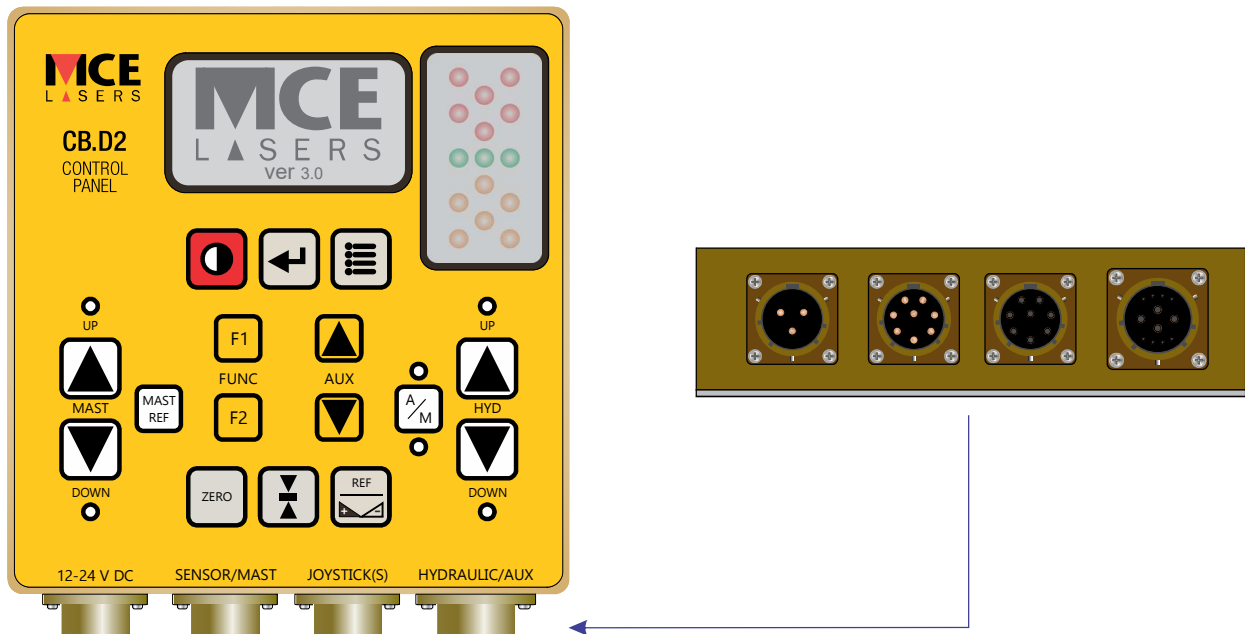

TABLE OF CONTENTS (continued)

5.5 GNSS Mode of Operation	50
5.5.1. GNSS Working Screen	50
5.5.2. GNSS Function Keys	50
5.5.3. GNSS Job Type Selection & Setup	51
5.6. Reset to System Default	52
6. Joystick Type (Optional)	53
7. HP Load Sensor (Optional)	56
7.1 Switching HP Load Feature On	57
8. Practical Example	61



1. PRODUCT OVERVIEW



The CB.D2 is a control panel for single machine control application. The CB.D2 has a single control for valve actuation and dual control for auxiliary valves. The system provides the user with the flexibility to independently use single or multiple valve control.

Information provided by the sensor is intelligently processed and applied to the valve control. System control status and sensor readings are shown in bigger fonts for easy viewing.

A clearly structured configuration menu enables the operator to set all necessary settings, from accuracy selection for control to the selection of different valve types to be used.

In addition a three-coloured 5 channel LED clusters of the unit provides an easily visible indication of the direction the hydraulic valves should be actuated to bring the blade to the set position.

The hydraulic valves can be actuated either automatically or manually, from the panel using keys or a joystick. The CB.D2 can drive ON/OFF hydraulic valves along with PV and PI without the need of any external accessory.



2. OPERATING ELEMENTS

2.1 GRAPHIC DISPLAY

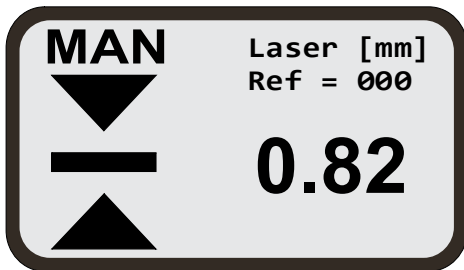

The graphic display (LCD) indicates the panel status, sensor reading and sensor dead band accuracy setting. Menus, parameters, important information and various settings are displayed when menus are accessed.

2.2 KEY FUNCTIONS

Power Key - turns the unit ON/OFF

Enter Key - use to accept settings or change settings while in the menu

Menu Key - use to access the configuration menu

Aux Hyd Up and Down Keys -

to scroll through menu options, to increase or decrease the value of a setting, or to move AUX1 and AUX2 when connected

figure 3

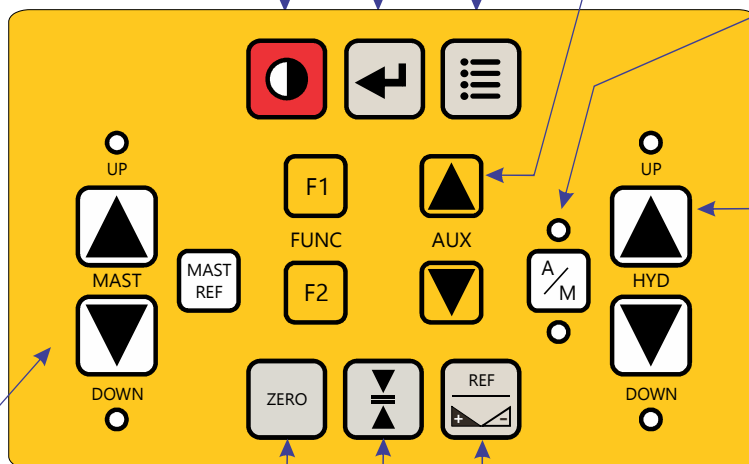

A/M Key - changes the hydraulics valve control between two operating modes: **manual mode** or **automatic mode**

Hyd Up and Down Keys - use to manually move hydraulics in up or down direction

Dead Band - adjust the sensor accuracy (Deadband)

Hydraulics left/right Key - reverses the sign of offset

Grade to Zero Key - set the value of the connected sensor or mast to zero (not available for all sensor types)















Mast Key - to move the mast up and down



2.3 KEY LEGEND:





This manual uses key designator for each graphical key representation. Please refer to this section for graphical key equivalent of each key designator.

CONTROL PANEL

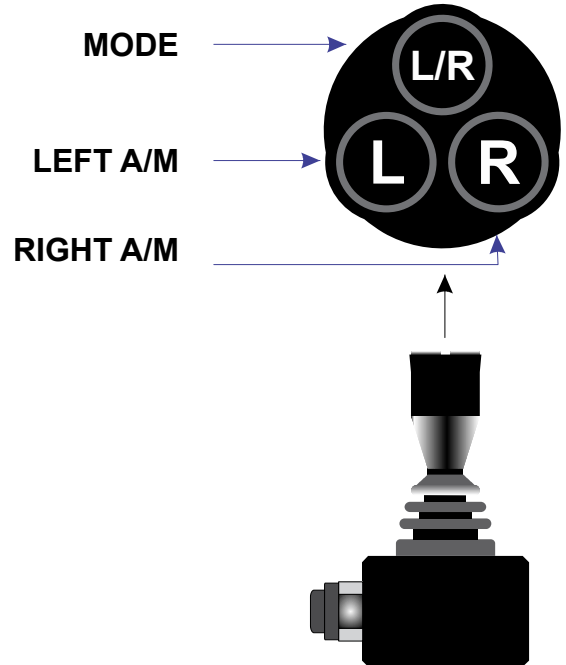
-  = [POWER] key
-  = [MENU] key
-  = [ENTER] key
-  = [ZERO] key
-  = [MAST] key
-  = [REF] key
-  = [A/M] key
-  = [AUX] key
-  = [AUX] key
-  = [FUNC] key
-  = [FUNC] key
-  = [HYD] key
-  = [HYD] key
-  = [HYD] key
-  = [HYD] key

MINI JOYSTICK



-  = [L/R] button
-  = [LEFT A/M] button
-  = [RIGHT A/M] button
-  = [MAST] key
-  = [MAST] key

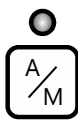

2.4 LED INDICATION

AUTO LEDS: ON when hydraulic control for the side is in automatic mode.
MANUAL LEDS: ON when hydraulic control for the side is in manual mode.



UP/DOWN LEDS: ON when the hydraulic valve is activated up or down.



UP/DOWN LEDS: ON when the Mast is activated up or down.

2.5 SENSOR LIGHTS

The sensor lights indicate the magnitude of the deviations from the centre or on target and the required direction of the valve actuation to return to centre or on target. The meaning of the different sensor light indications are shown below.

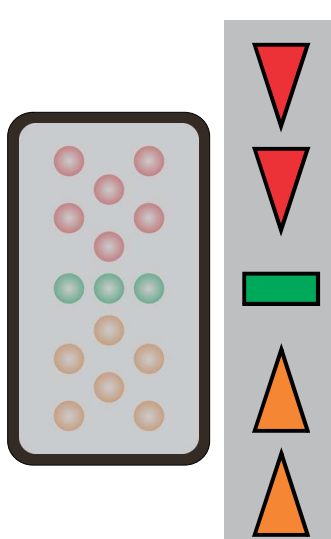
	Top red arrows blinking = very large upward deviation. Need to lower the bucket/blade by a lot.
	Both red arrows blinking = large upward deviation. Need to lower the bucket/blade.
	Only inner red arrow blinking = small upward deviation. Need to lower the bucket/blade by a little.
	Inner red arrow and green bar blinking = very small upward deviation. Need to lower the bucket/blade by very little.
	Green bar blinking = no deviation (centre or on target).
	Inner orange arrow and green bar blinking = very small downward deviation. Need to raise the bucket/blade by very little.
	Inner orange arrow blinking = small downward deviation. Need to raise the bucket/blade by a little.
	Both orange arrows blinking = large downward deviation. Need to raise the bucket/blade.

Bottom orange arrows blinking = very large downward deviation. Need to raise the bucket/blade by a lot.



Memory mode: If only top red or bottom orange arrows are blinking at slow rate it indicates the last direction of required correction before the laser beam went off the sensor receiving area.

No communication: If both top red and bottom orange arrows blink together it indicates that the panel has lost communication with the sensor. Please check the cable connection at this point.

LOW BATTERY WARNING

If the battery voltage drops below the level required for operation of the unit, a low battery symbol will appear on the LCD briefly before the unit is automatically shutdown.

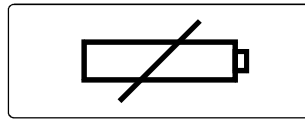

2.6 CONFIGURATION MENU

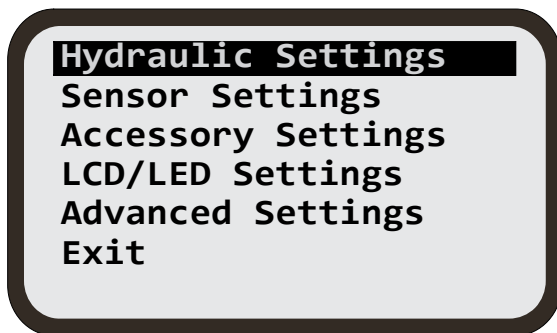

A variety of settings and features can be set or adjusted through the CB.D2 configuration menu.

Settings include simple things like brightness of the panel LEDs to more advance settings like configuration of different hydraulic valve types.

From the working screen press the [MENU] key to bring the configuration main menu screen.

Using [AUX] key scroll down to select a submenu then press the [ENTER] key.



3. FIRST STEPS

This chapter will provide you with information on getting started, connections and setting up. In addition, a description of the symbols and displays used in the working window will be explained.

3.1 BASIC SETUP

The CB.D2 control panel can be setup in multiple different configurations as illustrated below.

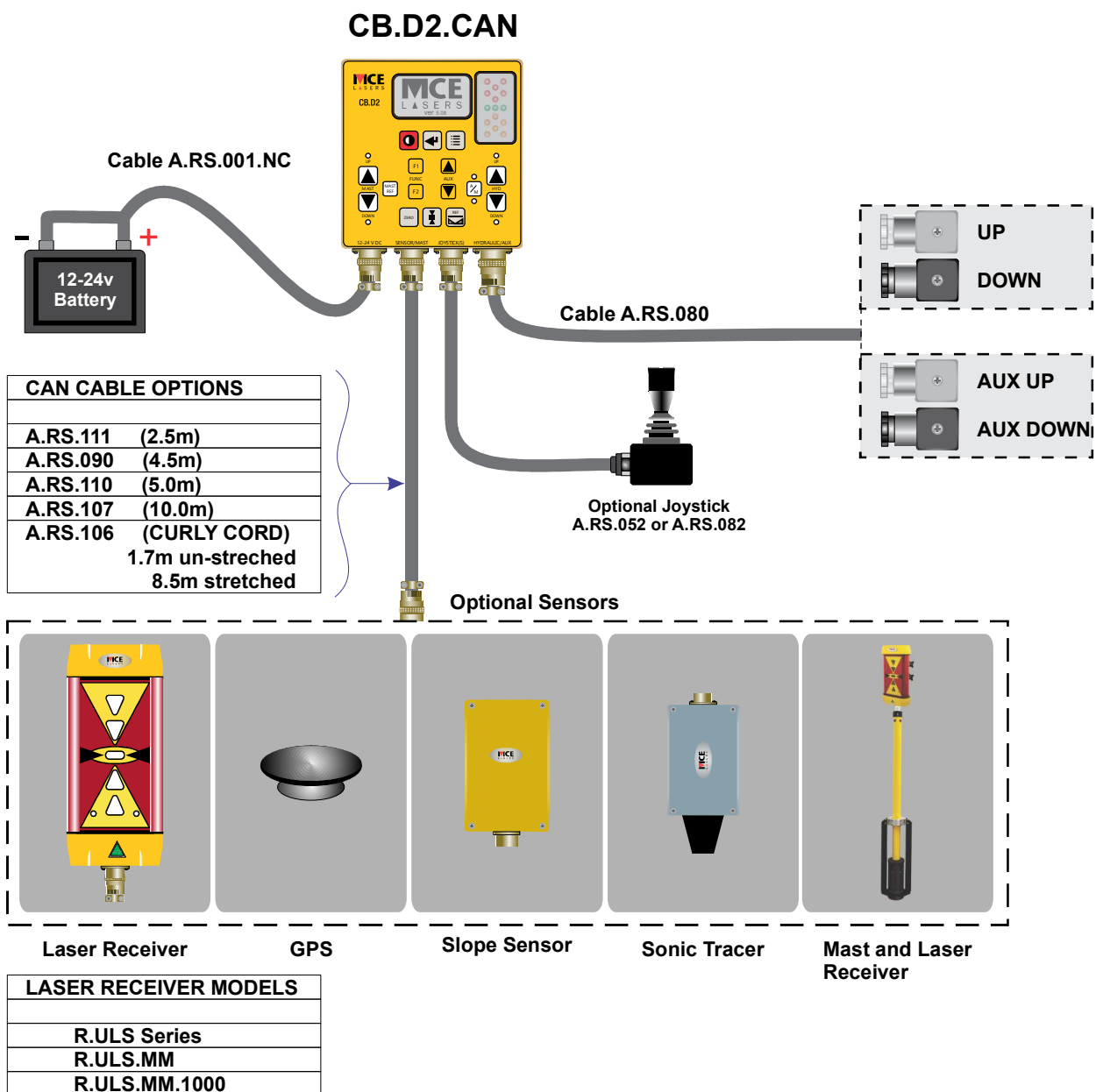



3.2 CABLE CONNECTIONS

For connecting power, sensors, valves and joystick only use the cables provided with the CB.D2 system. The cable connections with part number for cable is as below:

	Option 1 (RS232 Comm)	Option 2 (CAN Comm)
Connection	Cable Number	Cable Number
CB.D2 - Power	A.RS.001 or A.R.S.001.NC	A.RS.001 or A.RS.001.NC
CB.D2 - Sensor	A.RS.074 or A.R.S.034	Straight and Curly CAN Cord Options
CB.D2 - Hydraulic valves	A.RS.080	A.RS.080
CB.D2 - Joystick/Remote	No cable required, connect joystick directly	No cable required, connect joystick directly

3.3 CONNECTING THE CB.D2

1. Mount the CB.D2 panel somewhere easily accessible by the operator and secure it properly.
2. Mount the sensor on post or bracket mounted on the blade or bucket and connect it to the junction box using appropriate cable.
3. Connect the joystick (optional) to the 'JOYSTICK' connector on the CB.D2.
4. Connect 12-24v DC (machine battery) to the connector labelled 12-24v on CB.D2 using appropriate cable.
5. Connect the hydraulic valves to the connector labelled 'HYDRAULIC/AUX' on the CB.D2 using A.RS.080 cable. The end of the cable with the bare wires should be connected to the valves as explained in the following section. Note that the hydraulic valves are normally part of the machine and are not supplied by the MOBA Australia.



3.4 HYDRAULIC VALVES CONFIGURATION

The CB.D2.CAN can manually and automatically drive most of the commercially available solenoid valves, including popular brands such as Danfoss, Eaton-Vickers, Rexroth and others. It has four different types of hydraulic output drive signal available, suitable for different types of valves as explained in the table below.

Hydraulic Output Type	Output Drive	Example Solenoid Valves That Can Be Driven	Menu Selection	Description
Voltage Proportional	Voltage Signal	Danfoss PVG series with PVE actuator	V[0]	This output is a low current voltage signal, not intended to drive a solenoid directly. Mainly used with Danfoss Proportional Valves which have the PVE actuator incorporated, but other valves with similar actuator can also be driven. Valve spool stroke is proportional to the voltage signal.
Current Proportional	Current	1) Eaton-Vickers KDG4V series 2) Rexroth 4WRAB6	I[0]	This current output can be up to 3A and can directly drive a solenoid. Valve spool stroke is proportional to the current amplitude.
ON/OFF Low Side	Current	1) Eaton-Vickers KDG4V series 2) Rexroth 4WRAB6	ON/OFF (Low Side)	This current output can be up to 3A and can directly drive a solenoid. The 'Low Side' refers to the activation method which is done by switching ground. Valve spool stroke is either maximum (solenoid active) or neutral (solenoid inactive).
ON/OFF High Side	Current	1) Danfoss ON/OFF with PVEO actuator 2) Eaton-Vickers KDG4V series 3) Rexroth 4WRAB6	ON/OFF (High Side)	This current output can be up to 3A and can directly drive a solenoid. The 'High Side' refers to the activation method which is done by switching the positive voltage supply. Valve spool stroke is either maximum (solenoid active) or neutral (solenoid inactive).

Table 1: Hydraulic Output Types



The CB.D2.CAN is normally supplied with hydraulic cable A.RS.080 which has colour-coded and labelled bare wires on one end allowing the user to connect their valve according to the particular hydraulic output type requirement for that valve.

Below are examples of how to connect the bare wires for each of the four hydraulic output types using as examples some common valve brands and assuming Hirschmann type connector (CETOP valves). The table can be used as a guide for connecting other valve brands and models, once their hydraulic output requirement and pinout is known.



Hydraulic Output Type	Example Valves	Valve Pin Layout*	Connections of A.RS.080 Bare Wires (Wire Colour - Wire Label)
Voltage Proportional (V[O])	Danfoss PVG series with PVE actuator		PIN 1: Grey – VCC PIN 2: Yellow – SIG1/UP1 PIN 3: Not Connected GND: Pink - GND
Current Proportional (I[O]) or On/Off Low Side	1) Eaton-Vickers KDG4V series (Current Proportional output) 2) Rexroth 4WE6 (On/Off Low Side output) 3) Eaton-Vickers DG4V series (On/Off Low Side output). <i>Note: The Rexroth 4WE6 and Eaton-Vickers DG4V can also be driven with On/Off High Side output if wired as shown in On/Off High Side below</i>	Up Coil 	PIN 1: Grey – VCC PIN 2: Yellow – SIG1/UP1 GND: Pink - GND(Optional)
		Down Coil 	PIN 1: Green – VCC PIN 2: Orange – DOWN1 GND: Not Connected
On/Off High Side	1) Danfoss On/Off with PVEO actuator 2) Rexroth 4WE6 series 3) Eaton - Vickers DG4V series <i>Note: The Rexroth 4WE6 and Eaton - Vickers DG4V can also be driven with On/Off Low Side output if wired as shown in On/Off Side row above.</i>		PIN 1: Orange – DOWN1 PIN 2: Yellow – SIG1/UP1 PIN 3: Not Connected GND – Pink - GND
		Up Coil 	PIN 1: Pink – GND PIN 2: Yellow – SIG1/UP1 GND - Pink-GND(Optional)
	Down Coil 	PIN 1: Pink – GND PIN 2: Orange – DOWN1 GND: Not Connected	

Table 2: Typical Hydraulic Cable Connections

* In cases where valve pins are not numbered, use the position of the straight pin relative to the other pins as shown in the pin layout to determine which pin is which.



The CB.D2.CAN can optionally drive an additional On/Off type valve which can be used for auxiliary functions such as, for example, moving a wheel up and down on a skid steer machine. This hydraulic output can normally only be activated manually using the Aux Up and Down buttons. In special cases, when selected through the Advanced Settings in the menu, the Aux Up can be activated automatically whenever the main hydraulic output (up or down) is activated.

Below is how to connect this valve using the bare wires of the A.RS.080 cable, assuming CETOP type valve (Hirschmann connector).

Valve Pin Layout	Connections of A.RS.080 Bare Wires (Wire colour- Wire Label)
Up Coil 	PIN 1: White - AUX1/ UP PIN 2: Pink – GND PIN 3: Not Connected
Down Coil 	PIN 1: Black - AUX1/DOWN PIN 2: Pink – GND PIN 3: Not Connected

Table 3: Typical Auxiliary Hydraulic Connections



The drawing below shows how the A.RS.080 cable would be wired for a Current Proportional or On/Off Low Side output with optional Auxiliary using Hirschmann connectors.

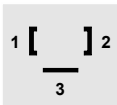
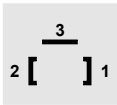
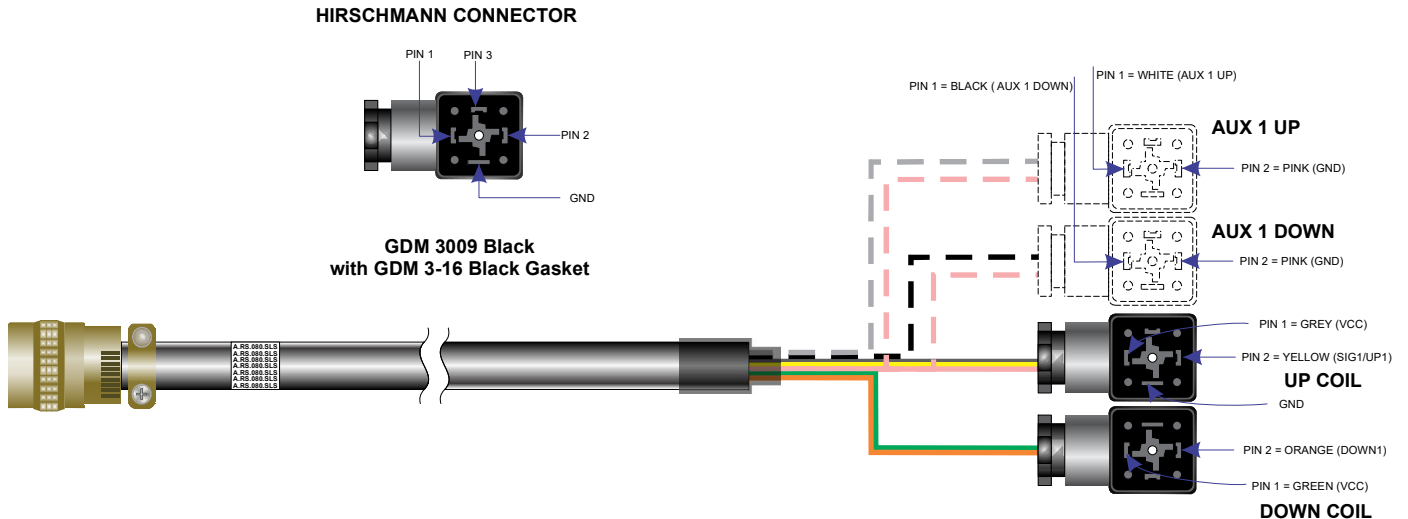

Upon request, the A.RS.080, can be factory wired with Hirschmann connectors by MOBA to save the user from having to do it themselves. To do this, the valve model and specifications should be provided to MOBA so that the correct connection type can be determined.

In cases where the machine solenoid valves are accessible only by directly plugging into an in-cab dashboard connector, such as for example in CNH 'Case' and 'New Holland' machines, the A.RS.080 can be factory wired with a Deutsch type or other suitable connector for direct plug in.

See section 3.7.1 for how to select one of the hydraulic output types through the menu.



3.5 POWERING UP

Before powering up the CB.D2 for the first time, a visual inspection is recommended to confirm everything is connected correctly and is well secured (refer top sections 3.1 - 3.4).

Check and confirm especially that the type of hydraulic valves has been correctly determined and the wiring has been done as per section 3.4 for the particular type of valve. Check all system components for obvious damage, all cable connections for securely fitted connections and the sensor for secure and accurate mounting. When starting up the CB.D2 ensure that no person or objects are located within range of the moving parts of the machine.

Press the [POWER] key to turn the unit on.

The CB.D2 system will go through initialisation sequence and the working screen will come up.



3.6 WORKING SCREEN

Information and settings related to individual function are shown. See the typical example of working screen when a laser beam is hitting the laser receiver that is connected to the panel.

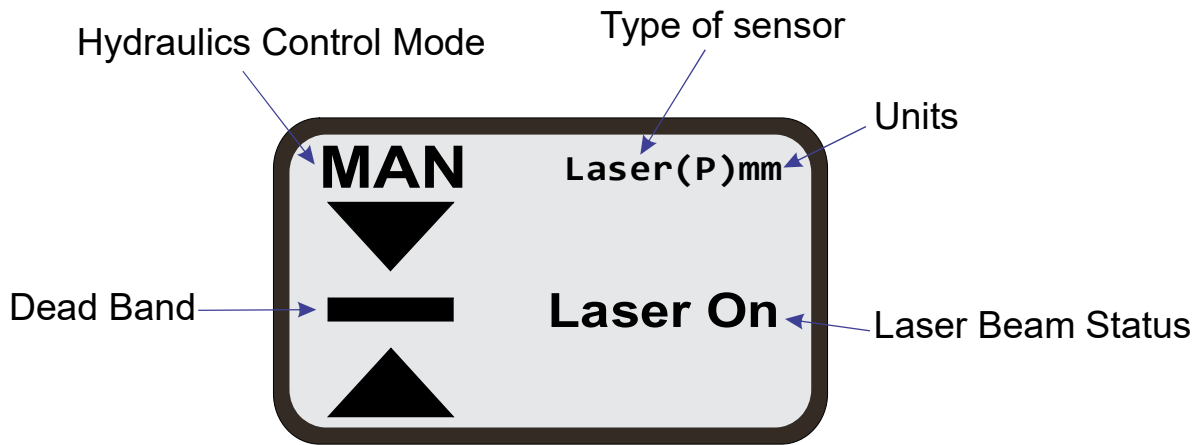

3.7 SETTING UP THE HYDRAULICS

Hydraulic Settings

- Sensor Settings
- Accessory Settings
- LCD/LED Settings
- Advanced Settings
- Exit

As the CB.D2 supports multiple types of hydraulic valves, it is very important to firstly select the correct type of valve operating on the machine.

From the Working screen, press the [MENU] key to bring the configuration menu.

With 'Hydraulic Settings' highlighted, press the [ENTER] key to access Hydraulic settings submenu.

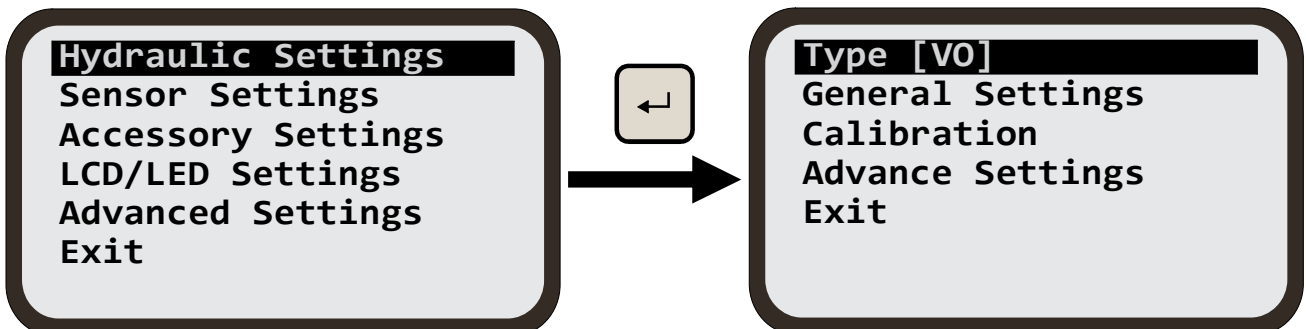



3.7.1 SELECTING TYPE OF HYDRAULICS

The currently selected hydraulic type is shown in []. Press the [ENTER] key to access 'Hydraulic Type' selection submenu.

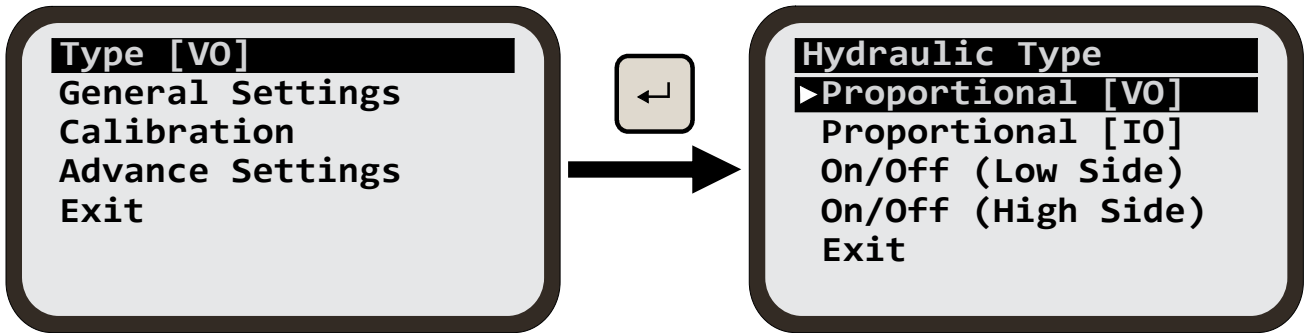

Using [AUX] key, select the type of hydraulic connected on the machine then press the [ENTER] key to set.

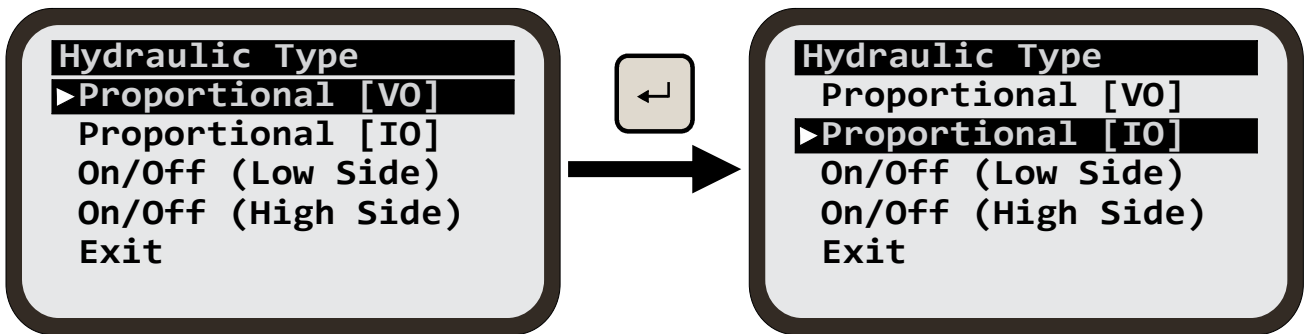

When finished, use [AUX] key to select 'Exit' and press [ENTER] key.

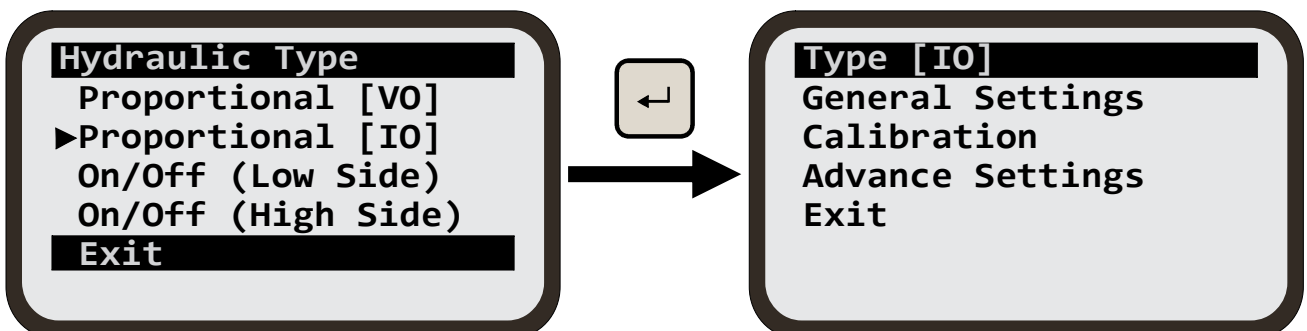

3.7.2 ADJUSTING SETTINGS FOR HYDRAULIC RESPONSE

Using [AUX] key, select 'General Settings' for hydraulics then press the [ENTER] key.

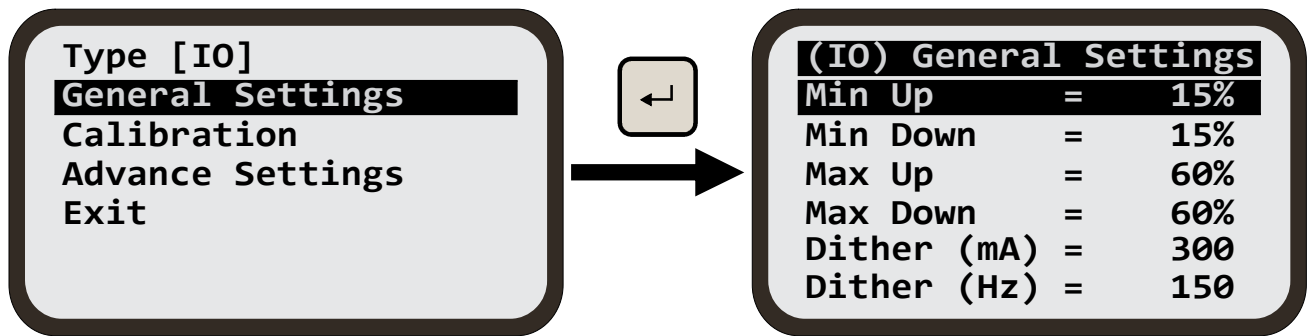

Different hydraulic types have different settings which control the behaviour of the hydraulic response during auto mode of operation. Select the hydraulic type as described in the previous section and then adjust the settings under 'General Settings' to optimise the hydraulic response .

To adjust these settings:

1. Use [AUX] key to select a setting and then press the [ENTER] key.
2. The setting will start to blink indicating editing mode. Use [AUX] key to adjust the value .
3. When finished adjusting, press the [ENTER] key again to exit editing mode.
4. To exit the submenu, use [AUX] key to select exit and then press [ENTER] key.

The overall hydraulic response depends on many factors that differ from user to user. These include hydraulic oil pressure, size of the blade or bucket being moved, valve brand, sensor connected to the CB.D2 and others. Because of this, there is not one set of correct settings to use. The following sections give an explanation of each of the settings to help the user optimise the overall hydraulic response.



3.7.2.1 GENERAL SETTINGS FOR VO HYDRAULICS

(VO) General Settings		
Min Up	=	15.0%
Min Down	=	15.0%
Max Up	=	60.0%
Max Down	=	60.0%
Direction	=	Normal
Exit		

1. Min up: Minimum signal that is applied to move the blade/bucket in upward direction. This signal is applied when the signal from the connected sensor is just on the 'ON TARGET' (green) band. If set too high, the bucket/blade will overshoot the target going up. If set too low, the blade or bucket may not move up at all when only small upward adjustment is required.

2. Min Down: Minimum signal applied to move blade/bucket in downward direction. This signal is applied when the signal from the connected sensor is just on the 'ON TARGET' (green) band. If set too high, the blade/bucket will overshoot the target going down. If set too low, the blade/bucket may not move up at all when only small downward adjustment is required.

3. MAX UP: Maximum signal that is applied to move blade/bucket in upward direction. This signal is applied when the signal from the connected sensor is below the 'ON TARGET' (green) band by an amount that is greater than or equal to the proportional range of the sensor. If set too high, the blade/bucket may move too fast and overshoots the target. If set too low, movement may be too slow.

4. MAX Down: Maximum signal that is applied to move blade/bucket in downward direction. This signal is applied when the signal from the connected sensor is below the 'ON TARGET' (green) band by an amount that is greater than or equal to the proportional range of the sensor. If set too high, the blade/bucket may move too fast and overshoots the target. If set too low, movement may be too slow.

5. Direction: Normal or Reverse direction of blade/bucket movement. If Reverse direction is selected, the CB.D2 will activate 'Down Hydraulics' when up signal is applied and will activate 'UP Hydraulics' when down signal is applied.



3.7.2.2 GENERAL SETTINGS FOR IO HYDRAULICS

(IO) General Settings		
Min Up	=	15%
Min Down	=	15%
Max Up	=	60%
Max Down	=	60%
Dither (mA)	=	300
Dither (Hz)	=	150

1. Min up: Minimum signal that is applied to move the blade/bucket in upward direction. This signal is applied when the signal from the connected sensor is just on the 'ON TARGET' (green) band. If set too high, the bucket/blade will overshoot the target going up. If set too low, the blade or bucket may not move up at all when only small upward adjustment is required.

2. Min Down: Minimum signal applied to move blade/bucket in downward direction. This signal is applied when the signal from the connected sensor is just on the 'ON TARGET' (green) band. If set too high, the blade/bucket will overshoot the target going down. If set too low, the blade/bucket may not move up at all when only small downward adjustment is required.

3. MAX UP: Maximum signal that is applied to move blade/bucket in upward direction. This signal is applied when the signal from the connected sensor is below the 'ON TARGET' (green) band by an amount that is greater than or equal to the proportional range of the sensor. If set too high, the blade/bucket may move too fast and overshoots the target. If set too low, movement may be too slow.

4. MAX Down: Maximum signal that is applied to move blade/bucket in downward direction. This signal is applied when the signal from the connected sensor is below the 'ON TARGET' (green) band by an amount that is greater than or equal to the proportional range of the sensor. If set too high, the blade/bucket may move too fast and overshoots the target. If set too low, movement may be too slow.

5. Dither (Amp): adjusts the amplitude of the dither. This parameter should be set as per the recommendation given by the manufacturer of the hydraulic valve.

6. Dither (Hz): adjusts the frequency of the dither signal. Dither signal is superimposed with the control current for improvement of the response of the system. This parameter should be set as per the recommendation given by the manufacturer of the hydraulic valve.

7. Direction: Normal or Reverse direction of blade/bucket movement. If Reverse direction is selected, the CB.D2 will activate 'Down Hydraulics' when up signal is applied and will activate 'UP Hydraulics' when down signal is applied.



3.7.2.3 GENERAL SETTINGS FOR ON/OFF HYDRAULICS

The On/Off hydraulic output can be made to pulse or to be solid.

On/Off (Low) Settings	
F-Sampling	= 4.0hz
Min Pulse Up	= 50ms
Min Pulse Dn	= 50ms
Max Pulse Up	= 250ms
Max Pulse Dn	= 250ms
Max Up	= 100.0%

- F-Sampling:** frequency of the pulsing hydraulic signal. A higher number gives more rapid bursts of adjustment. A lower number gives slower bursts of adjustment.
- Min Pulse Up:** the duration of the up pulse when the signal from the sensor is just below the 'ON TARGET' (green) band. If set too low, the blade/bucket may not move at all when small adjustment is required. If set too high, the blade/bucket will overshoot the target.
- Min Pulse Down:** the duration of the down pulse when the signal from the sensor is just below the 'ON TARGET' (green) band. If set too low, the blade/bucket may not move at all when small adjustment is required. If set too high, the blade/bucket will overshoot the target.
- Max Pulse Up:** the duration of the up pulse when the signal from the sensor is below the 'ON TARGET' (green) band by an amount that is greater than or equal to the proportional range of the sensor. If set too high, the blade/bucket may move too fast and overshoots the target. If set too low, movement may be too slow.
- Max Pulse Down:** the duration of the up pulse when the signal from the sensor is above the 'ON TARGET' (green) band by an amount that is greater than or equal to the proportional range of the sensor. If set too high, the blade/bucket may move too fast and overshoots the target. If set too low, movement may be too slow.
- MAX Up:** Maximum signal current that is applied to move blade/bucket in upward direction.
- MAX Down:** Maximum signal current that is applied to move blade/bucket in downward direction.
- Direction:** Normal or Reverse direction of blade/bucket movement. If Reverse direction is selected, the CB.D2 will activate 'Down Hydraulics' when up signal is applied and will activate 'UP Hydraulics' when down signal is applied.

If solid (non-pulsing) hydraulic output is required, set Min Pulse Up, Min Pulse Dn, Max Pulse Up and Max Pulse Dn to be equal with a value of $1/\text{Sampling} \times 1000$. For example, if 'F-Sampling' is set to 4Hz, set all to $1/4 \times 1000 = 250\text{ms}$.



3.7.3 CALIBRATION (HYDRAULICS)

The Minimum and Maximum hydraulic signal settings can be determined by selecting the option in the hydraulics menu.

In Hydraulics menu, using [AUX] key select 'Calibration', then press [ENTER] key.

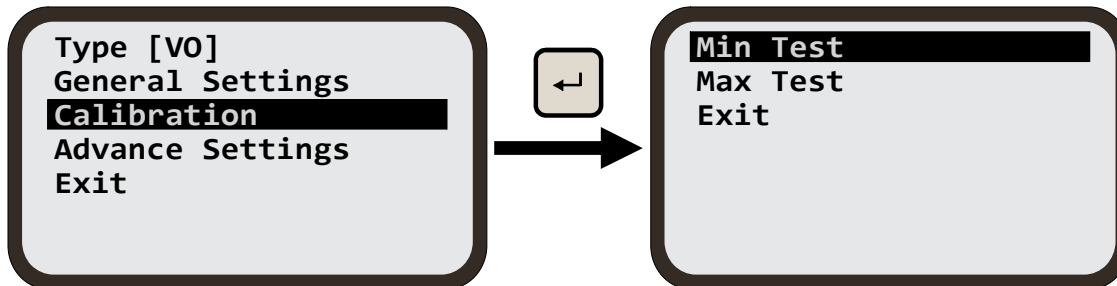

3.7.3.1 MIN PULSE CALIBRATION (HYDRAULICS)

The minimum settings required to move the blade/bucket up or down can be determined by selecting the 'Min Test' option.

In this test mode the system automatically applies an up and down pulse alternately, allowing the user to see in real time the effect on the blade movement with each change in value for minimum up and minimum down settings.

Press the [ENTER] key to begin the Min Pulse calibration.

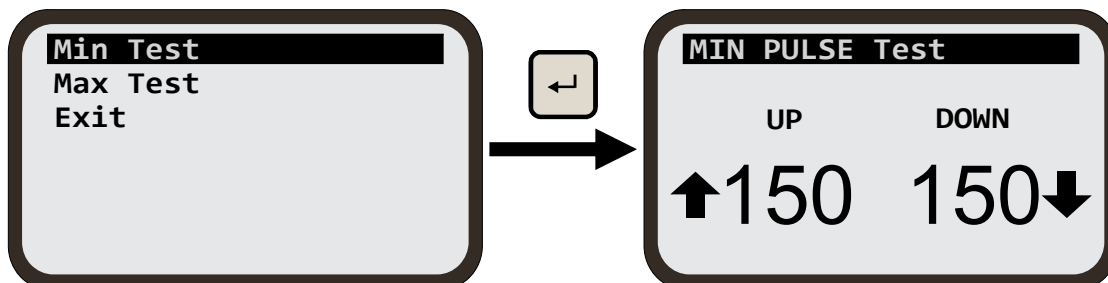

When doing Min Pulse Test, the aim is to find the minimum setting which will move the blade or bucket by the smallest amount in both upward and downward direction.

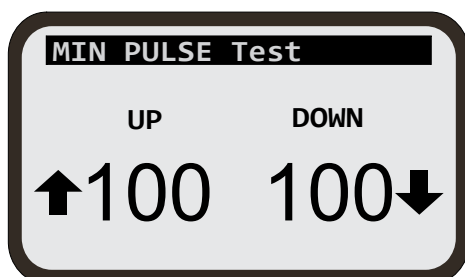

Use the [FUNC] key to adjust the value of minimum for up.

Use the [AUX] key to adjust the value of minimum for down.

Use the [MENU] key to return back to the calibration menu.



To determine the min settings:

1. Manually position the blade or bucket in the middle of the hydraulic cylinder working range.
2. Start with the minimum value of 100 for both up and down.
3. Slowly increase the value for Min Up. Stop when a small up movement is noticed on the blade/bucket.
4. Slowly increase the value for min pulse down, stop when a small movement is noticed in blade/bucket.
5. Carefully adjust the Min Up and Min Down around these value to achieve a symmetrical response.
6. When a symmetrical response is achieved, the blade/bucket will oscillate above and below a fixed spot during the test and should not drift gradually up or down.
7. When finished, press the [MENU] key to return back to the Calibration menu.

Note: During the test, the hydraulic cylinder may end up moving to the limit in one direction. Manually move the cylinder back in the middle of its working range before continuing with the test.

3.7.3.2 MAX PULSE CALIBRATION (HYDRAULICS)

The maximum settings required to move the blade or bucket up or down can be determined by selecting the 'Max Test' option. In this test mode the system automatically applies an up and down pulse alternately, allowing the user to see in real time the effect on blade/bucket movement with each change in value for maximum up and maximum down settings. When doing calibration for maximum signal, the up and down pulses are spaced by a large time interval than for minimum calibration.

In hydraulic's 'Calibration' menu, using [AUX] key, select the option MAX Test then press the [ENTER] key to begin the Max Pulse calibration.

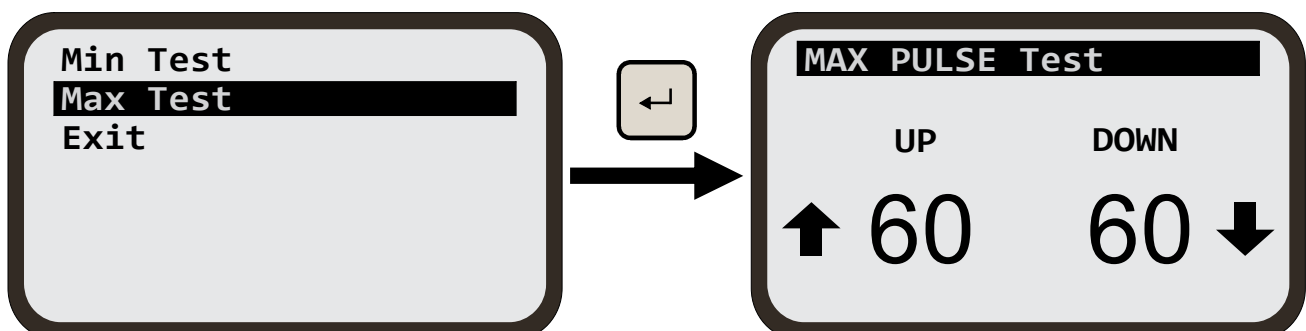



When doing the Max Pulse Test the aim is to find a setting which will move the blade/bucket at a satisfactory speed. Adjust the value for up and down to find the smallest acceptable value in both directions.

Use the [FUNC] key to adjust the value of Maximum for UP.

Use the [AUX] key to adjust the value of Maximum for DOWN.

To determine the optimum Max settings:

1. Manually position the blade/bucket in the middle of the hydraulic cylinder working range.
2. Start with maximum value of 100 for both up and down.
3. Slowly decrease the value for Max Up to find the minimum value giving satisfactory speed.
4. Slowly decrease the value for Max Down to achieve a symmetrical response.
5. When finished, press the [MENU] key to return back to the 'Calibration' menu then press the [MENU] key again to return to the working screen.

Note: During the test, the hydraulic cylinder may end up moving to the limit in one direction. Manually move the cylinder back in the middle of its working range before continuing with the test.

Usually more fine tuning of the Max and Min settings may be required after using Auto mode for the first time and observing dynamic behaviour in real working conditions. This can be done by adjusting the Min and Max settings through the menu without entering 'Calibration' mode.

3.7.4 ADVANCED SETTINGS (HYDRAULICS)

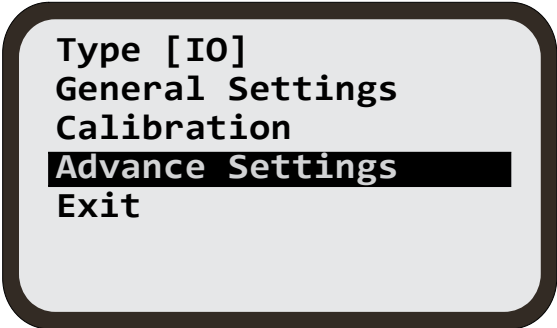

Type [IO]
General Settings
Calibration
Advance Settings
Exit

The Advanced settings for hydraulics can be used in special cases where hydraulic response remain unsatisfactory after careful adjustment of the General hydraulic settings. Currently, these settings are only available to MOBA Australia service technicians and distributors.



4. WORKING WITH PANEL

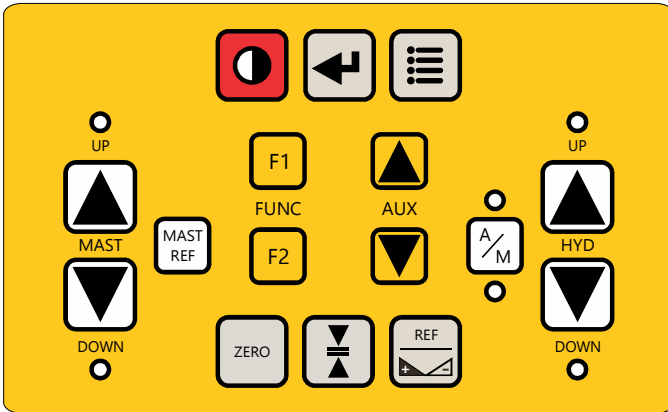

Please refer to section 2.2 for Key Functions.

4.1 MANUALLY MOVING THE BLADE OR MAST

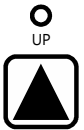

From the panel, the [HYD] UP key can be used to manually activate the valves to move the blade/bucket up.



Similarly, the [HYD] DOWN key can be used to manually activate the valves to move the blade/bucket down.



From the panel, the [MAST] UP key can be used to manually activate the motor to move the mast up.



Similarly, the [MAST] DOWN key can be used to manually activate the motor to move the mast down.



4.2 SETTING VALVE CONTROL MODE

From the panel, use the [A/M] key to switch between the two modes of control for the hydraulic valves.

MANUAL MODE

When the unit is in manual mode the LCD on the panel will show the image on the right.

When unit is in this mode, blade/bucket movement is only controlled by the user using the [HYD] UP or DOWN buttons, or by using the joystick if fitted.

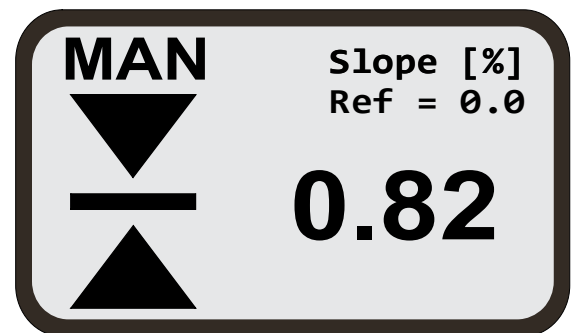



AUTO MODE

When the unit is in auto mode the LCD on the panel will show the image on the right.

In this mode, the panel automatically brings the blade/bucket to the centre position. The user can temporarily override automatic control at any time by pressing the [HYD] UP or DOWN buttons or by using the joystick if fitted. Automatic control returns upon release of the buttons or joystick handle.

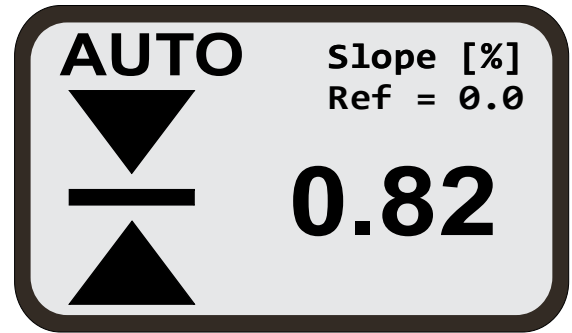

WARNING: Extreme care should be exercised when switching the CB.D2 to Auto for the first time in an unfamiliar setup. The mounting of the sensors might be such that, in attempting to achieve center, the blade/bucket forcefully digs into the ground; or the default hydraulic settings might cause the blade/bucket to oscillate and/or considerably overshoots the center position. The user should be on guard to immediately switch to Manual hydraulic control or switch the unit off.

4.3 GRADE TO ZERO

The current screen reading for certain models of laser sensor, for GPS sensor and for masts can be zeroed at any time.

From the working screen press the [ZERO] key to zero the sensor connected to CB.D2.

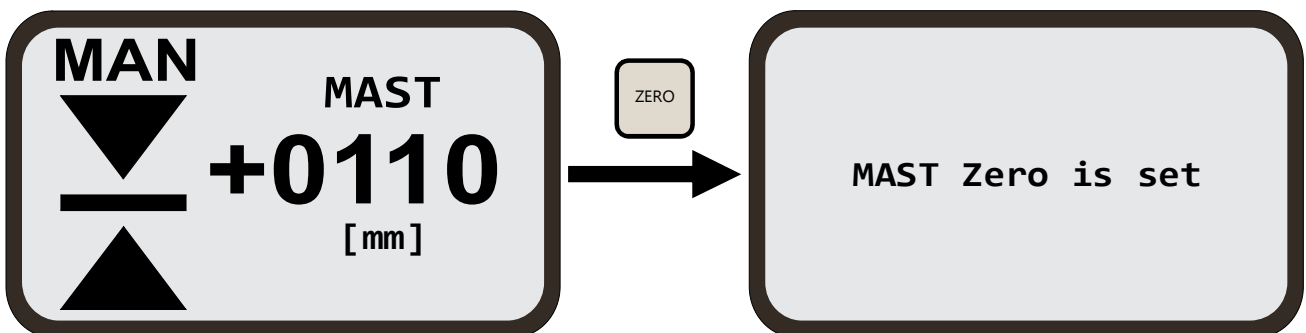

Note:

- 1.) Some sensor model do not support grade to zero.
- 2.) Grade to zero for laser sensors only works if the beam is hitting the sensor.

4.4 REFERENCE/SET TARGET/OFFSET

During normal operation, the currently used reference/offset target value is displayed in the second line of the screen for all sensor types.

This value is the desired offset of the blade/bucket from zero position.

Laser mm sensors, slope sensors and tracer sensors allow up to four reference/offset values. These values are adjustable through the reference menu. At any given time, only one of the four references/offsets can be selected as the current reference/offset for the sensor.

From the working screen press and hold the [REF] key to bring up the reference/offset side selection screen.

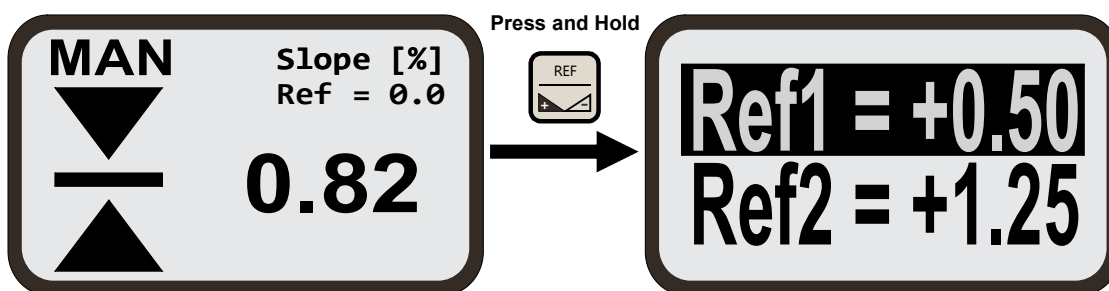

4.4.1 TO SELECT THE REFERENCE

From the Ref menu screen, use the [AUX] key to highlight the reference/offset, then press the [REF] key to select the reference/offset. The screen will return back to the working screen and the selected Ref will be shown on the second line of the screen.

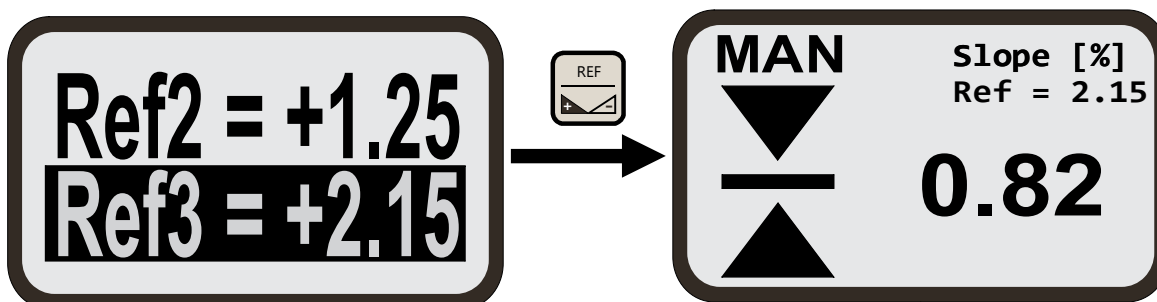

4.4.2 TO ADJUST REFERENCE/OFFSET

From the Ref menu screen, use the [AUX] key to highlight the reference/offset, then press the [ENTER] key.

The value will start to blink. Now use the [AUX] key to adjust the reference/offset value. Press [ENTER] key when finished adjusting.



4.4.3 TO TRANSFER CURRENT SENSOR VALUE INTO REFERENCE/OFFSET

From the working screen, press the [FUNC] key's Up and Down buttons together to set reference/offset value to be the same as the current sensor value.

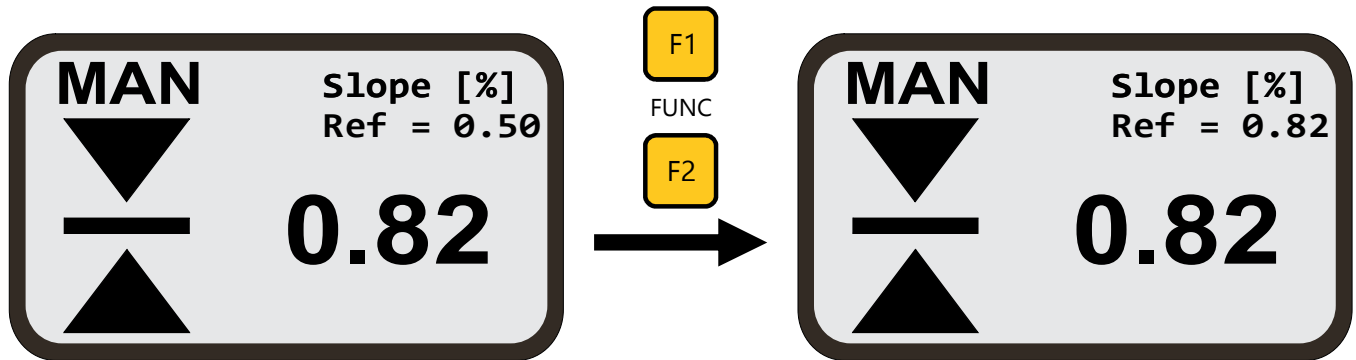

4.4.4 TO ZERO REFERENCE/OFFSET VALUE

Use the [AUX] key to highlight the reference, then press the [ENTER] key, to edit the Ref.

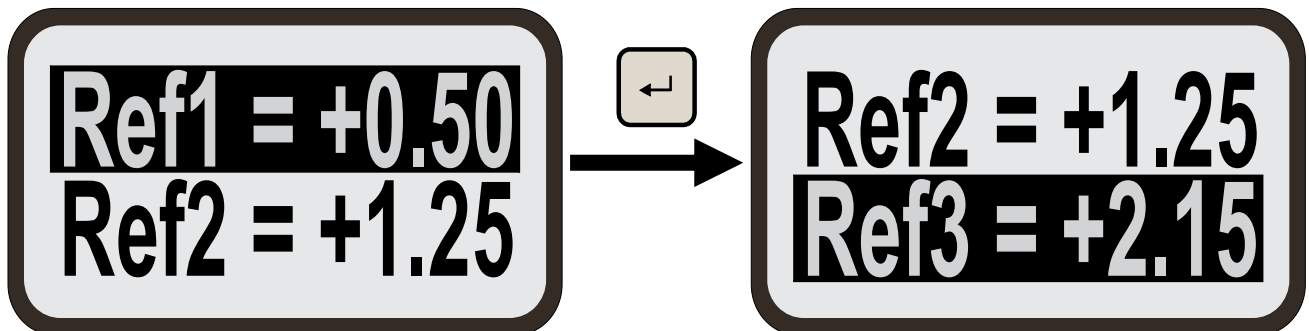

Press the [AUX] key's Up and Dn buttons together to zero the Ref value.

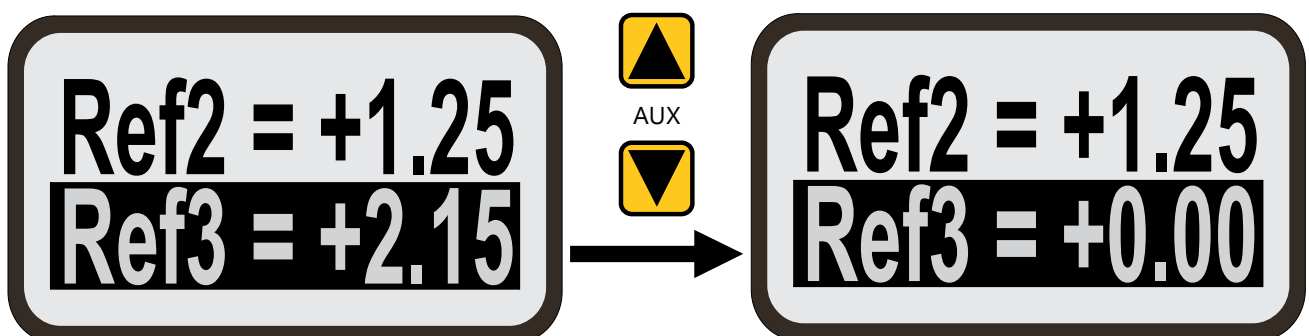

The currently selected Ref can also be adjusted from the Standard Screen without entering Ref menu. Simply press [FUNC] key's Up or Down button to adjust the value.

4.5 AUXILIARY CONTROL

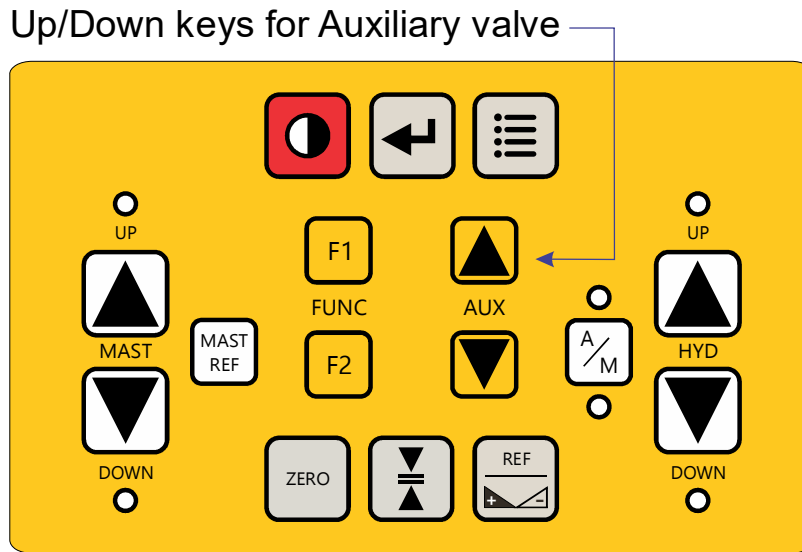

The CB.D2 has the ability to control auxiliary On/Off type valves which can be used for user defined applications such as smudge bar control. These can only be operated manually using the [AUX] up/down keys and only while not inside a menu or a sub-menu. To use these keys for Auxiliary valve activation, this function should be allocated to these keys through the menu.



5 SENSOR SETTINGS

Using [AUX] key scroll down to select the Sensor Settings and then press the [ENTER] key to bring the sensor setting. Based on the sensor connected the settings could differ.

SLOPE SENSOR SETTINGS

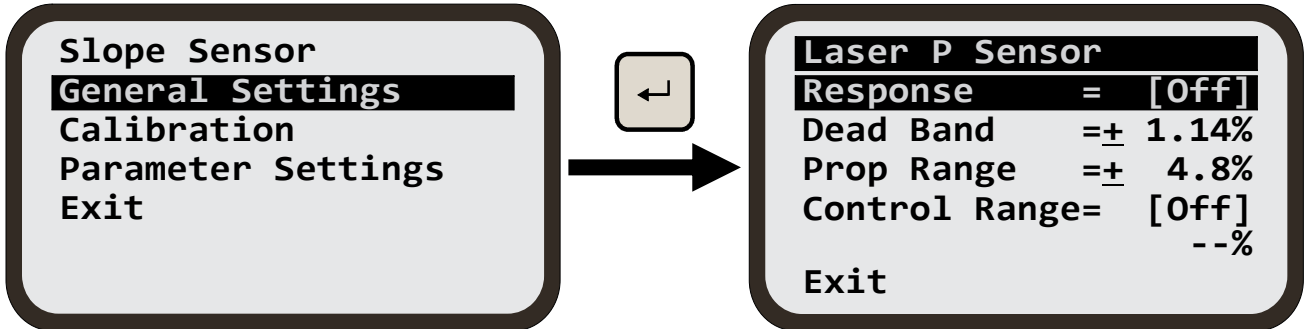

LASER SENSOR SETTINGS

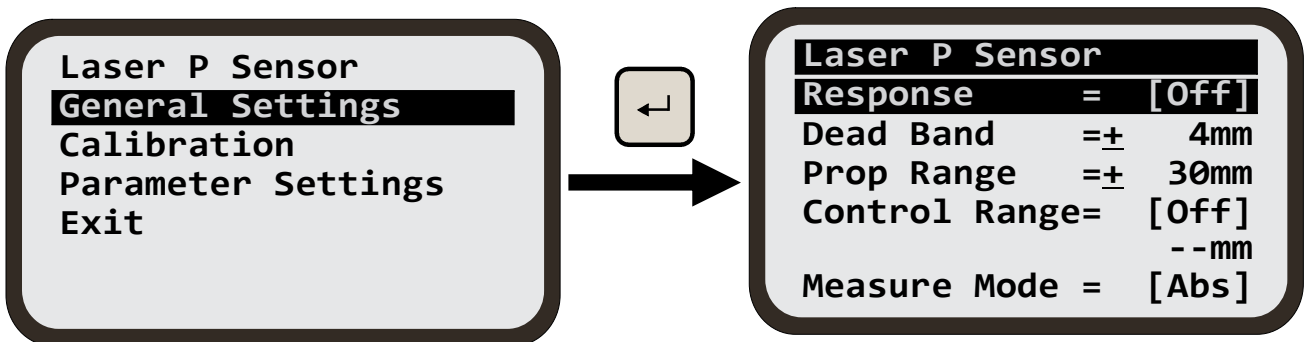

SONIC TRACER SENSOR SETTINGS

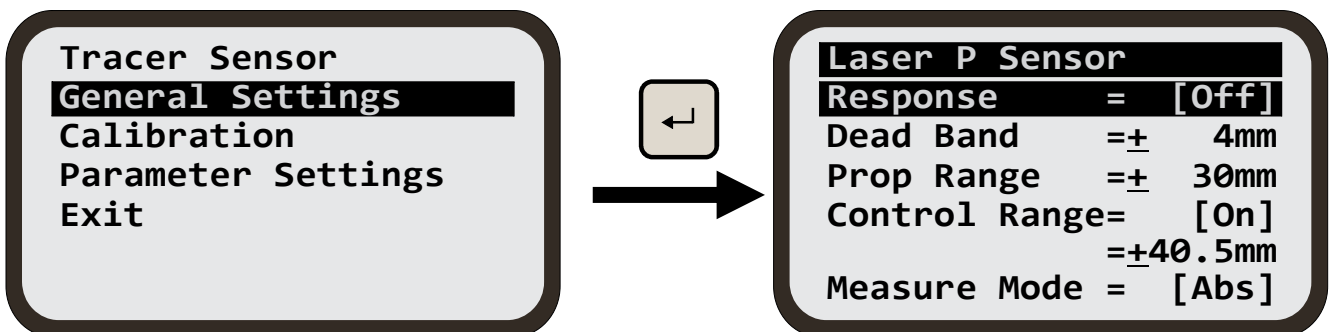



5.1 GENERAL SENSOR SETTINGS

5.1.1 RESPONSE

When enabled, response lets you select between 90 predefined setting combinations of deadband and proportional range which directly affect the overall response of the system.

Response of 1.0 applies the slowest and most accurate response possible

Response of 10.0 applies the fastest and least accurate response possible

5.1.2 DEAD BAND

This defines the accuracy of the system. The bigger the deadband, the less accurate the system is but the easier it is to achieve fast and stable hydraulic response. Conversely, the smaller the deadband the more accurate the system is but the harder it is to achieve fast and stable hydraulic response. The name deadband derives from the fact that once the sensor reading is within this band around the target (offset), it is considered 'ON TARGET' and stops (Kill off) hydraulic activation until the sensor reading goes outside this band again.

SENSOR TYPE	DEADBAND RANGE
Laser sensor	± 4 mm; ± 20 mm; ± 29 mm
Laser sensor	± 0.5 mm to ± 10 mm
Slope sensor	$\pm 0.2\%$ to $\pm 2.8\%$ mm
Sonic tracer sensor	± 2 mm to ± 10 mm
GPS sensor	

Note: deadband setting is not available when response is enabled.



5.1.2.1 SETTING DEAD BAND

From the working screen press the [MENU] key to bring up the settings menu.

Use the [AUX] key to select the 'Sensor Settings' menu. Select 'General Settings' then press [ENTER] key.

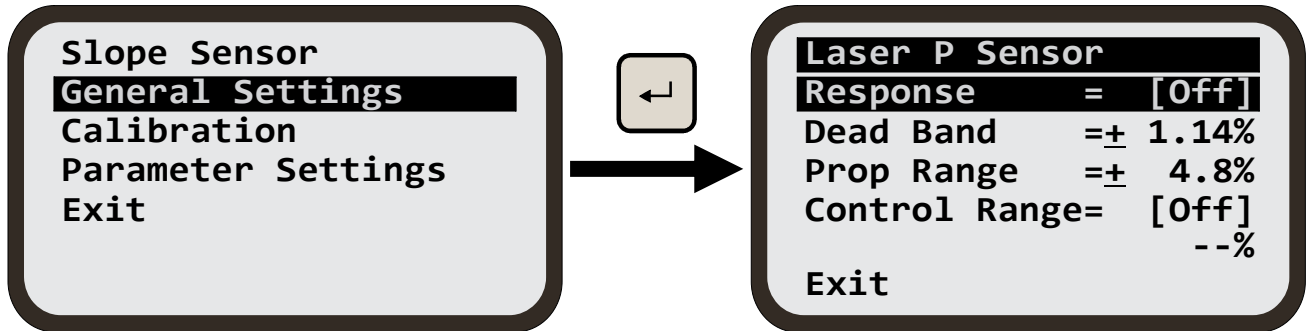

Select Dead Band then press [ENTER] key. The selection will blink. Use the [AUX] Up/Down button to set the desired value.

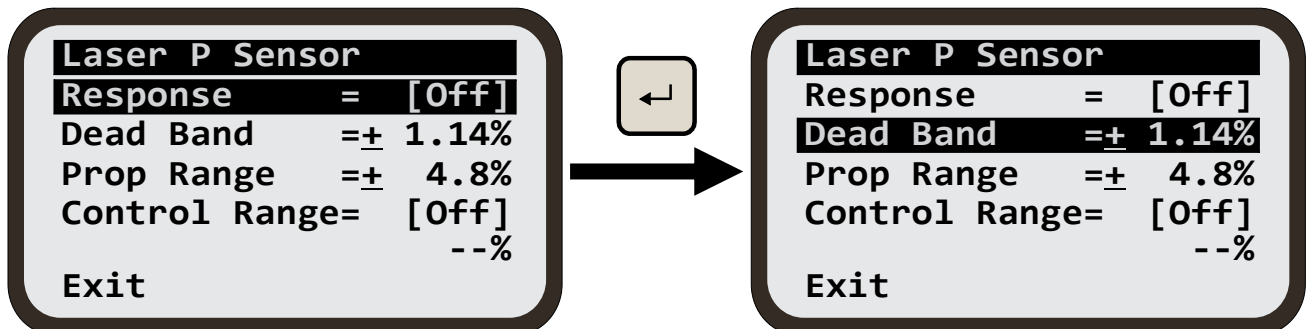



5.1.3 PROP RANGE (PROPORTIONAL RANGE)

The Proportional Range is the range of the sensor reading above and below the target over which the hydraulic output signal varies proportionally to the deviation of the sensor reading from the target.

The Min hydraulic output is applied when the sensor reading is just outside the Dead Band (beginning of the Proportional range). The Max hydraulic output is reached when the sensor reading deviates from the Target by an amount equal to or greater than the selected Proportional range. A smaller Proportional range means a faster hydraulic response.

SENSOR TYPE	SELECTABLE PROPORTIONAL RANGE
Laser Sensor - p	6 mm to 98 mm
Laser Sensor - mm	4 mm to 128 mm
Slope Sensor	3.1% to 30%
Trace Sensor	4 mm to 100 mm
GPS Sensor	

Note: proportional range setting is not available when response is enabled.

5.1.4 CTRL RANGE (CONTROL RANGE)

A selectable range above and below the Dead Band outside of which the automatic control of the valves is switched off .

SENSOR TYPE	SELECTABLE CONTROL RANGE
Laser sensor - P	3 mm to 98 mm
Laser sensor - mm	3 mm to 128 mm
Slope sensor	1% to 60%
Trace sensor	4 mm to 100 mm
GPS sensor	



5.1.5 MEASUREMENT MODE

The measurement mode for sensors with ability to zero the reading can switch between Relative [REL] and Absolute [ABS]. **Relative** mode means that the sensor reading is relative to the position where the zeroing occurred. **Absolute** mode means the sensor reading is taken from the factory default zero position. For example, for laser sensors, this is the physical centre of the receiving area. After executing a 'zeroing' using the zero button, the measure mode automatically becomes **Relative**. To revert back to **Absolute** mode, access sensor settings menu, select measure mode and press enter. ABS is then shown in the square brackets.

***Note:** On power down, the CB.D2 retains the previously used measurement mode. It is important before beginning a new job to ensure that the correct measurement mode is selected.*

5.1.6 OFFSET

When system is used in Relative Mode this reading shows the offset from absolute position.

5.1.7 UNITS

Select between various units of measurement for different sensor. Different units available for different sensors are

Slope Sensor :

1. Percentage [%]
2. Degrees [°]

Laser and Tracer Sensor :

1. Centimeter [cm]
2. Millimeter [mm]



5.2 CALIBRATING SLOPE & TRACER SENSORS

5.2.1 BEFORE CALIBRATING SLOPE SENSOR

Using the slope sensor for the first time or after remounting, it is important that it is mounted and calibrated correctly. The mounting should be robust enough to guarantee that the sensor will not move while the blade is being used. Preferably the sensor should not be removed once mounted so as to avoid having to repeat the calibration procedure. Ensure the following when mounting:

- 1.) The 'TOP' inscription on the sensor is on top.
- 2.) The long side of the sensor is parallel with the blade
- 3.) The reading on the screen of the sensor grade increases as the side the sensor is mounted on (or connected to) is raised and decreases as the same side is lowered. If not, turn the sensor 180°, ensuring steps 1-2 are still adhered to.
- 4.) The blade is physically level. This can be checked using a spirit level with a leveling sensitivity of +/- 0.01%.
- 5.) The sensor is approximately level with the blade.

Check should be done prior to beginning a new job to ensure that calibration is maintained. This involves physically leveling the blade using a spirit level with sensitivity +/- 0.01% and confirming that the reading of the sensor grade on the screen is approximately zero.



5.2.2 BEFORE CALIBRATING TRACER SENSOR

Tracer sensor is factory calibrated when supplied. However, the user is advised to check periodically that calibration is maintained.

To check and calibrate tracer sensor:

- 1.) Place a suitable target 350 mm away from the tip of the sensor, directly in front and ensure that both target and sensor are fixed in position.
- 2.) Use flat ground as the target and fix the sensor 350 mm above flat ground (from sensor tip to ground).
- 3.) Point the sensor tip directly down and ensure that there are no obstructions between sensor tip and target.
- 4.) Ensure that measurement mode is **Absolute**.
- 5.) Check that the sensor reading on the screen is approximately 350 mm.

The operating range of the tracer sensor is maximum 450 mm and minimum 250 mm and during normal grading operations, it is recommended that the sensor is at a distance from the tracked surface roughly midway between the maximum and minimum, ie, roughly 330 - 370 mm above the tracked surface. See section 7, 'Practical Example' for an example.



To execute calibration of the sensor, press [MENU] key from the working menu. Select 'Sensor Settings' then press [ENTER] key.

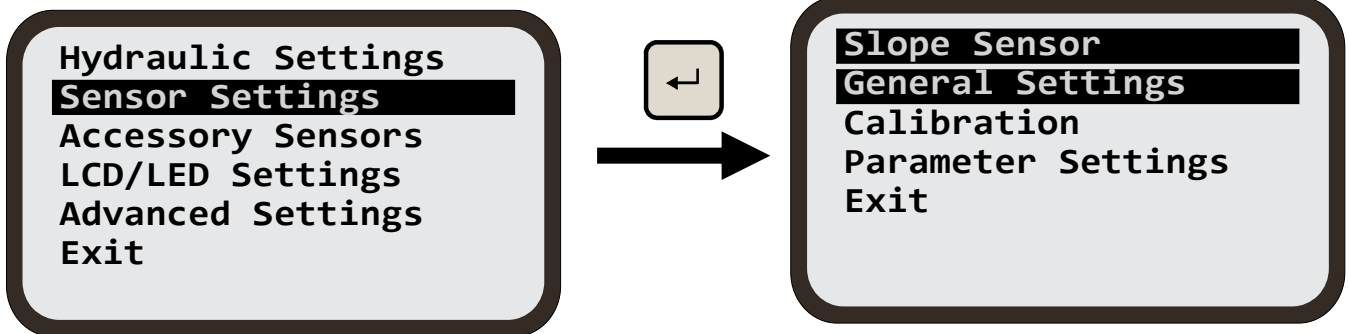

Select 'Calibration' then press [ENTER] key.

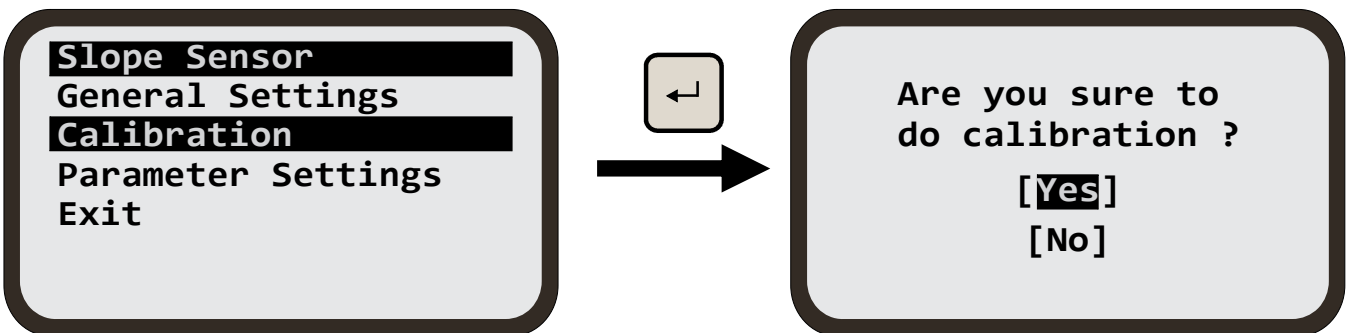

Simply select [YES] on the next window and hit [ENTER] key then "Calibration Done" will be displayed.

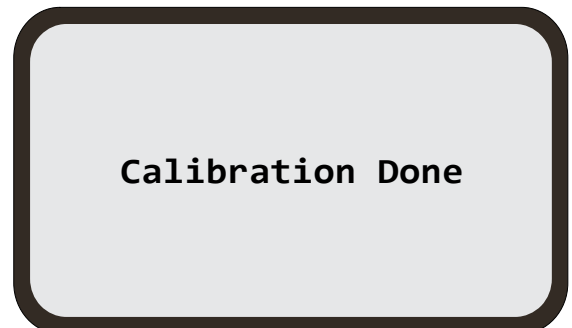

Note: Calibrating the Tracer sensor follows the same procedure as above.



5.3 LCD/LED SETTINGS

From the Main Menu screen use [AUX] key to scroll down to LCD/LED Settings then press the [ENTER] key to access the sub menu.

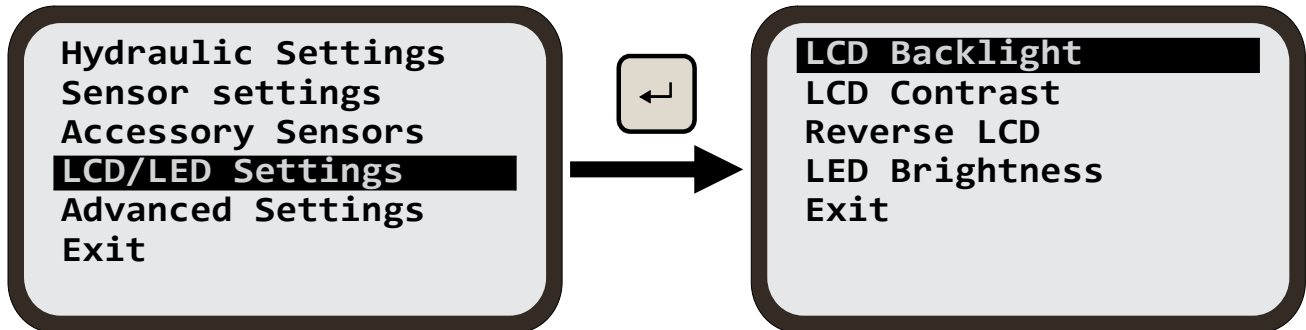

LCD BACKLIGHT SETTINGS

Press [ENTER] key to access the 'LCD Backlight' sub menu.

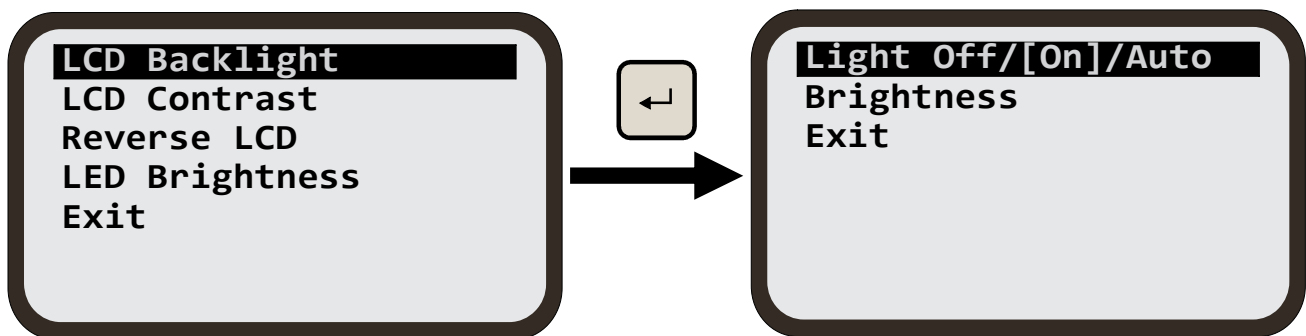

BACK LIGHT Off/[On]/Auto SETTING

With the Light 'Off/[On]/Auto' option highlighted press the [ENTER] key until the desired power option for Backlight is selected. The selected setting is shown in enclosed square brackets (e.g. [Auto]). The three settings work as below :

1. Off - If this option is selected the backlight will permanently stay off
2. On - If this option is selected the backlight will permanently stay On
3. Auto - If this option is selected the backlight will come on if a key is pressed and automatically switched off after 5 seconds of user inactivity.

Use the [AUX] key to select exit and press [ENTER] key to exit menu.



LCD BRIGHTNESS

Use [AUX] key to highlight the 'Brightness' setting then press the [ENTER] key to bring up the current brightness settings for LCD.

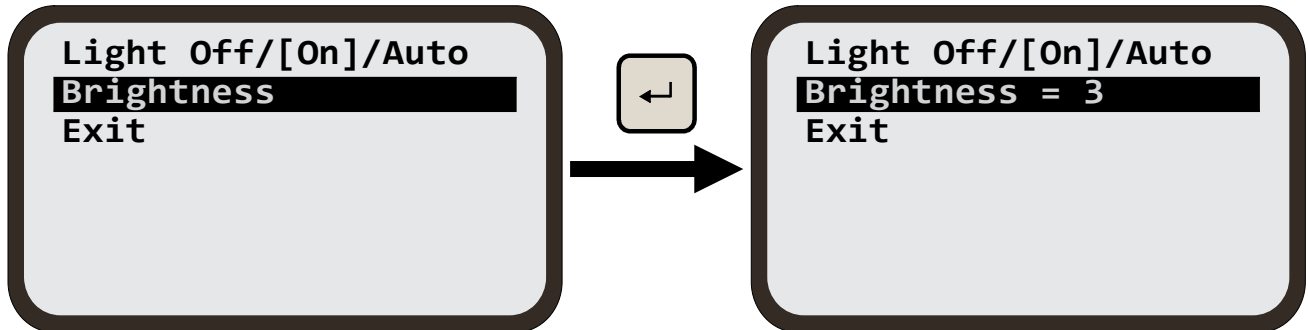

The setting will start to blink. Use [AUX] key to adjust the brightness between four different levels. Adjust the brightness to suit your eyes and cabin light conditions.

Press [ENTER] key when done.

LCD CONTRAST

In 'LCD/LED Settings submenu, use [AUX] key to highlight the Contrast setting and then press the [ENTER] key to bring up the current contrast setting.

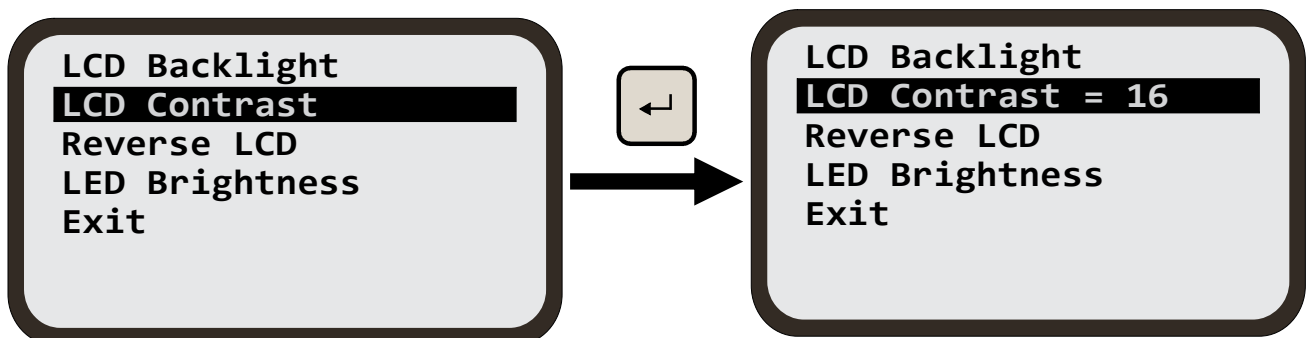

The setting will start to blink. Using [AUX] key, adjust the contrast to suit your eyes and cabin light conditions. Press [ENTER] key when done.



REVERSE LCD

Use [AUX] key to highlight the Reverse LCD setting then press [ENTER] key to reverse the default LCD colour settings.

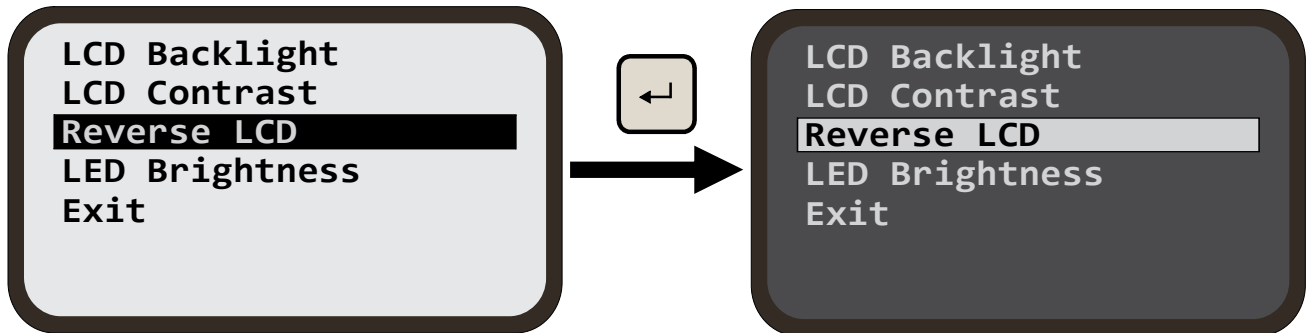

LED BRIGHTNESS

Using [AUX] key to highlight the LED brightness setting then press [ENTER] key to show the current LED brightness level.

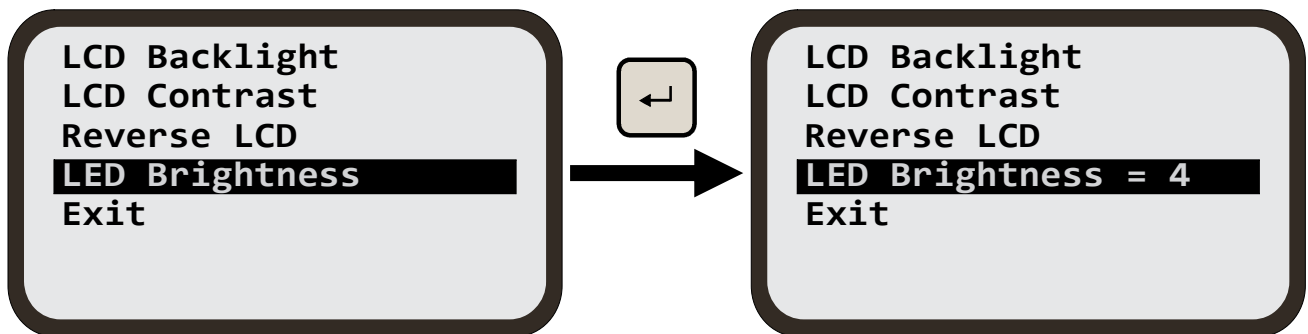

The LED brightness setting will start to blink and the panel LEDs will turn ON to show the brightness.

Using [AUX] key, adjust the LED Brightness to suit your eyes and cabin light conditions.

Press [ENTER] key when done.





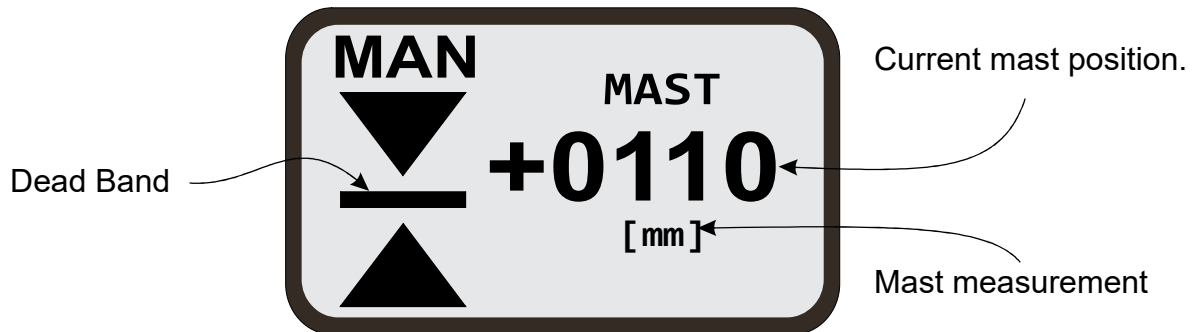

5.4 MAST MODE OF OPERATION

5.4.1 MAST WORKING SCREEN

If the mast is connected, the mast working screen is displayed as shown. The image below shows the current position of the mast in mm.



5.4.2 MAST FUNCTION KEYS

-  - Open the reference screen.
-  - Set current mast position as zero.
-  - Press to invoke the mast reference settings.
-  - Move the mast up or down manually.
- 



5.4.3 ADJUSTING MAST POSITION

Basic mast position adjustment is done with [AUX2] key. Pressing [ZERO] key will set the current mast position to zero.

The reference menu allows to program and memorise 4 positions for quick use in quick position change.

To access the reference menu press the [REF] key from the mast working menu then select a reference slot.

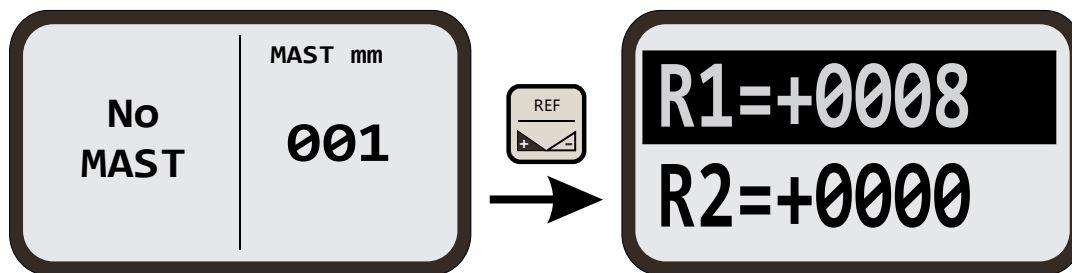

After selecting a reference slot press [ENTER] key and the selection will flash. Use [AUX2] key to select and set a new reference point, then press [ENTER] key to confirm the new reference point setting.

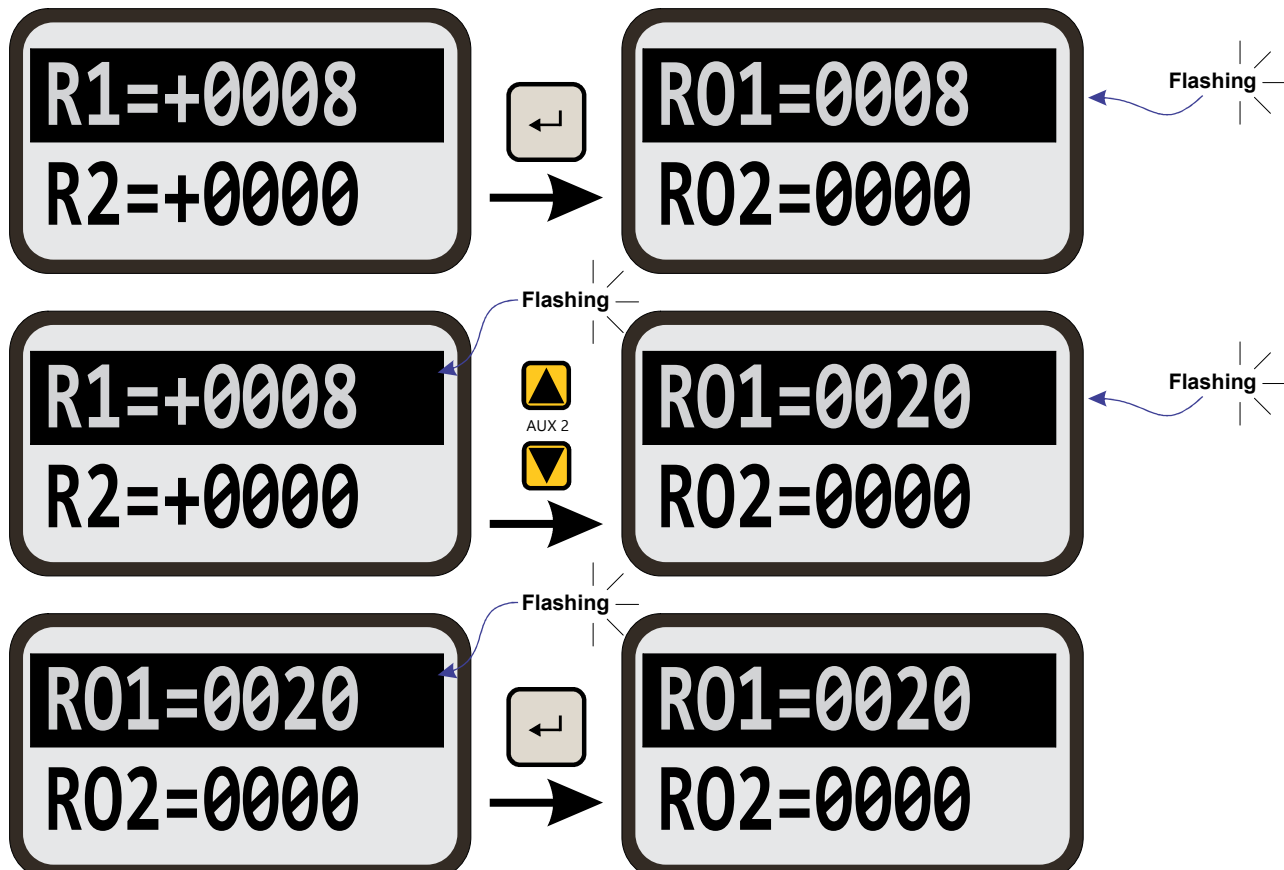



5.4.4 RELATIVE OFFSET

USING THE PANEL KEYS

The mast can be adjusted to an offset value that is setup in the mast reference offset (RO1 and RO2). To set the offset value;

- 1) Press the [REF] button from the mast working screen.
- 2) Scroll down using the [AUX2] down arrow to select either RO1 or RO2.
- 3) Press the [ENTER] button to enable changes in value to be made.
- 4) Once the value for RO1 and RO2 are set, scroll down using [AUX2] down arrow to exit and press [ENTER] or simply press the menu button to go back to the mast working screen.

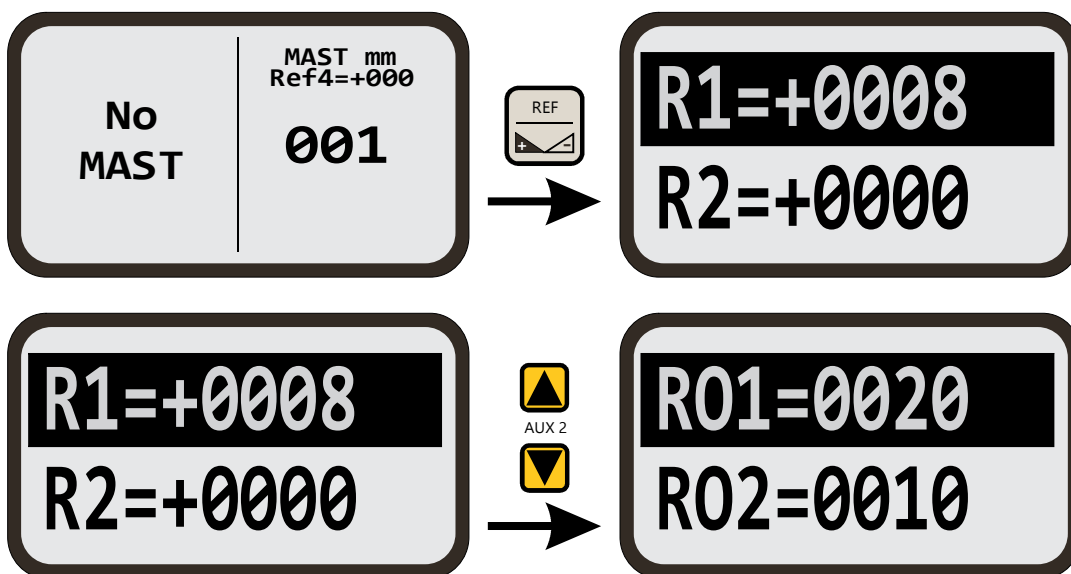

To adjust the mast height by RO1 offset;

- 1) Press and hold [REF] button then press the [AUX2] up or down arrow key once to increase or decrease the mast height.
- 2) Upon the release of the [REF] button the mast will move up or down to a value equal to RO1 offset.

To adjust the mast height by multiple of RO1 offset;

- 1) Press and hold the [REF] button then press the [AUX2] up or down arrow key multiple times.
- 2) Upon the release of the [REF] button, the mast will move up or down at a value equal to RO1 offset multiplied by the number of times the [AUX2] up or down arrow key was pressed. A maximum of 7 presses can be made.

Adjusting the mast height by RO2 offset is the same procedure as with adjusting the mast height by RO1 offset.



USING OPTIONAL JOYSTICK

An optional joystick can also be used to adjust the mast height by a relative offset, RO1 and RO2. Follow the steps below to take advantage of this feature.

*Note: Relative Offset RO1 and RO2 must **NOT** be set to zero for this function to work.*

The only type of joystick that works using this function is 'Prop Mini Stick/Mast'. To select this type, scroll down to 'Advanced Settings' while in the main menu. Press [ENTER] then scroll down to row 3 for joystick type using [AUX2] down arrow key. Press [ENTER] key to scroll through different types until 'Prop Mini Stick/Mast' is selected. Exit back to the mast working screen.

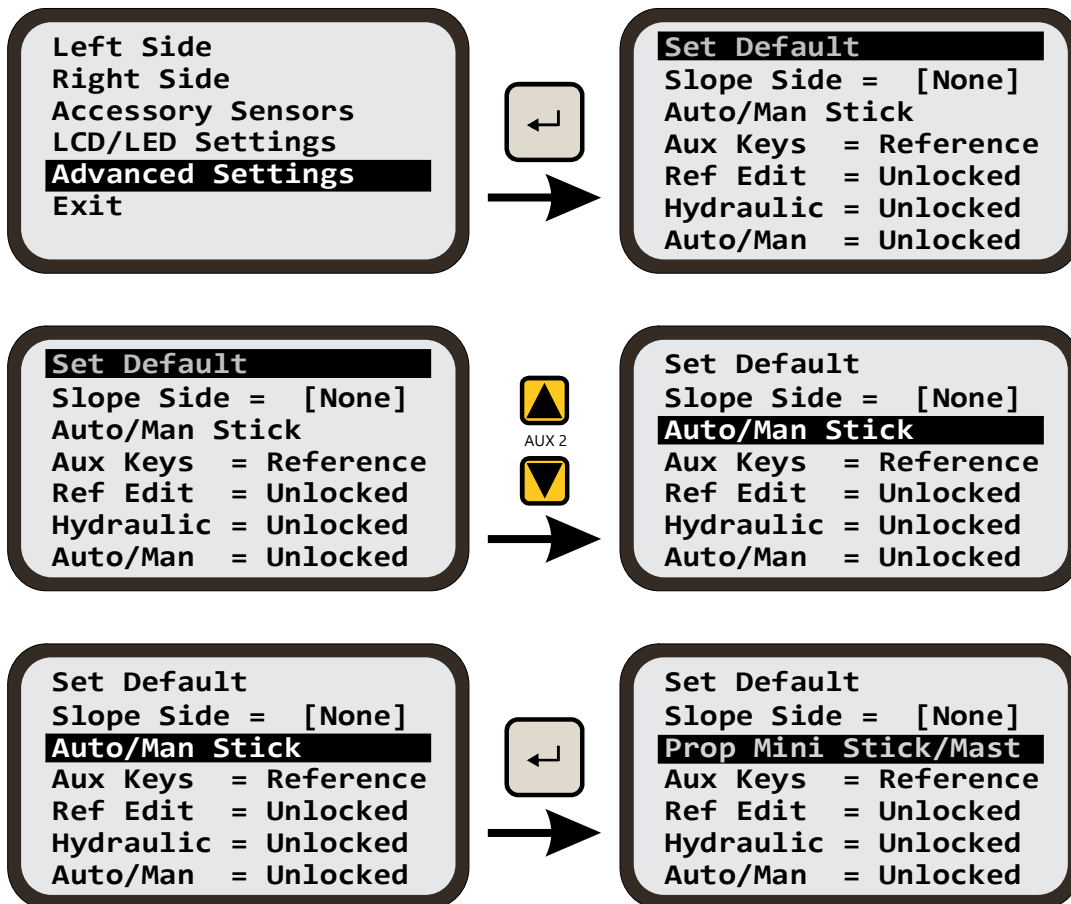

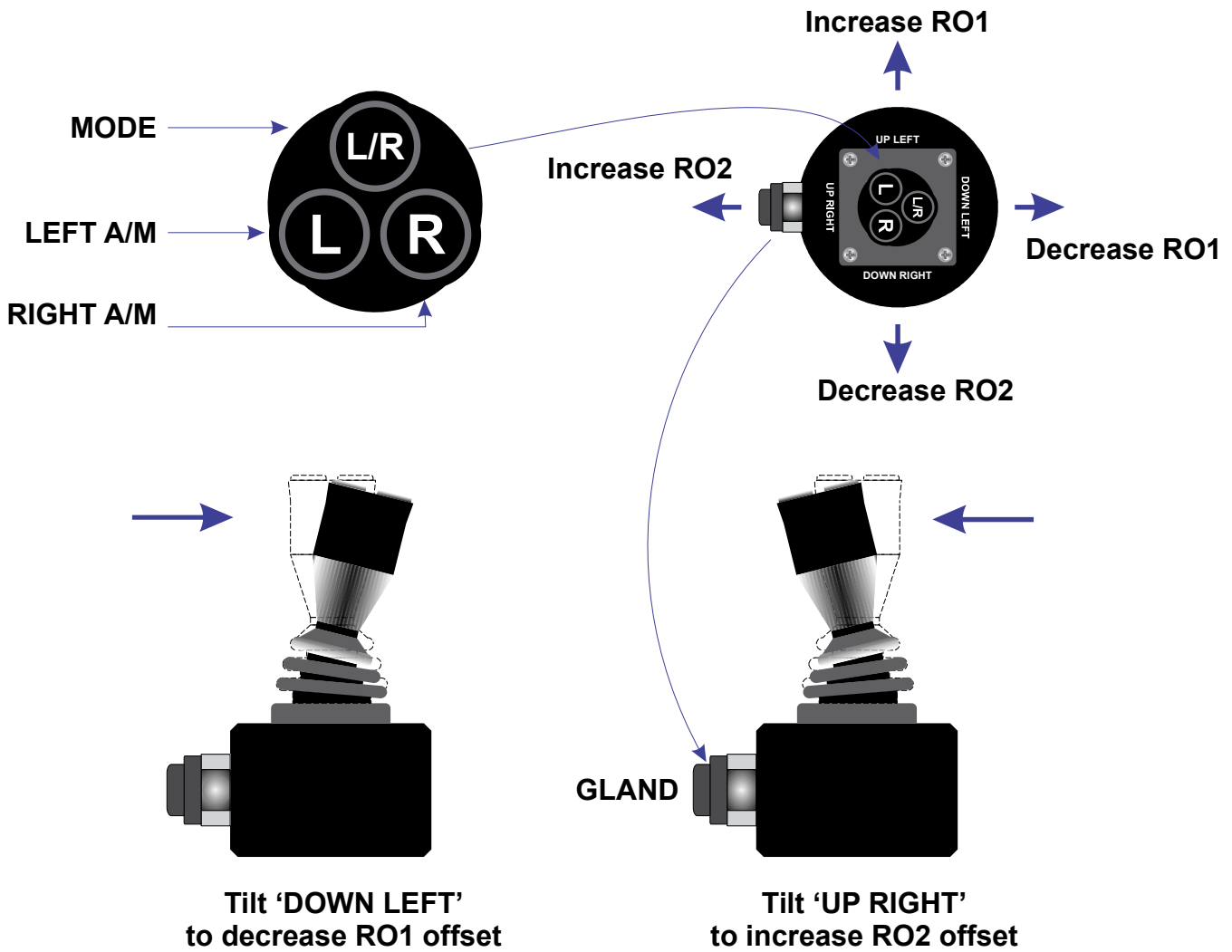

To increase the mast height by RO1 offset, press and hold [L/R] button then tilt the joystick towards 'UP LEFT' position. While holding the [L/R] button, go back to the neutral position and release the [L/R] button.

To decrease the mast height by RO1 offset, press and hold [L/R] button then tilt the joystick towards 'DOWN LEFT' position. While holding the [L/R] button, go back to the neutral position and release the [L/R] button.

To increase or decrease the mast height by multiple of RO1 offset, press and hold [L/R] button then tilt the joystick towards 'UP LEFT' or 'DOWN LEFT' position and back to neutral position multiple times while holding the [L/R] button. In neutral position, release the [L/R] button to activate. A maximum of 7 tilts can be applied.

Adjusting the mast height by RO2 offset is the same procedure as with adjusting the mast height by RO1 offset. The only difference is the joystick has to be tilted towards 'UP RIGHT' or 'DOWN RIGHT' position.







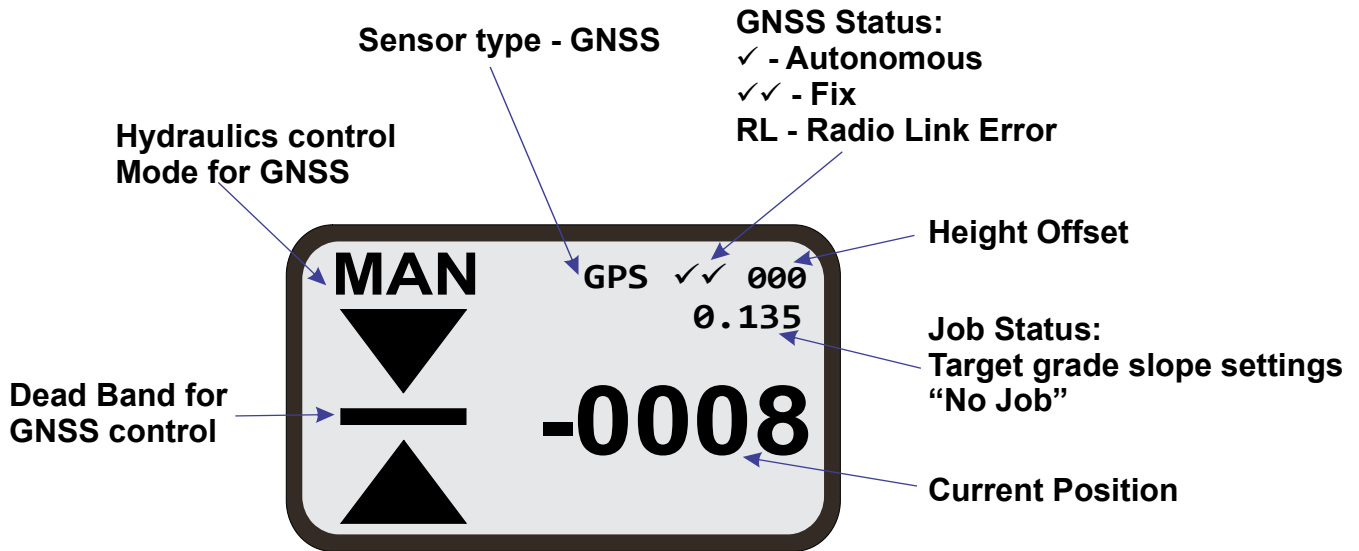

5.5 GNSS MODE OF OPERATION

5.5.1 GNSS WORKING SCREEN

The GNSS sensor is always shown on the left side of the working screen. All the information and settings related to GNSS are shown in the typical example below with the GNSS in a fixed state and control panel in manual mode of operation.



5.5.2 GNSS FUNCTION KEYS

- 
 - Job type selection
 - Job target settings
- 
 - Move up and down to trim height offset
- 
 - Short press both switches to copy current height position to offset
- 
 - Long press both switches to reset height and offset to zero
- 
 - Zero GNSS height and offset
- 
 - Edit and select height reference memory settings



5.5.3 GNSS JOB TYPE SELECTION & SETUP

Press the [ENTER] key to bring up the job selection menu. Select the job type and follow instructions to setup the job direction.

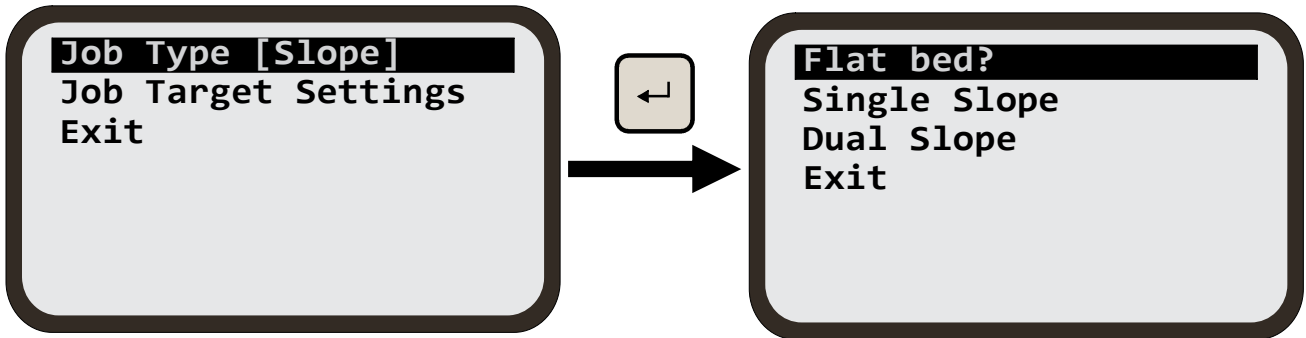

To set the job direction enter the position of the two reference points A & B using the following instructions.

Note: For the single & dual slopes provide a minimum distance of 10m between reference points A & B to define accurately the orientation of slope targets.

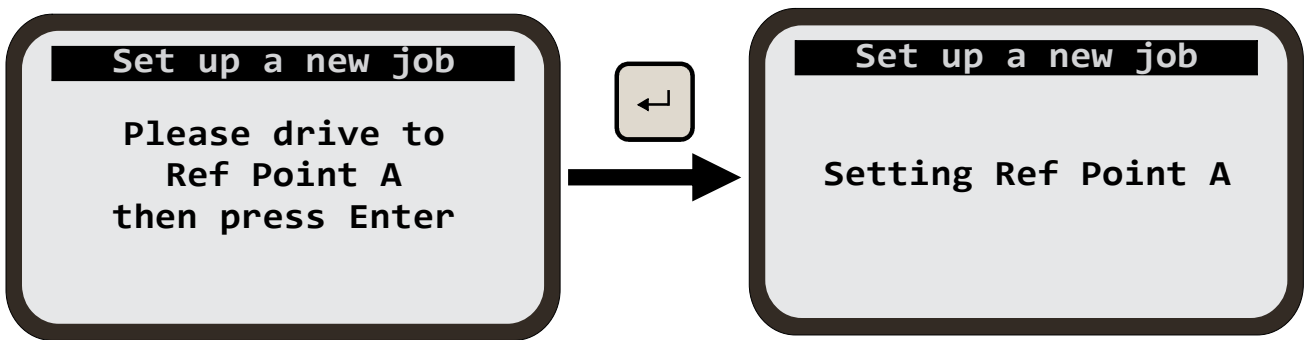

Continue with these same steps to set up reference point B.

Confirm that the job setup has been successfully completed.

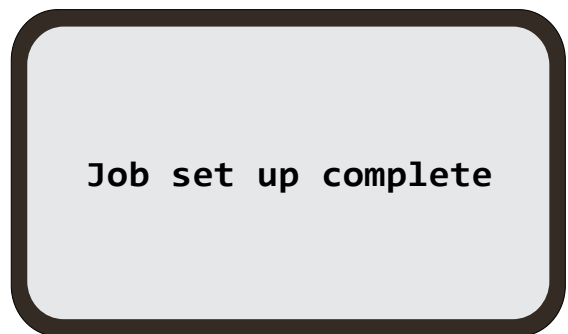

For Single Slope and Dual Slope go to the job target settings and dial using the [AUX] key to configure the required slope settings.

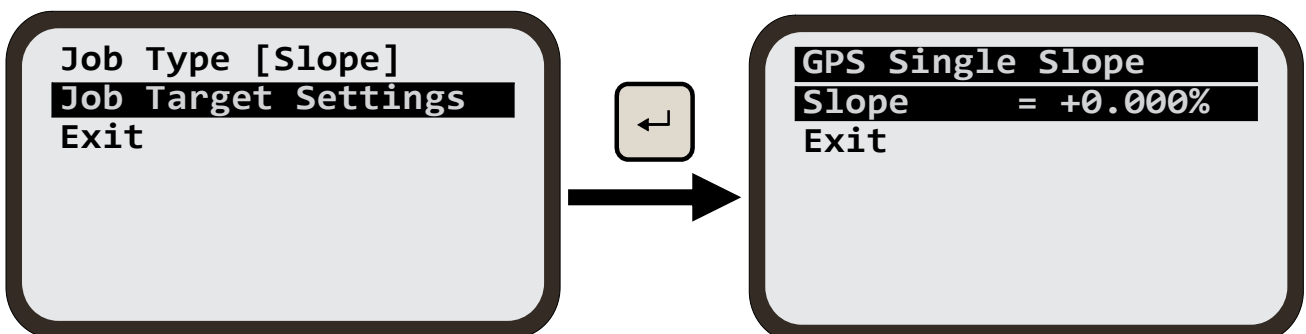



5.6 RESET TO SYSTEM DEFAULT

From the main menu screen use [AUX] key to select 'Advance Settings' and press [ENTER] key then follow configuration below.

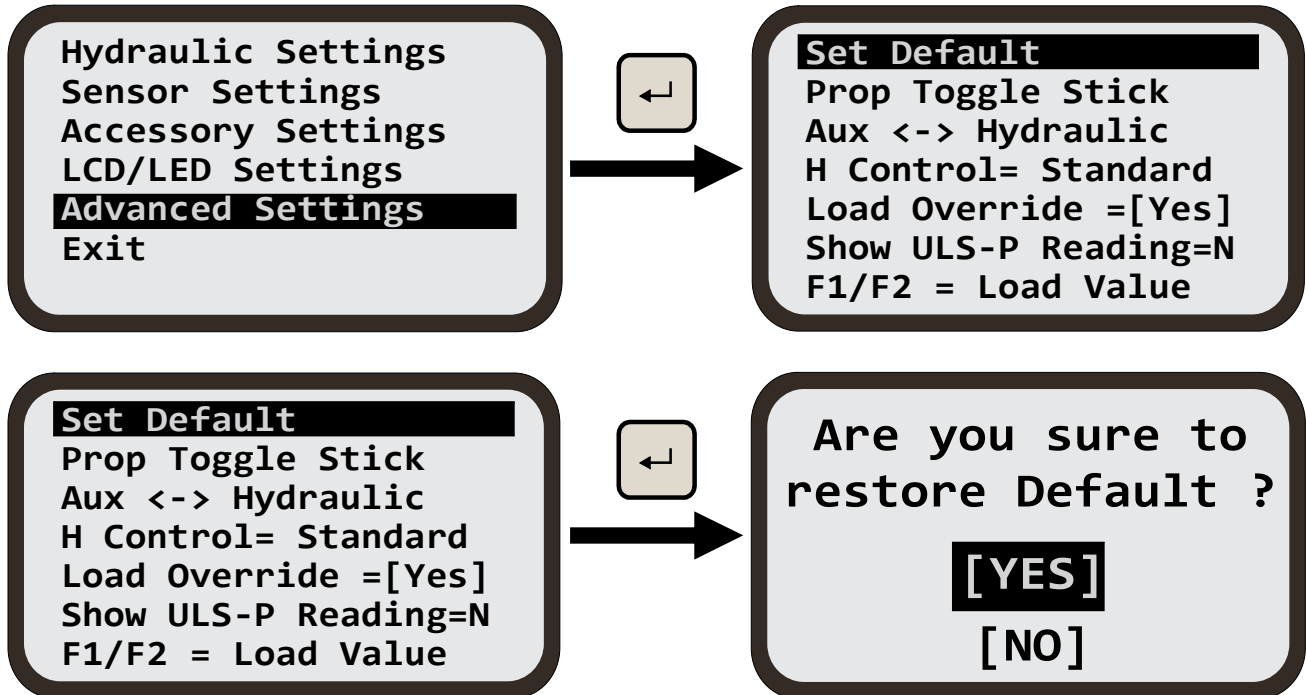

To avoid accidental resetting of the system to factory defaults, you will be asked to confirm your selection. Select 'NO' if you do not want to proceed and press the [ENTER] key to exit. Select 'YES' if you want to proceed with system default. Press the [ENTER] key to execute.

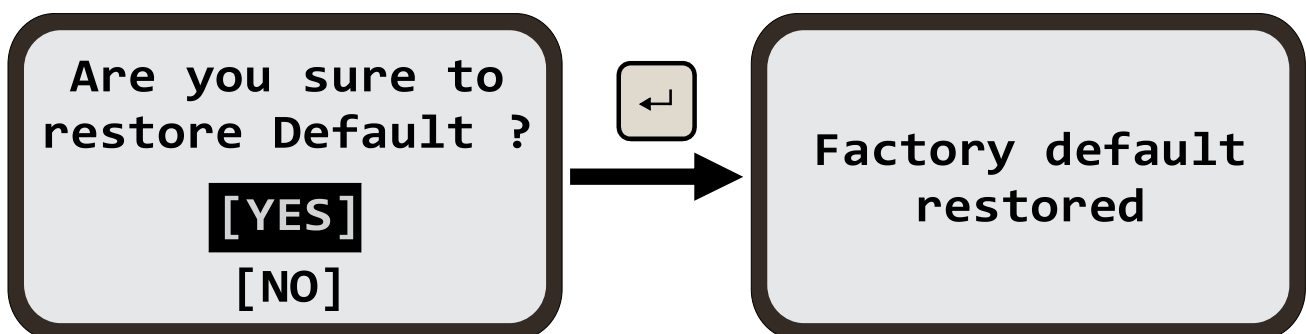

Screen will return to the main menu screen after displaying 'Factory default restored' screen for five seconds.

6. JOYSTICK TYPE (optional)

CBD2 supports multiple types of joysticks, so it is very important to select the right type of joystick connected to the system.

From the main menu screen use [AUX] key to select 'Advance Settings' and press [ENTER] key.

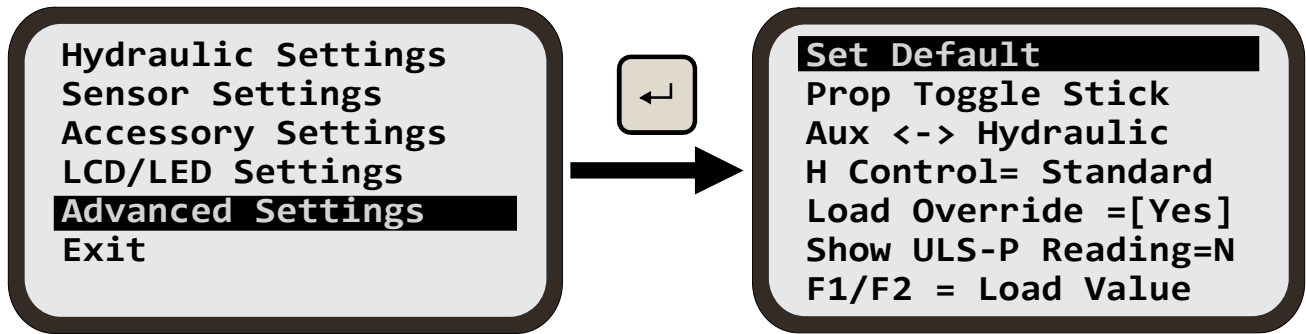

Scroll down to the second line and press [ENTER] until the desired joystick is selected. Scroll down to exit and press [ENTER] to go back to the main menu.

The different types of joystick supported are:

(a) Side Mini Stick (default) -

- (i) hydraulic up and down activations are located on an axis 90 degrees to each other on the joystick handle.
- (ii) Hydraulic activation is proportional to handle position.
- (iii) Includes 3 buttons on top for switching between Auto and Manual:

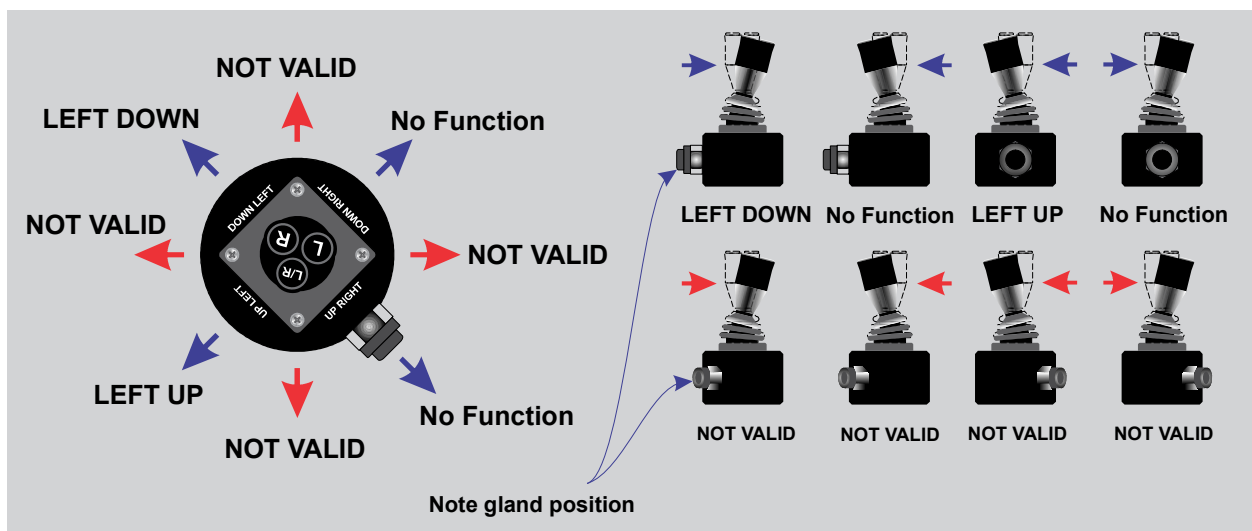
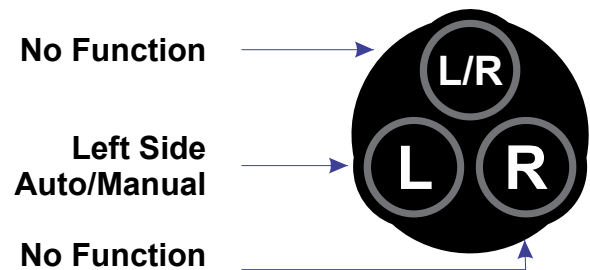



(b) Side Mini & Aux Stick - as above with an additional auxiliary hydraulic activation function. This additional auxiliary hydraulic is activated by pressing the L/R button.

(c) Proportional Mini Stick -

- (i) hydraulic up and down activations are located on the same axis on the joystick handle.
- (ii) Hydraulic activation is proportional to handle position.
- (iii) Includes 3 buttons for switching between Auto and Manual as per side mini stick.

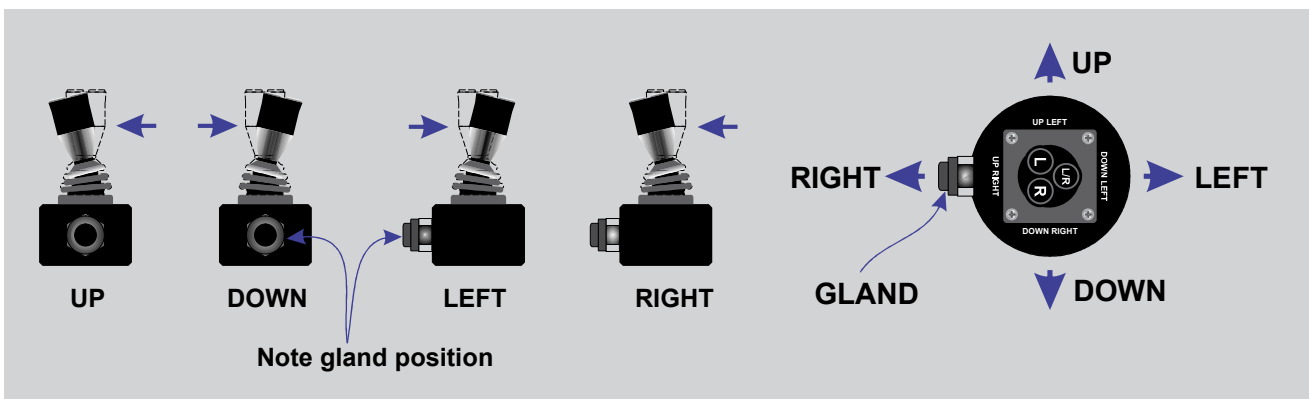

(d) On Off Mini Stick -

- (i) hydraulic up and down activations are located on the same axis on the joystick handle.
- (ii) Hydraulic activation is not proportional to handle position. Simple ON/OFF activation.
- (iii) Includes 3 buttons on top for switching between Auto and Manual (see fig. 63 on page 49).

(e) Proportional Toggle Stick - works in the same manner as 'Proportional Mini Stick', however power supply and signal out levels differ to accommodate DANFOSS type proportional joysticks (not limited to this brand).

(f) On Off Toggle Stick - works in the same manner as 'On Off Mini Stick', however power supply and signal out levels differ to accommodate DANFOSS type ON/OFF joysticks (not limited to this brand).



(g) Auto/Man Stick - this joystick uses a toggle switch rather than a handle for hydraulic activation and another toggle switch for 'Auto/Manual' selection. Available only for left side.

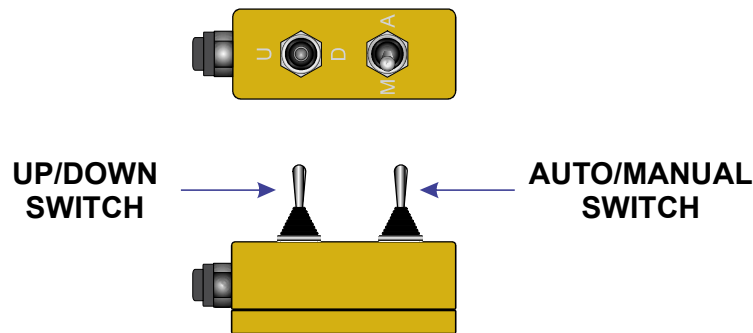

Note: With this option, the [A/M] key on the control panel will not work in the manner described in section 4.2 because the connected joystick will override this button. If no joystick is being used, select 'Side Mini Stick' (the default option).

(h) Mast Offset Stick -

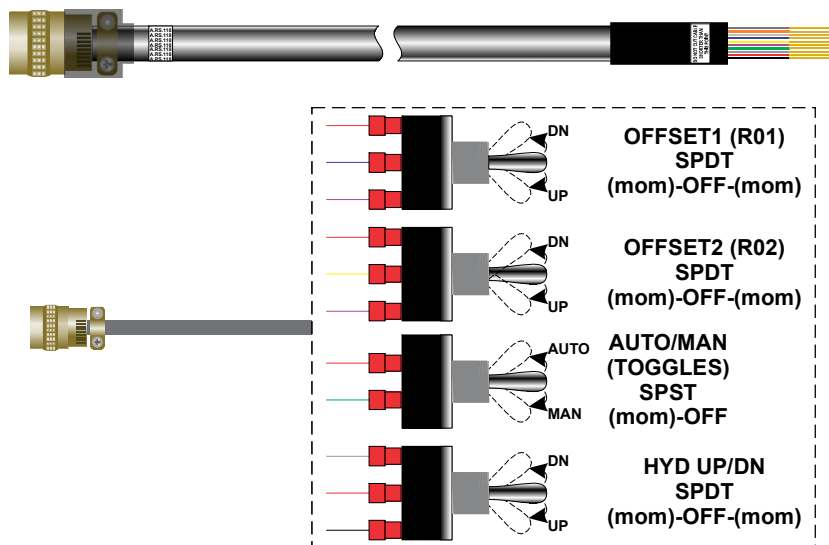

Note: Only cable with bare wires is provided. The switches are **optional**.

(I) Proportional Mini Stick/Mast -



7. HP Load Sensor (Optional)

The HP Load Sensor is an optional accessory sensor that is used for load monitoring of towed scraper buckets. It comes in the form of a clevis or pivot pin and is intended as a direct replacement of such pins with the additional feature of being able to measure the load being towed by the scraper machine.

The purpose of the HP Load Sensor is to allow override of automatic hydraulic control whenever the bucket load exceeds a preset value that's set by the user. During override the bucket is automatically lifted until the load reduces by an amount that is also preset by the user. At the end of override, automatic hydraulic control returns to normal.

This feature is not available in 'Manual' mode of hydraulic control.

General Setup

The overall connection setup for the CB.D2 with HP Load Sensor is illustrated below.

SET UP DIAGRAM FOR RS.032b

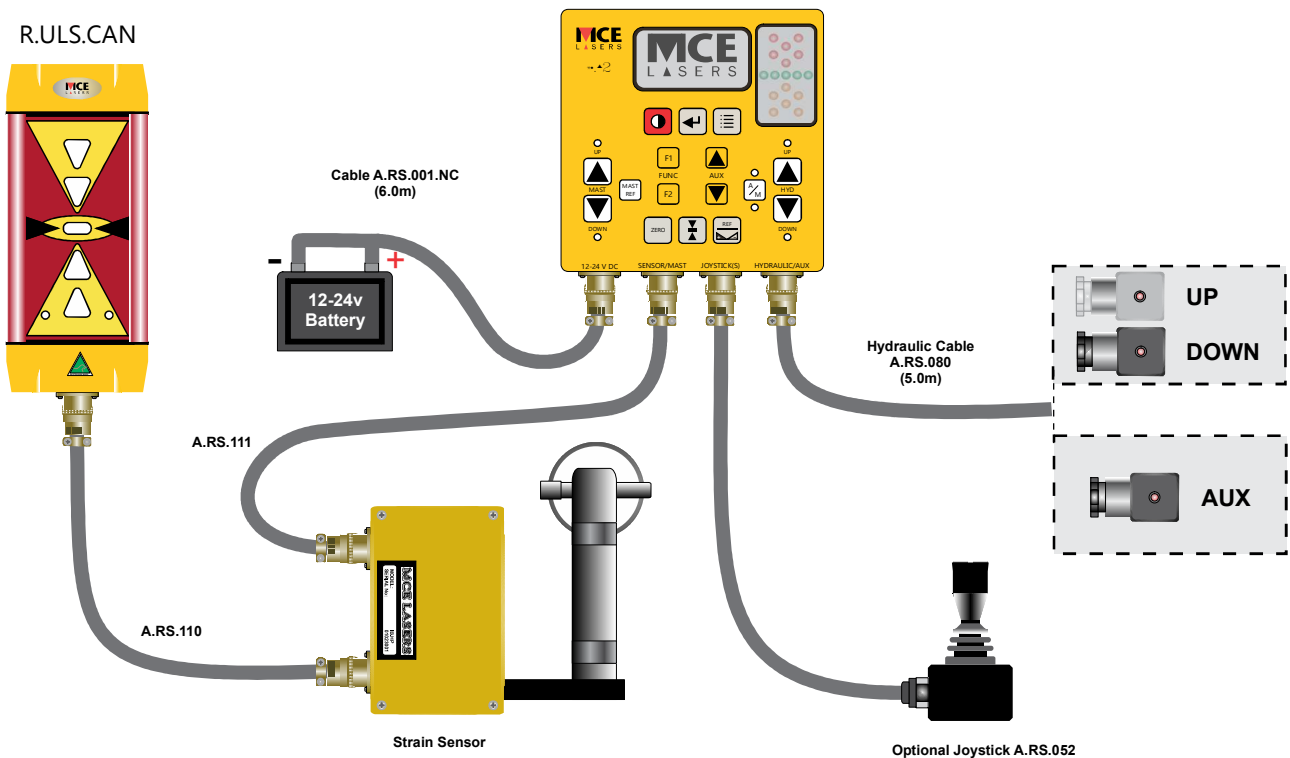



7.1 Switching HP Load Feature On

Press [MENU] key, select 'Advanced Settings' and press [ENTER] key.

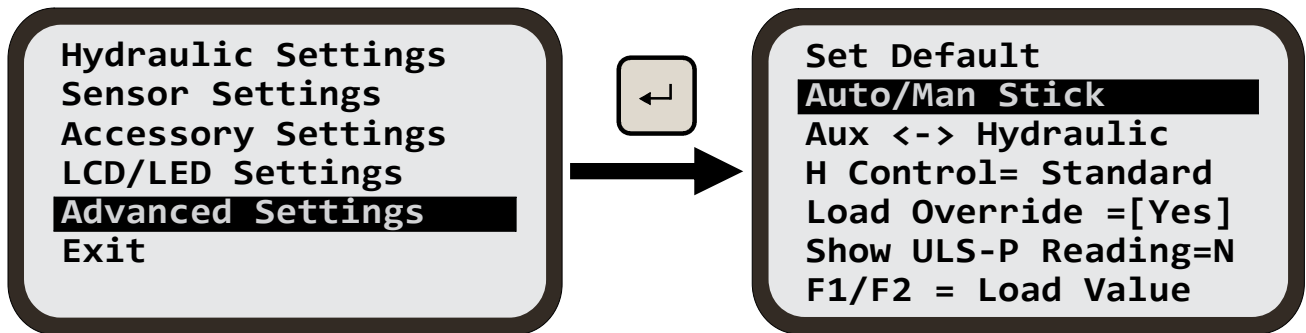

Select option 'Load Override = [No]' and press [ENTER] button. Option should flick to 'Yes' as shown below.
Select 'Exit' and press [ENTER] to exit the menu.

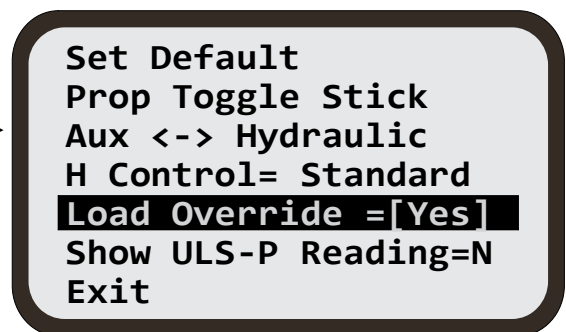

Setting the Load Override Activation Threshold

Press the [FUNC] up or down buttons. The current Load Override Activation Threshold is displayed as shown below.

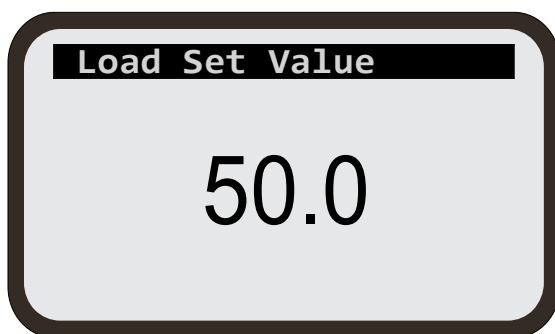

Use the [FUNC] up or down buttons to adjust the threshold to the desired level. The display returns to the standard screen after a few seconds of user inactivity. The desired level is usually job dependent and is determined by the user by trial and error at the start of a new job.

The Load Override Activation Threshold can alternatively be set through the menu:

Press [MENU] button.
Select 'Accessory Settings' and press [ENTER] button.

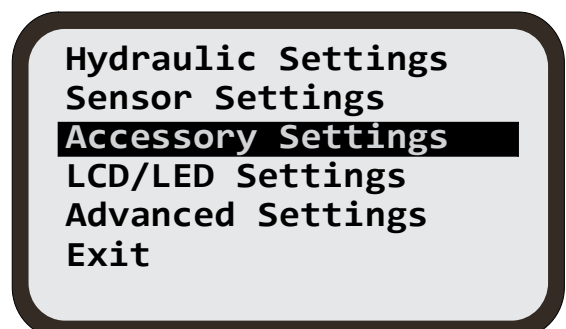



Select 'Sensor Settings' and press [ENTER] button.

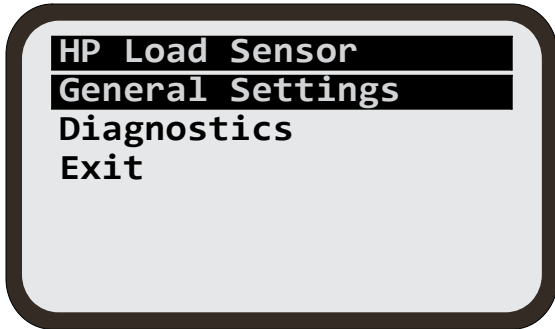
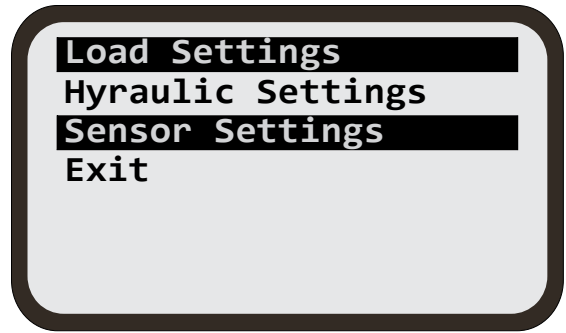
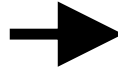

Select 'General Settings' and press [ENTER] button.



Select 'Set Value' and press [ENTER] button.
 Use the [AUX] up or down buttons to adjust the threshold.
 Press [ENTER] button to exit editing mode.
 Press [MENU] button to return to the standard screen.

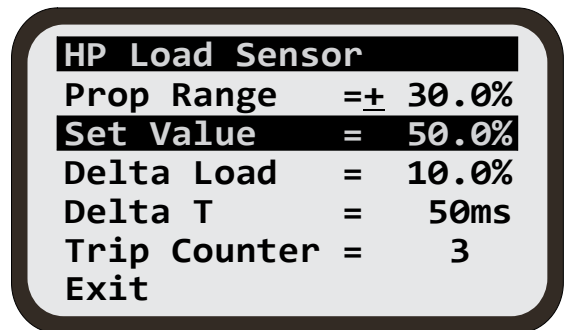

Setting the Load Override Deactivation Threshold

The Load Override Deactivation Threshold is given as a difference from the Activation Threshold. This means that if it is set to 10%, the load override will deactivate when the load is below the activation threshold by an amount of 10% of maximum load.

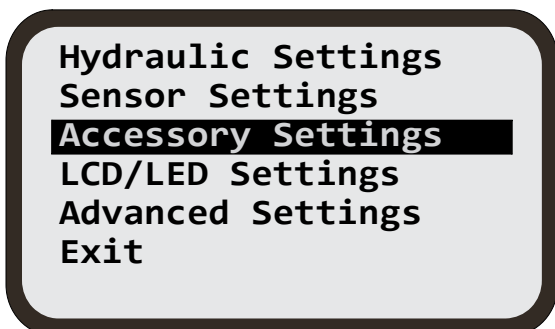

To set this threshold:

Press [MENU] button.
 Select 'Accessory Settings' and press [ENTER] button.
 Select 'Sensor Settings' and press [ENTER] button.



Select 'Sensor Settings' and press [ENTER] button.

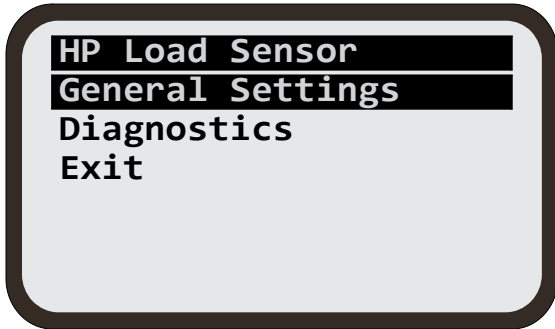
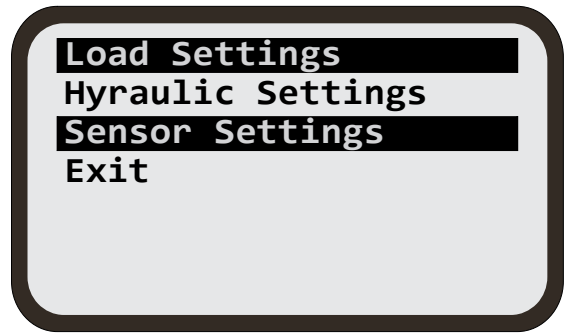
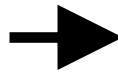

Select 'General Settings' and press [ENTER] button.

Select 'Delta Load' and press [ENTER] button.

Use the [AUX] up or down buttons to adjust the threshold.

Press [ENTER] button to exit editing mode.

Press [MENU] button to return to the standard screen.

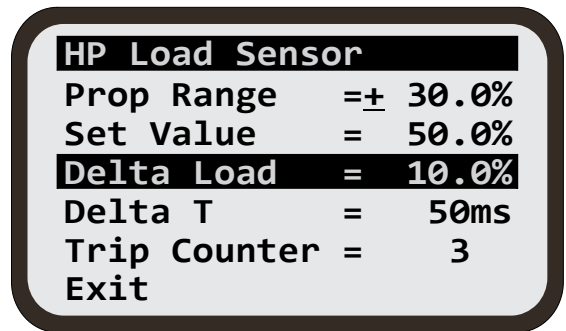

Setting the Load Override Activation Threshold

There are an additional five settings that can be adjusted for the HP Load Sensor: 'Dead Band', 'Prop Range', 'Delta T', 'Trip Counter' and 'Set Zero'. The first four can be adjusted through the same menu as for setting the thresholds outlined above.

'Dead Band': Sets the upper and lower range (band) for the override deactivation threshold.

'Prop Range': Sets the range of HP Load Sensor reading where the hydraulic output during override is controlled proportionally to sensor reading.

'Delta T': Sets the sampling interval for load sensor measurements.

'Trip Counter': Sets the number of consecutive times the override threshold should be exceeded before override mode activates or deactivates.

The fifth setting, 'Set Zero' is normally a factory set setting for initial calibration of the HP Load Sensor with zero load. The user should not normally have to use this setting.



Setting the Hydraulic Behaviour During HP Load Override

The hydraulic behaviour during override can be set through the menu.

Press [MENU] button
 Select 'Accessory Settings' and press the [ENTER] button.

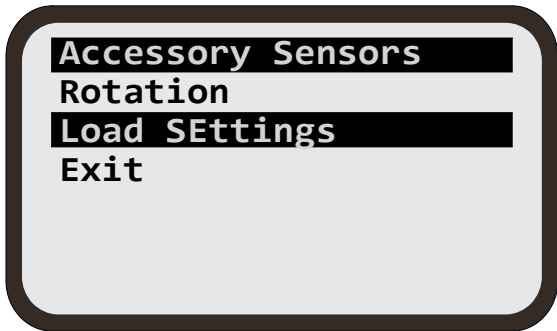
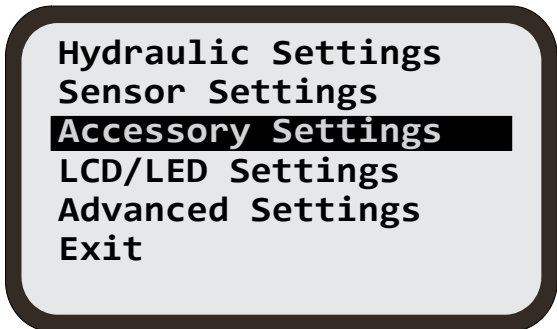

Select 'Load Settings' and press the [ENTER] button

Select 'Hydraulic Settings' and press the [ENTER] button.

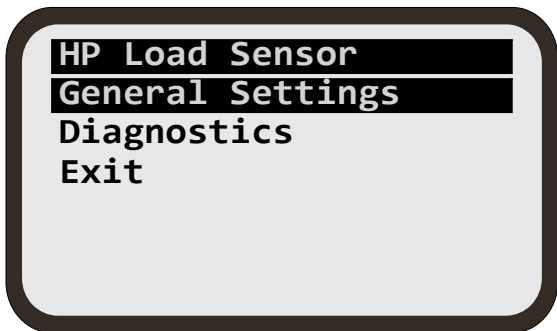
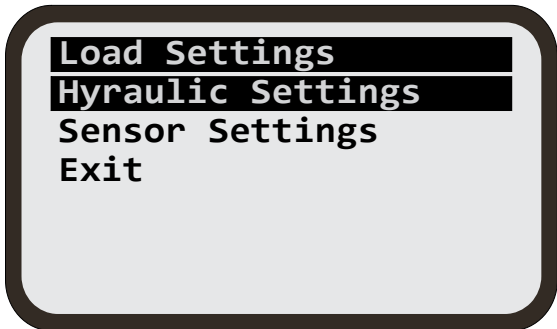

Select 'General Settings' and press the [ENTER] button.

Depending on the hydraulic type selected for normal operation, a settings menu will appear tailored to the type of hydraulic. For example, for Voltage Proportional [VO] type, the following menu will appear.

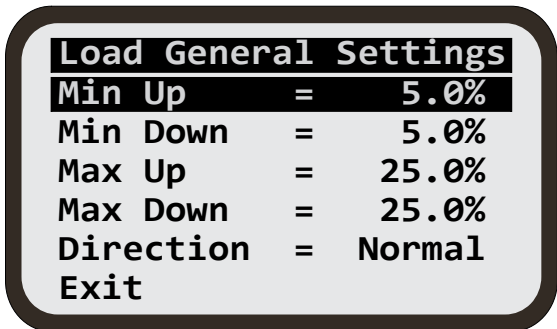

All these settings have the same meaning as for normal operation and should be set according to the same instructions.



8 PRACTICAL EXAMPLE

The following example is provided to help demonstrate how setting reference offsets, zeroing and mounting would be done in practice. This example involves a Trace sensor.

Assume the grading requirement is to maintain a relative distance of -50 mm between the cutting edge of the blade and the top of the curb as shown in Figure below.

The user has two ways of achieving the same outcome (please note that the CB.D2 should be in manual mode for hydraulic control during the setup phase).

OPTION 1:

1. Position the cutting edge of the blade and the Trace sensor as shown, ie, the cutting edge of the blade 50 mm below the top of the curb and the ultrasonic sensor 330-370 mm above the curb (the sensor distance to the curb can be read on the screen while in **Absolute** measurement mode).
2. Set the current offset for the blade to zero.
3. Zero the sensor reading.
4. Switch to AUTO hydraulic control to begin.

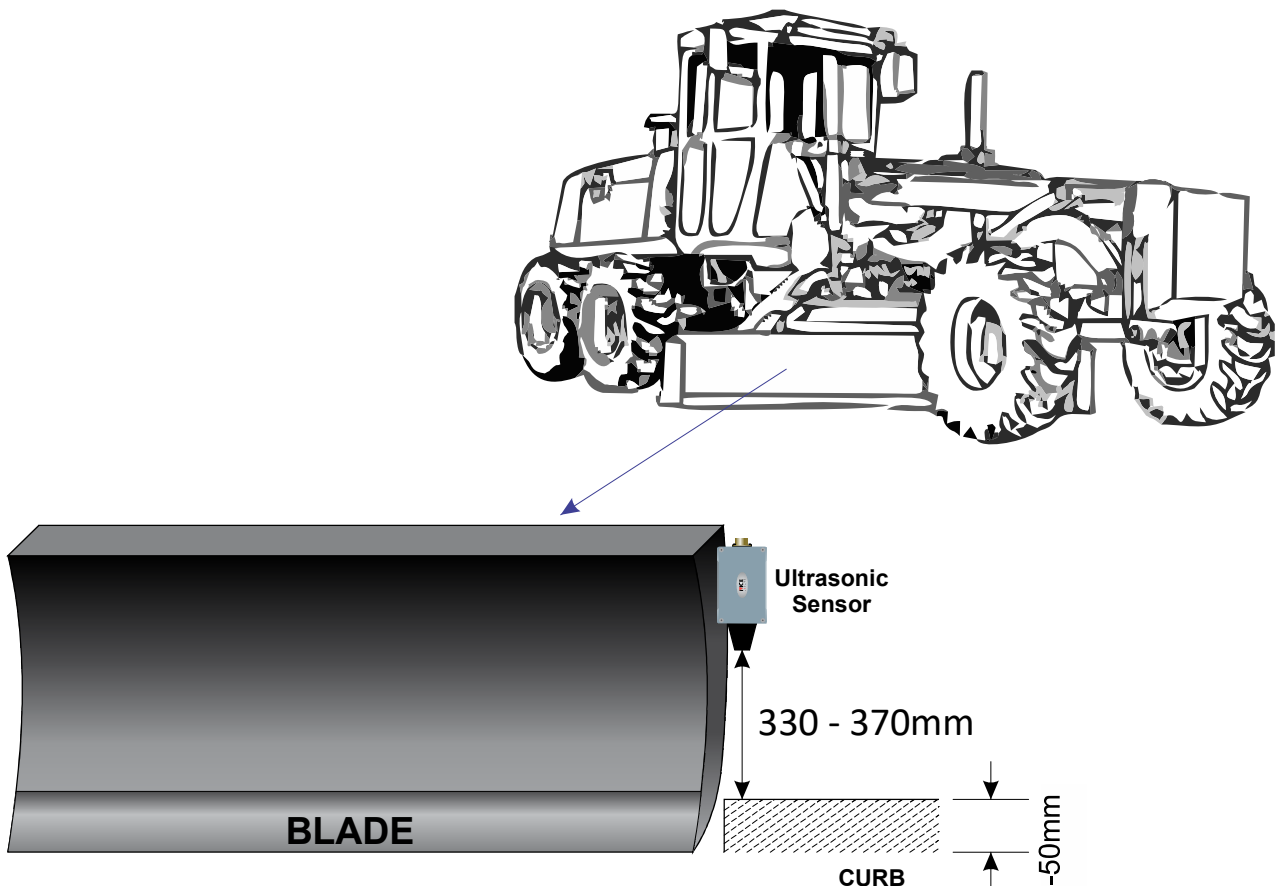



OPTION 2:

1. Position the cutting edge of the blade to be level with the top of the curb and the ultrasonic sensor to be above the curb as shown in the illustrations below. The ultrasonic sensor should be approximately 380-420 mm above the curb (that is, 50 mm above the desired sensor range of 330-370 mm during normal grading operations).
2. Set the current offset for the blade to -50 mm.
3. Zero the sensor reading.
4. Switch to AUTO hydraulic control to begin. The blade will immediately be lowered by 50 mm so that the reading matches the set offset. This will also bring the ultrasonic sensor to a distance of 330 – 370 mm from the curb which is the desired range during normal grading operations.

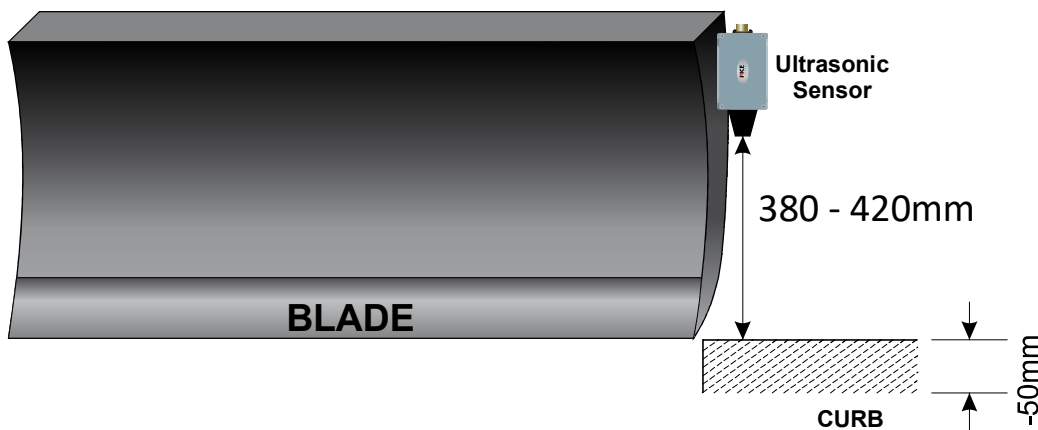

Option 2 should only be used in cases where the desired offset is less than ± 80 -120 mm so that the tracer is kept within its operating range of 250 - 450 mm when it is mounted in step 1.

In the example above, if the required offset was -200 mm instead of -50 mm, the tracer would have had to be mounted 530 - 570 mm above the curb initially (200 mm above the desired sensor range of 330-370 mm during normal grading operations). This would have put it above its maximum operating range of 450 mm.

Similarly, if the sensor was mounted at 450 mm above the curb initially, it would have ended up at 250 mm when the blade was lowered by 200 mm in step 4. This would have put it right at its minimum operating range which is also not desirable during normal grading operations.



THIS PAGE IS INTENTIONALLY LEFT BLANK.



MOBA MOBILE AUTOMATION AUSTRALIA PTY LTD

ABN - 866 279 713 68

90 Willandra Drive, Epping, Victoria, Australia 3076

Ph: +61 3 9357 0055 Email: aumoba@moba.de

www.moba-automation.com.au